

---

# FLEX 8

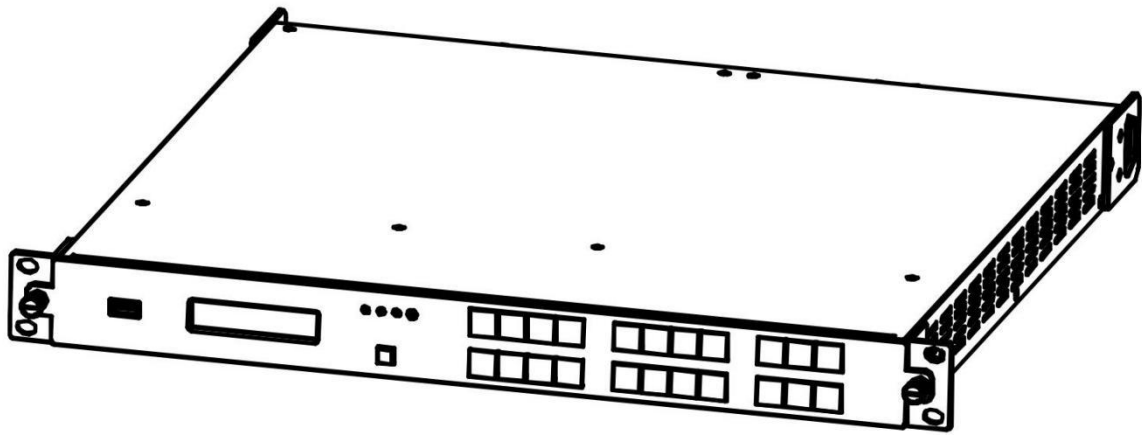

## USER MANUAL

# RGBlink<sup>®</sup>

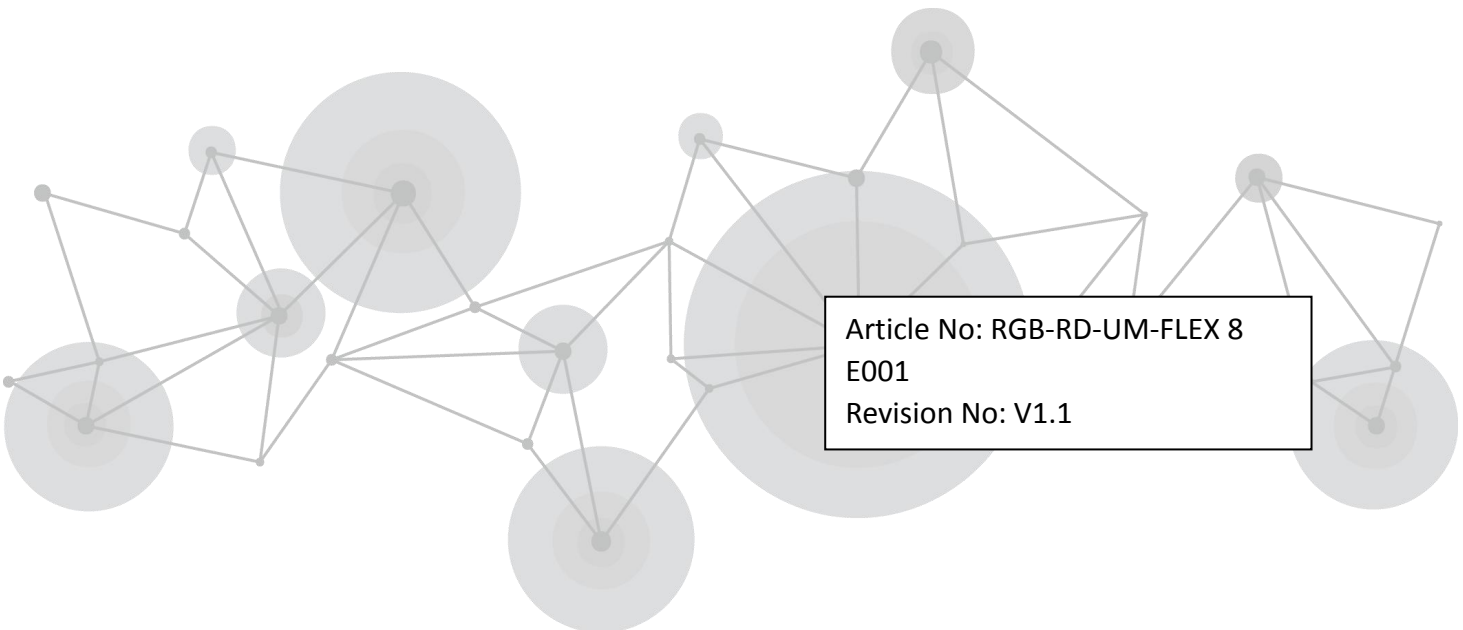

Article No: RGB-RD-UM-FLEX 8  
E001  
Revision No: V1.1

---

# CONTENTS

<i>Declarations</i> .....	2
FCC/Warranty.....	2
Operators Safety Summary.....	3
Installation Safety Summary.....	3
<i>Chapter 1 Your Product</i> .....	5
1.1 In the Box.....	5
1.2 Product Overview.....	6
1.2.1 Basic Front Panel.....	7
1.2.2 Matrix Front Panel.....	8
1.2.3 Back Panel.....	9
1.2.4 Dimension.....	10
<i>Chapter 2 Install Your Product</i> .....	11
2.1 Plug in Signals.....	11
2.2 Plug in Main Power.....	11
<i>Chapter 3 Use Your Product</i> .....	12
3.1 Matrix Panel Operation.....	12
3.1.1 MENU Operation.....	12
3.1.2 Button Operation.....	14
3.2 XPOSE Control FLEX 8.....	16
3.2.1 Install Software.....	16
3.2.3 Login to the Software.....	19
3.2.4 Connect to Software.....	20
3.2.5 Output Setting.....	22
Output setting.....	23
choose output resolution here.....	23
DE Setting.....	24
3.2.6 Operation Mode.....	25
Matrix Mode.....	25
Splitting Mode.....	29
3.2.7 System Settings.....	46
3.2.8 Logout.....	49
<i>Chapter 4 Ordering Codes</i> .....	50
4.1 Product.....	50
4.2 Modules.....	50
4.2.1 Input.....	50
4.2.2 Output.....	50
4.2.3 Others.....	50
<i>Chapter 5 Support</i> .....	51
<i>Chapter 6 Appendix</i> .....	52
6.1 Specification.....	52
6.2 Terms & Definitions.....	57
6.3 Revision History.....	62

---

**Thank you for choosing our product!**

**This User Manual is designed to show you how to use this video processor quickly and make use of all the features. Please read all directions and instructions carefully before using this product.**

## *Declarations*

### *FCC/Warranty*

#### **Federal Communications Commission (FCC) Statement**

This equipment has been tested and found to comply with the limits for a class A digital device, pursuant to Part 15 of the FCC rules. These limits are designed to provide reasonable protection against harmful interference when the equipment is operated in a commercial environment. This equipment generates, uses, and can radiate radio frequency energy and, if not installed and used in accordance with the instruction manual, may cause harmful interference to radio communications. Operation of this equipment in a residential area may cause harmful interference, in which case the user will be responsible for correcting any interference.

#### **Guarantee and Compensation**

RGBlink provides a guarantee relating to perfect manufacturing as part of the legally stipulated terms of guarantee. On receipt, the purchaser must immediately inspect all delivered goods for damage incurred during transport, as well as for material and manufacturing faults. RGBlink must be informed immediately in writing of any complains.

The period of guarantee begins on the date of transfer of risks, in the case of special systems and software on the date of commissioning, at latest 30 days after the transfer of risks. In the event of justified notice of compliant, RGBlink can repair the fault or provide a replacement at its own discretion within an appropriate period. If this measure proves to be impossible or unsuccessful, the purchaser can demand a reduction in the purchase price or cancellation of the contract. All other claims, in particular those relating to compensation for direct or indirect damage, and also damage attributed to the operation of software as well as to other service provided by RGBlink, being a component of the system or independent service, will be deemed invalid provided the damage is not proven to be attributed to the absence of properties guaranteed in writing or due to the intent or gross negligence or part of RGBlink.

If the purchaser or a third party carries out modifications or repairs on goods delivered by RGBlink, or if the goods are handled incorrectly, in particular if the systems are commissioned operated incorrectly or if, after the transfer of risks, the goods are subject to influences not agreed upon in the contract, all guarantee claims of the purchaser will be rendered invalid. Not included in the guarantee coverage are system failures which are attributed to programs or special electronic circuitry provided by the purchaser, e.g. interfaces. Normal wear as well as normal maintenance are not subject to the guarantee provided by RGBlink either.

The environmental conditions as well as the servicing and maintenance regulations specified in

---

this manual must be complied with by the customer.

## Operators Safety Summary

The general safety information in this summary is for operating personnel.

### **Do Not Remove Covers or Panels**

There are no user-serviceable parts within the unit. Removal of the top cover will expose dangerous voltages. To avoid personal injury, do not remove the top cover. Do not operate the unit without the cover installed.

### **Power Source**

This product is intended to operate from a power source that will not apply more than 230 volts rms between the supply conductors or between both supply conductor and ground. A protective ground connection by way of grounding conductor in the power cord is essential for safe operation.

### **Grounding the Product**

This product is grounded through the grounding conductor of the power cord. To avoid electrical shock, plug the power cord into a properly wired receptacle before connecting to the product input or output terminals. A protective-ground connection by way of the grounding conductor in the power cord is essential for safe operation.

### **Use the Proper Power Cord**

Use only the power cord and connector specified for your product. Use only a power cord that is in good condition. Refer cord and connector changes to qualified service personnel.

### **Use the Proper Fuse**

To avoid fire hazard, use only the fuse having identical type, voltage rating, and current rating characteristics. Refer fuse replacement to qualified service personnel.

### **Do Not Operate in Explosive Atmospheres**

To avoid explosion, do not operate this product in an explosive atmosphere.

## Installation Safety Summary

### **Safety Precautions**

For all FLEX 8 installation procedures, please observe the following important safety and handling rules to avoid damage to yourself and the equipment.

To protect users from electric shock, ensure that the chassis connects to earth via the ground wire provided in the AC power Cord.

---

The AC Socket-outlet should be installed near the equipment and be easily accessible.

## **Unpacking and Inspection**

Before opening FLEX 8 shipping box, inspect it for damage. If you find any damage, notify the shipping carrier immediately for all claims adjustments. As you open the box, compare its contents against the packing slip. If you find any shortages, contact your sales representative. Once you have removed all the components from their packaging and checked that all the listed components are present, visually inspect the system to ensure there was no damage during shipping. If there is damage, notify the shipping carrier immediately for all claims adjustments.

## **Site Preparation**

The environment in which you install your FLEX 8 should be clean, properly lit, free from static, and have adequate power, ventilation, and space for all components.

---

# Chapter 1 Your Product

---

## 1.1 In the Box

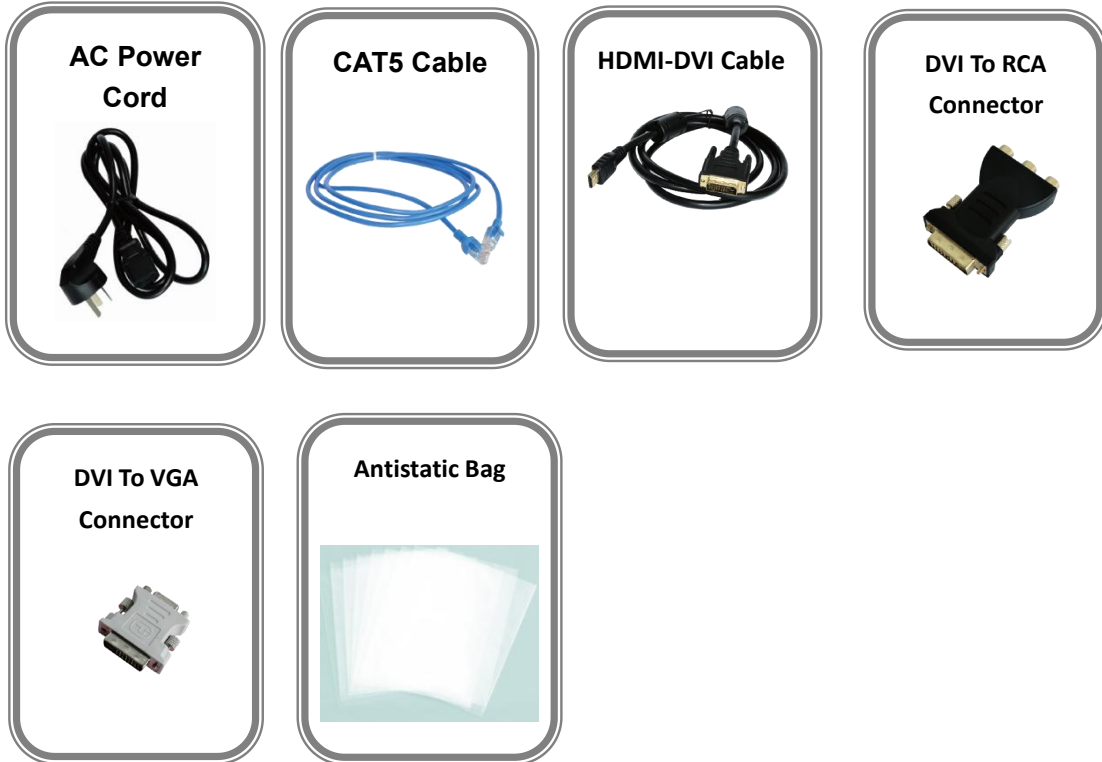

**Note:**

AC Power Cable supplied as standard according to destination market.

---

## 1.2 Product Overview

FLEX 8 is a matrix capable to distribute any input signal to any output signal through its consistent modular capability to control up to 16 different inputs and 16 different outputs independently. Different devices can be connected in each output and input. It supports HDMI, DVI, SDI, USB and HDBaseT input and output signals, as well as DP output. FLEX 8 features in splitting mode for up to 2K1K, and simple managed by XPOSE software.

### System Connection

RGBlink video processing solutions provide a range of flexible configuration options for professional applications.

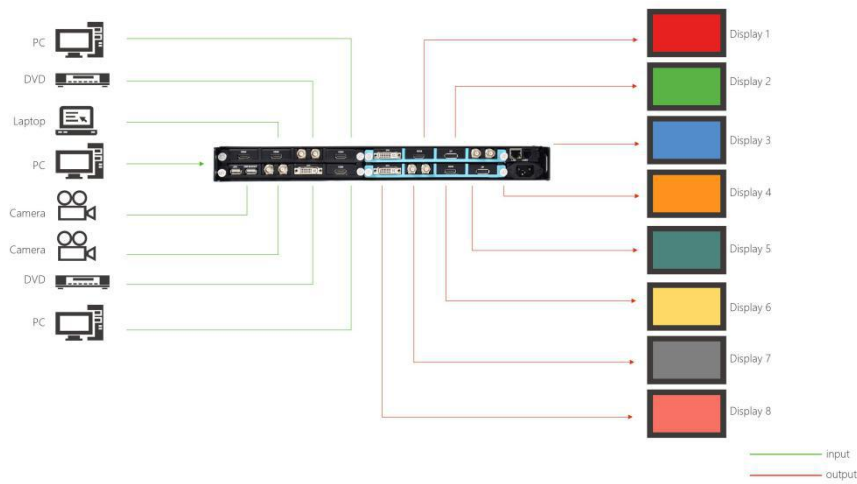



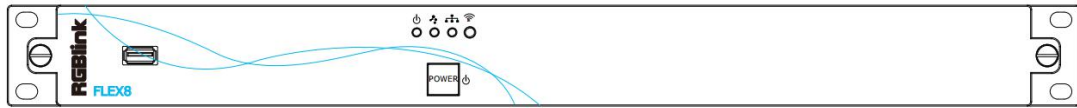

FLEX 8 System Connection Diagram

## 1.2.1 Basic Front Panel

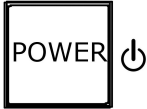

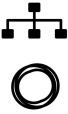
Basic front panel fit for FLEX with splicing feature ( with EXT4F-OS installed)







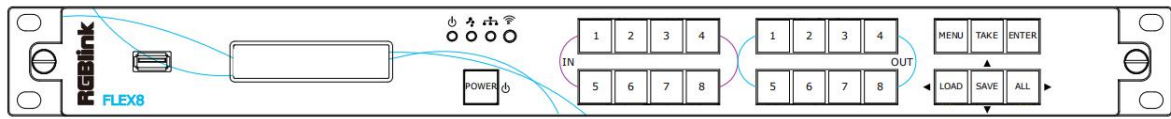



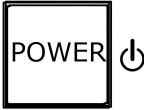

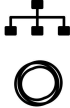
Panel Instruction			
	USB INTERFACE To upgrade the device		POWER BUTTON Turn on/off button. Indicator lights when the device is powered up or in standby state.
	Power Indicator Light up when device power on Keep lighting when device is working		Lan Indicator Lights up when LAN communication occurs
	Serial Port Indicator Lights up when serial communication occurs		Infrared Indicator



## 1.2.2 Matrix Front Panel

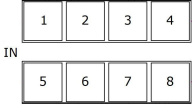
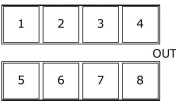

Matrix front panel fit for FLEX 8 with matrix feature (with EXT4F-OM installed)

Panel Instruction			
	USB INTERFACE To upgrade the device		POWER BUTTON Turn on/off button. Indicator lights when the device is powered up or in standby state.
	Power Indicator Light up when device power on Keep lighting when device is working		Lan Indicator Lights up when LAN communication occurs
	Serial Port Indicator Lights up when serial communication occurs		Infrared Indicator
	Menu Button		Take Button, to switch input signals with transition effects
	Button to confirm to enter Menu item		Load Button, to recall the preset from Saved pages
	Save Button, to save current settings to pages.		Choose all inputs or all outputs for matrix mode
	Input signal source selection button under matrix mode		Output signal selection button under matrix mode
	LCD display		

## 1.2.3 Back Panel

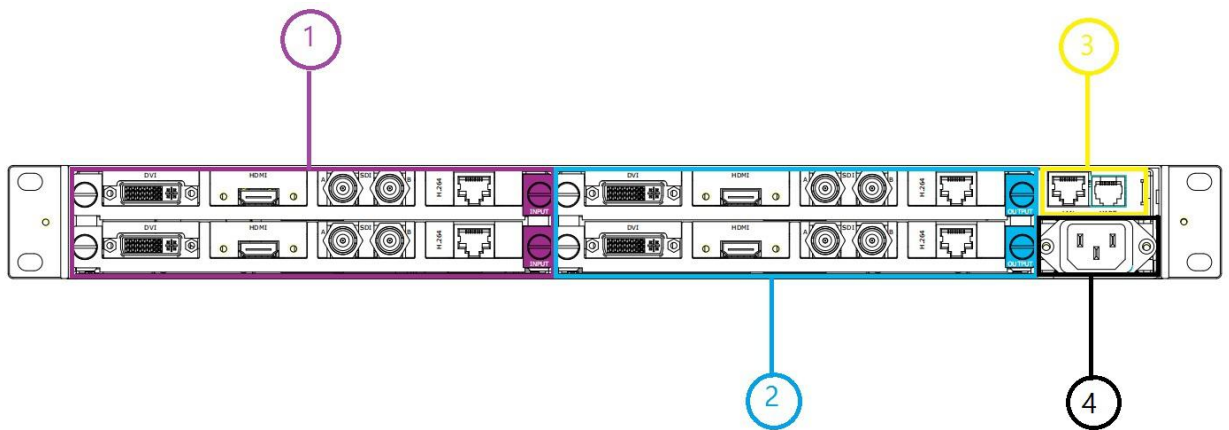

### Input Interface

1	<p><b>Input Card Slots</b> Supports input signals including HDMI, DVI, SDI, USB and HDBaseT.</p>
---	--

### Output Interface

2	<p><b>Output Card Slots</b> Supports output signals including HDMI, DVI, SDI, USB, HDBaseT and DP.</p>
---	--

### Control Interface

3	<p><b>Communication Ports</b> RS232&amp;LAN Connect to XPOSE software</p>
---	---

### Power Connection

4	<p><b>Power Socket-IEC</b></p>
---	--------------------------------

---

## 1.2.4 Dimension

Following is the dimension of FLEX 8 for your reference:

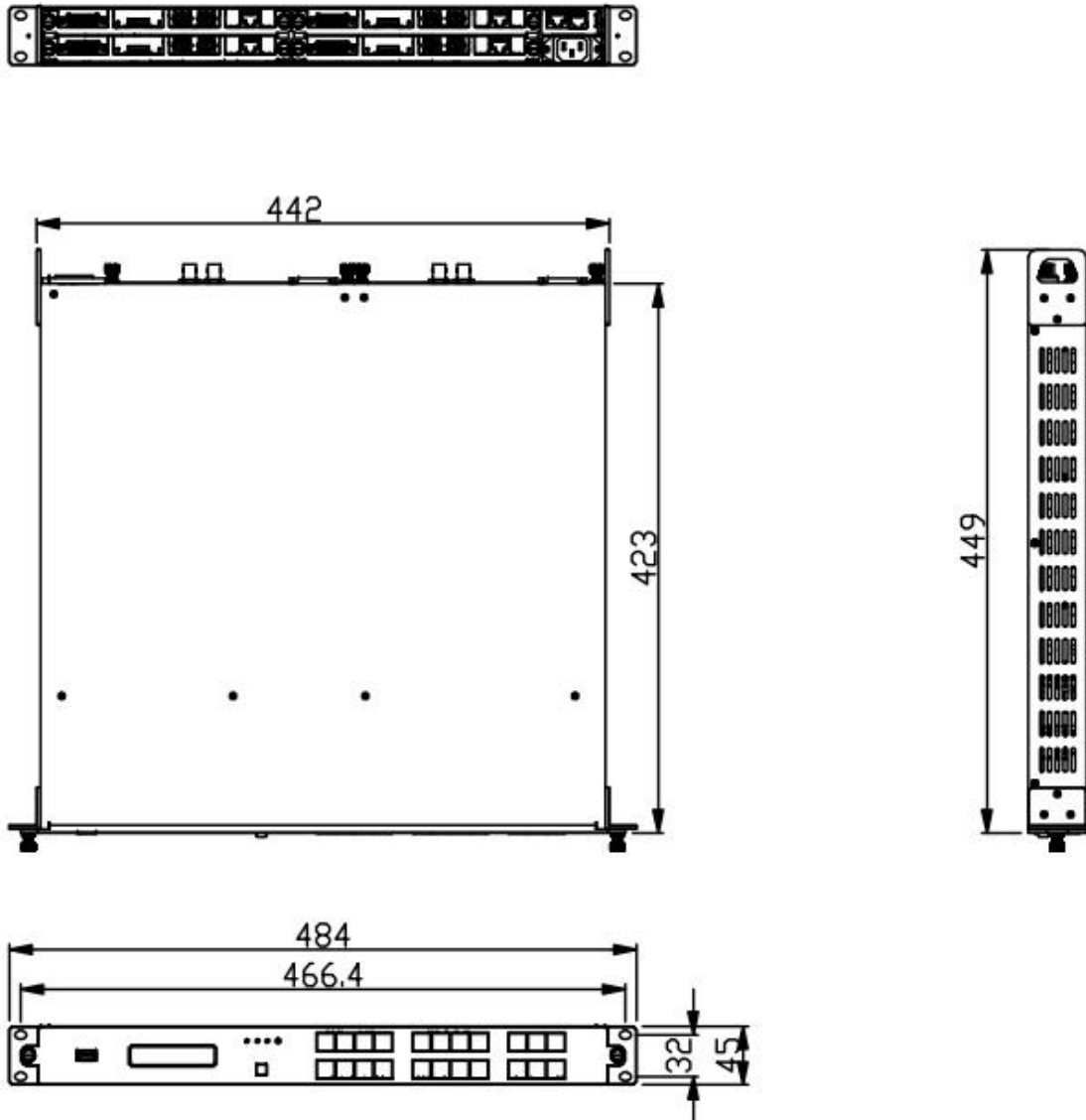

---

## Chapter 2 Install Your Product

---

### 2.1 Plug in Signals

Connect signals to the product (ensure all devices are powered off first). Tighten connector screws/locks where provided. Connect to XPOSE software by CAT5 cable. RGBlink provides a network cable for this connection, as a standard accessories. Please check in the package for this cable.

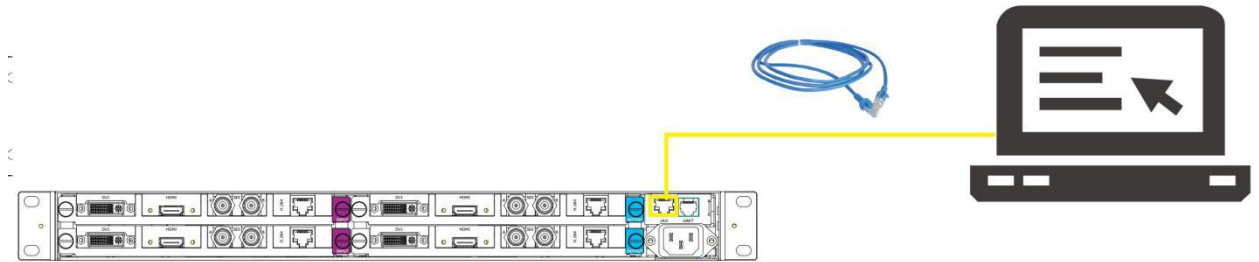

### 2.2 Plug in Main Power

Connect IEC cable to device and plug into wall socket. Turn on power at wall socket. The power indicator on front panel lights.

---

# Chapter 3 Use Your Product

---

## 3.1 Matrix Panel Operation

### 3.1.1 MENU Operation

#### Menu Structure

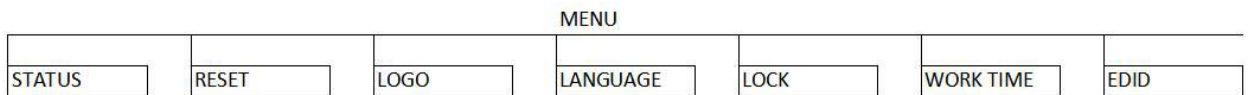



#### Basic Operation

Press MENU button  and enter the MENU item

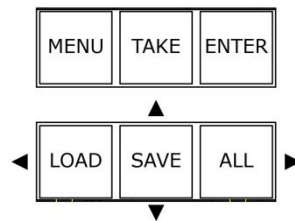

USE the buttons with arrows of up left right down direction to select.



3. Press ENTER  to enter the selected menu item.

#### STATUS

Shows : the status of each input to output and the LCD screen shows the exact info, as following example In→Out,



And the software version, serial number and IP address of the device.

---

## RESET

To go back to the beginning status, in the RESET item, LCD screens shows instruction as follow



PRESS ANY KEY  
PRESS MENU TO EXIT

## LOGO

Display logo ON/OFF



LOGO DISP  
→ON OFF

## LANGUAGE

To switch language between Chinese and English



LANGUAGE/语言  
→ENGLISH 中文

## LOCK

Lock front panel and make all buttons invalid. After panel is locked, MENU button flashes. The LCD shows info as follow:



FRONT PANEL LOCKED  
PRESS MENU 3S UNLOCK

After front panel is unlocked, MENU button light goes out.

## WORK TIME

Show the total boot times and working time up to now.



BOOT TIMES: 15  
TOTAL TIME:650MIN

---

### 3.1.2 Button Operation

#### Power Up

After the device is connect to power, it will automatically boot up. After the device is powered up LCD shows the following:

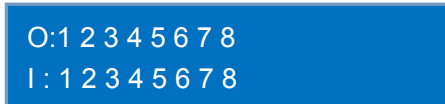

#### Select output

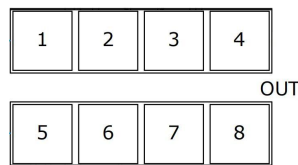

Press any button among 1-8 in OUT area, the corresponding output can be selected and the button light illuminates.

#### Select input

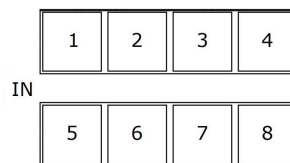

After the output is selected, press the button among 1-8 in IN area and the button flashes. The corresponding input is taken to the output immediately.

#### Select ALL output



Press button ALL and all buttons in OUT area light up, then press any button in IN area, all outputs display the one selected input. For example, after pressing button ALL and press button 6 in IN area, all the displays shows the image of input 6. The LCD on device shows the info below:

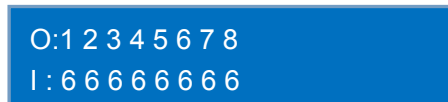

Press button ALL again, all lights go out except button 1 in OUT.



If the IN→OUT (matrix) setting need to be saved, press button SAVE , LCD will show

---

instruction as below

SAVE TO: \_

At this time, press any button among 1-8 in IN area, it means save to the corresponding position of 1-8, i.e., press button 2 means save to SAVE 2.

Press any button among 1-8 in OUT area, it means save to corresponding position of 9-16, i.e., press button 1 means save to SAVE9, button 7 means SAVE15.

LOAD

### LOAD

If the saved setting need to be recalled,press button LOAD, LCD will show as below

LOAD FROM: \_

The button indicating saved position illuminates and the latest saved position flashes. For example, in previous operation, there are 3 saved position, SAVE2, SAVE9, SAVE15, SAVE15 is the latest one, button 2 in IN area, button 1 in OUT area illuminate and button 7 in OUT area flashes.

Press the above illuminating or flashing button to Load the corresponding SAVE.

POWER ⏻

### POWER-STAND BY MODE

Press button POWER LCD shows the indication as follow:

ENTER STANDBY MODE  
YES<ENTER>,NO<MENU>

In stand by mode, press POWER for 3S, all buttons flashes one by one immediately and LCD shows

RGBLINK  
FLEX 8

5S later, the device goes back to work and in the status before stand by.



---

## 3.2 XPOSE Control FLEX 8

### 3.2.1 Install Software

#### Minimum Requirements

##### Windows

Operation System	Windows 7/8/10
Processor	1GHz/32 bit or 64 bit processor
Memory	2Gb
Hard Disk	16Gb
Graphics	128Mb/DirectX9
Display	1280X720

##### Mac

Operation System	Mac OS
Processor	1.0GHz+
Memory	512M+
Hard Disk	512M+
Graphics	512M+
Display	1366x768

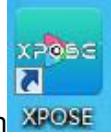

1. Double click icon , it will pop-up the Installer Language box, select the language, for example, select “English”, and click “OK” to confirm.



It will pop-up the installer box, and click “Next” to install, as follows:



2. Select “Browse...” to select the XPOSE software install location and click install:

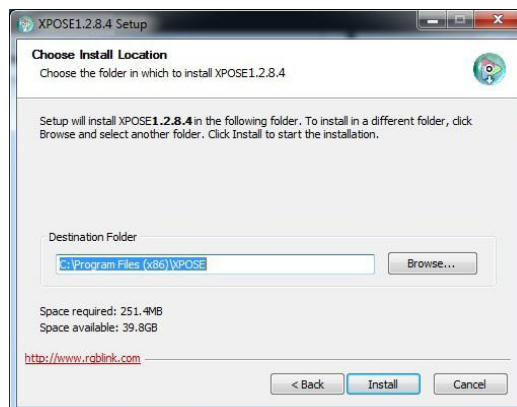

3. User should get the rights in “Roles Management” when install the software to disk C if the system is Windows 7 or above.

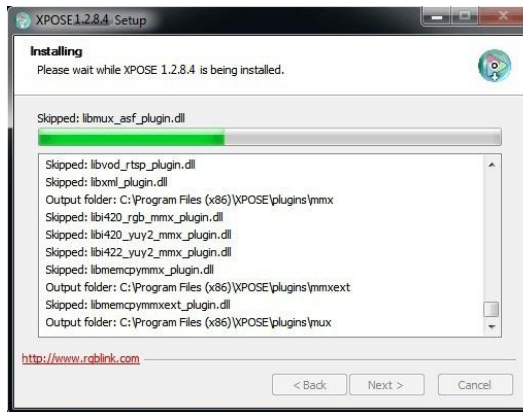

4. Click “Finish” and is ready to run the XPOSE management software:



---

### 3.2.3 Login to the Software



1. Double click the icon XPOSE on the desktop, then login into the interface. The user name is Admin, and defaultly there is no password. Select “FLEX 16”, select language “English” and enter the software by clicking “Login”.

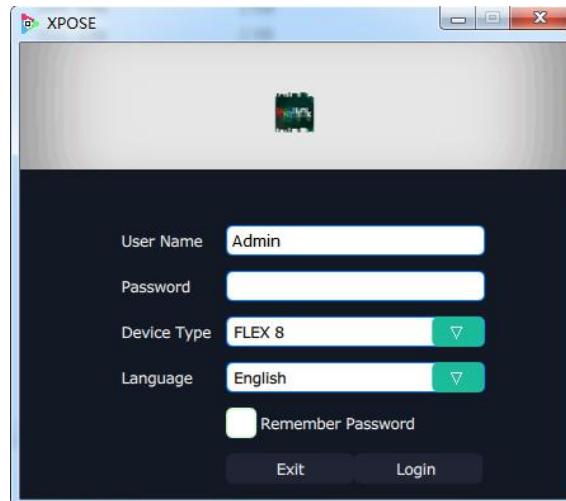

2. If user wants to change the language to Chinese, click the drop down arrow after “Language” and select “中文”, then click “Login” to enter the software.



3. After entering the software, the main interface shows as follows:

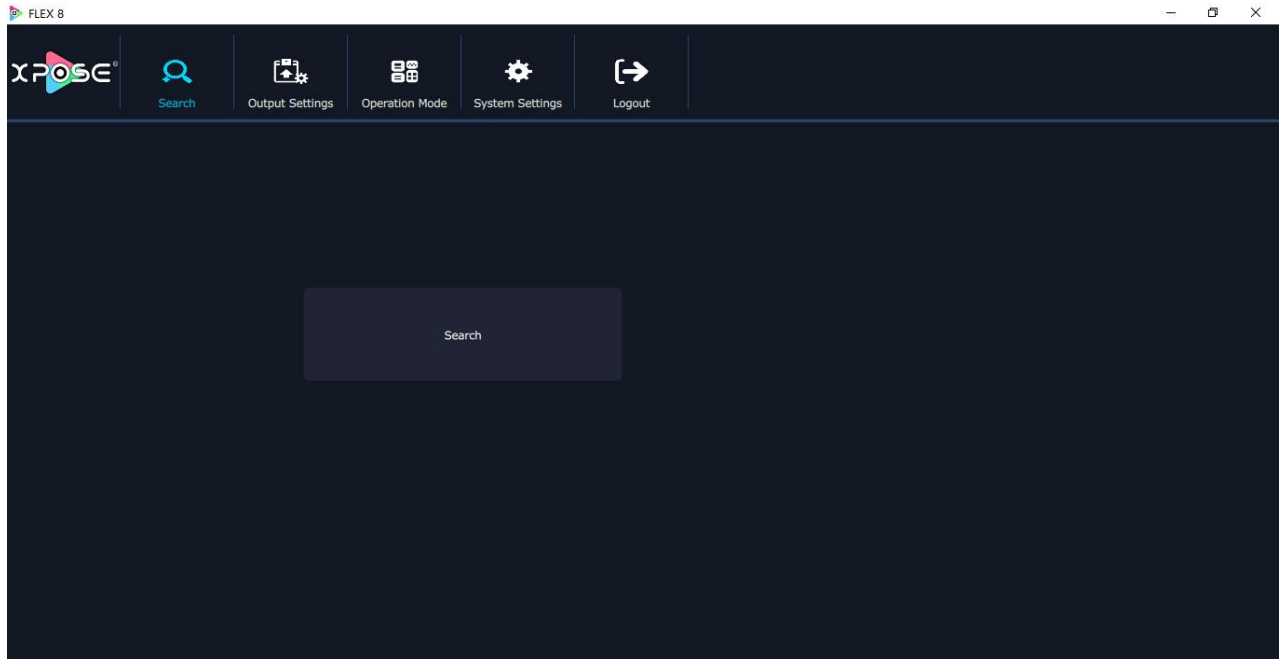

XPOSE management software consists of Output Setting, Operation Mode, System Settings and Log out. In the following parts come with the detail.

### 3.2.4 Connect to Software

Connect the remote controller PC which runs XPOSE to Flex 8 by the network cable In

The Box. Click search  to find the device as follows:



and get the device to XPOSE

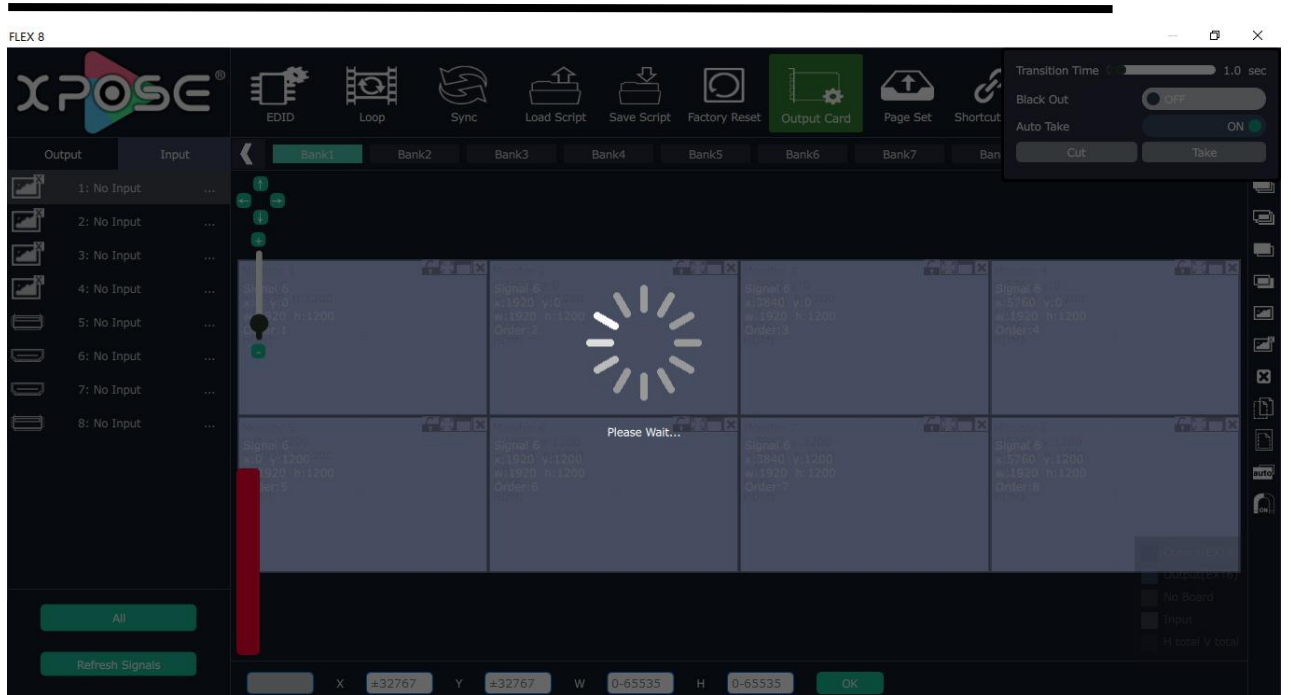

After Sync, enter the following interface.

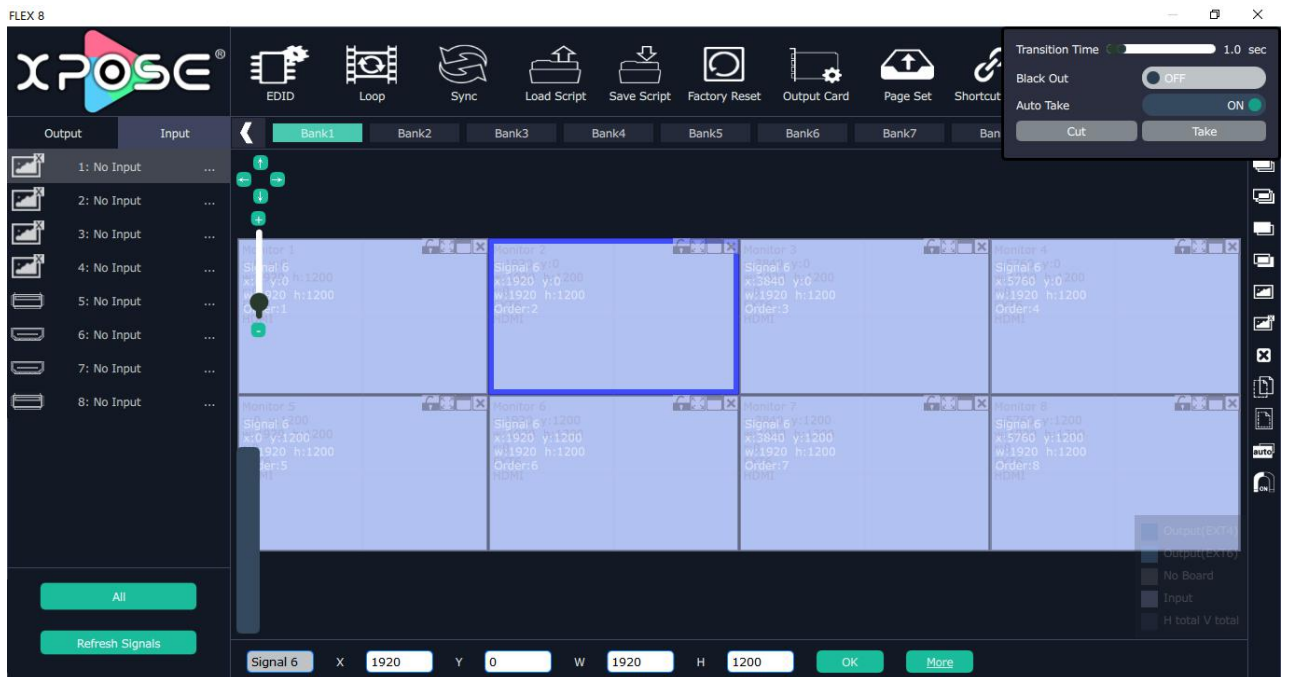

Close the current interface, just click the X    on the right top corner and enter the main menu interface.

---

### 3.2.5 Output Setting



Click Output setting  and enter the interface as below:

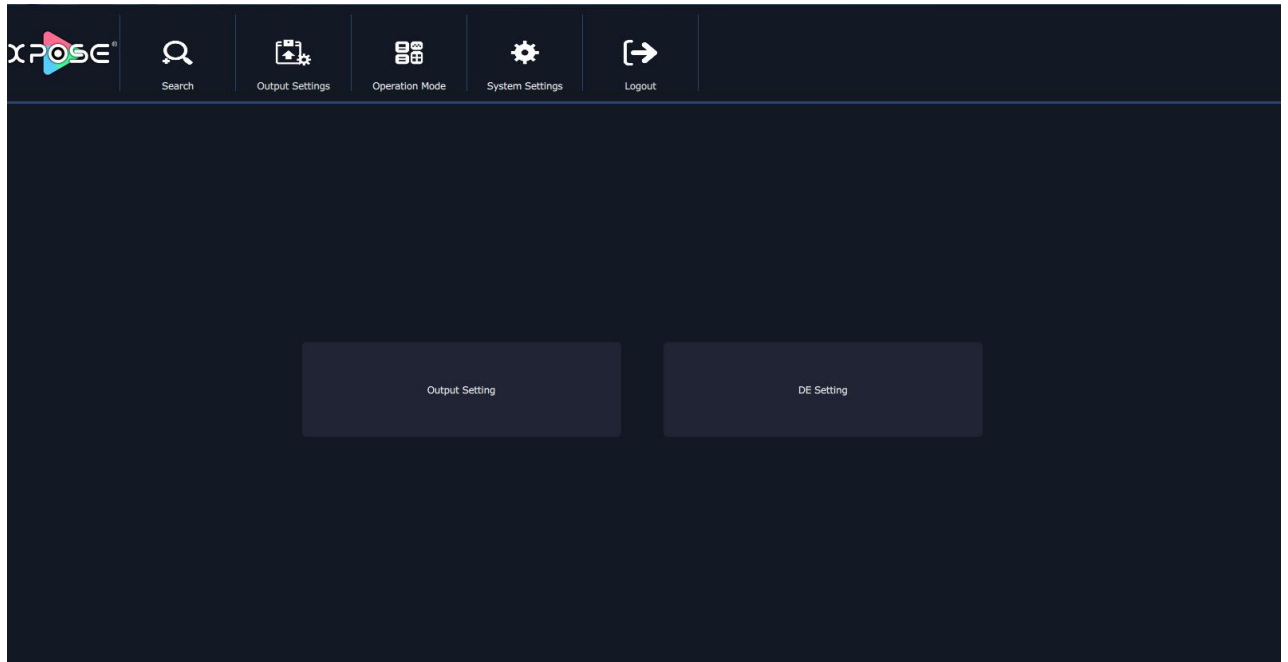

---

## Output setting

choose output resolution here

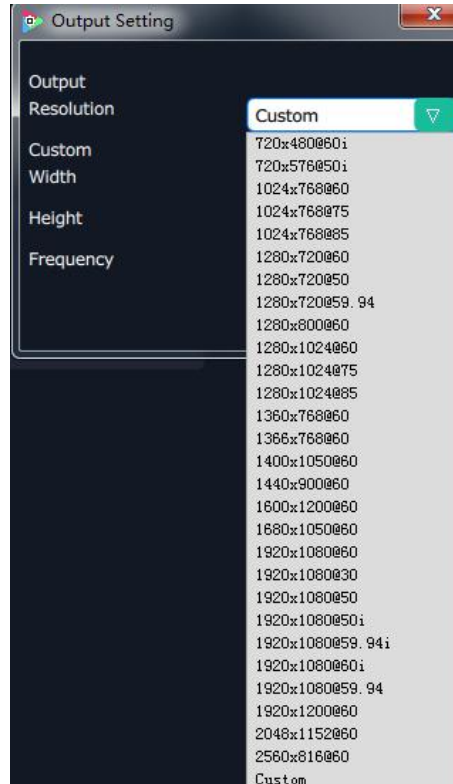

There are 28 standard resolution format available and users can chose custom the output resolution by choose "Custom " and type in the Custom Width. Height and Frequency.

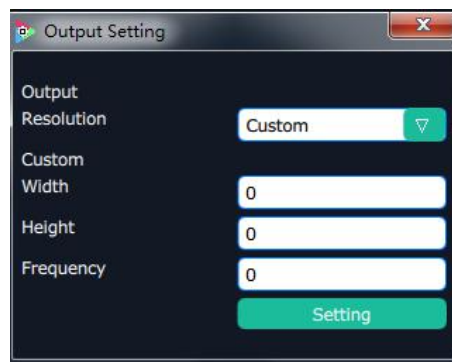

User can custom the resolution if no proper resolution in the list,

Note: avoid using following resolution

720×480i@60Hz and 720×576i@50Hz (not supported on all output modules, except via adapter through DVI module connected to EXT 4F-OM matrix output ext interface ),

2560×816@60Hz and 2048×1152@60Hz (not supported on DVI and HDMI output) .



---

Then click Setting  to confirm.

## DE Setting

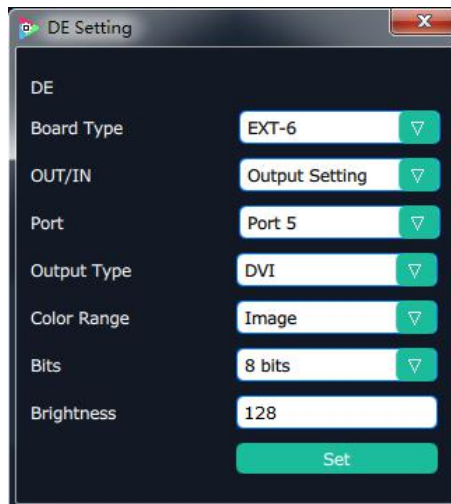

Board Type: select EXT-6 (EXT4F-OS) or EXT-4 (EXT4F-OM) based on the real installation of the device.

Out/In: Output setting or Input setting

Port:Port1-Port 8 to choose

Output Type:DVI or HDMI

Color Range:Image or Video

Bits:8bit

Brightness:0-128

---

## 3.2.6 Operation Mode

There are 2 working modes, including the Matrix mode and Splitting Mode. Click the “Operation Mode”, and enter the interface as follows:

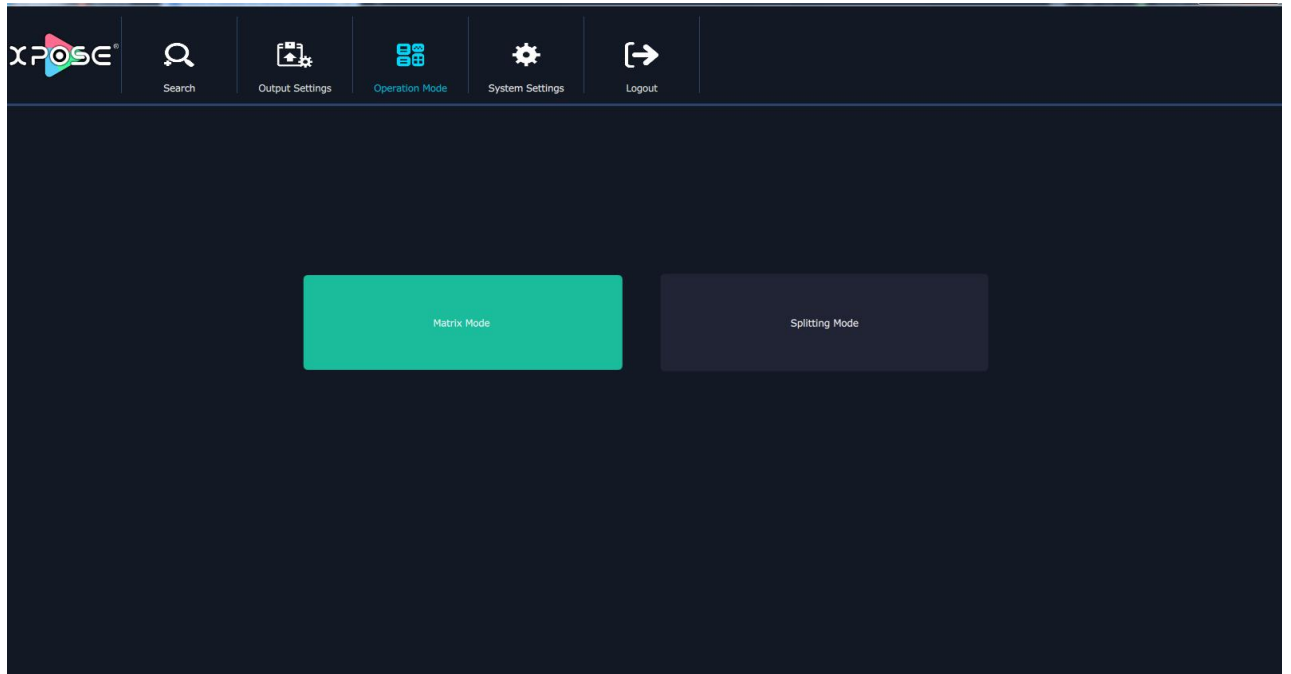

Matrix Mode and Splitting Mode are included in operation mode, specific as follows:

### Matrix Mode

Click the “Matrix Mode”, and enter to the interface as follows:

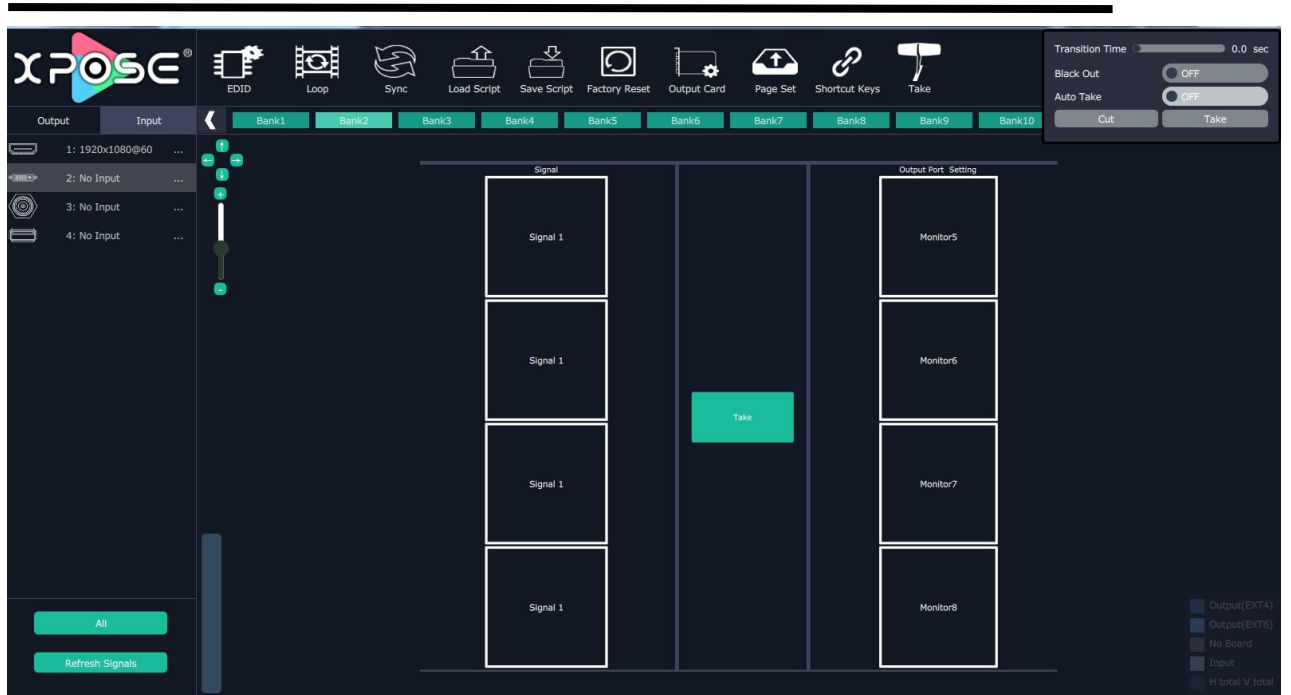

In→Out

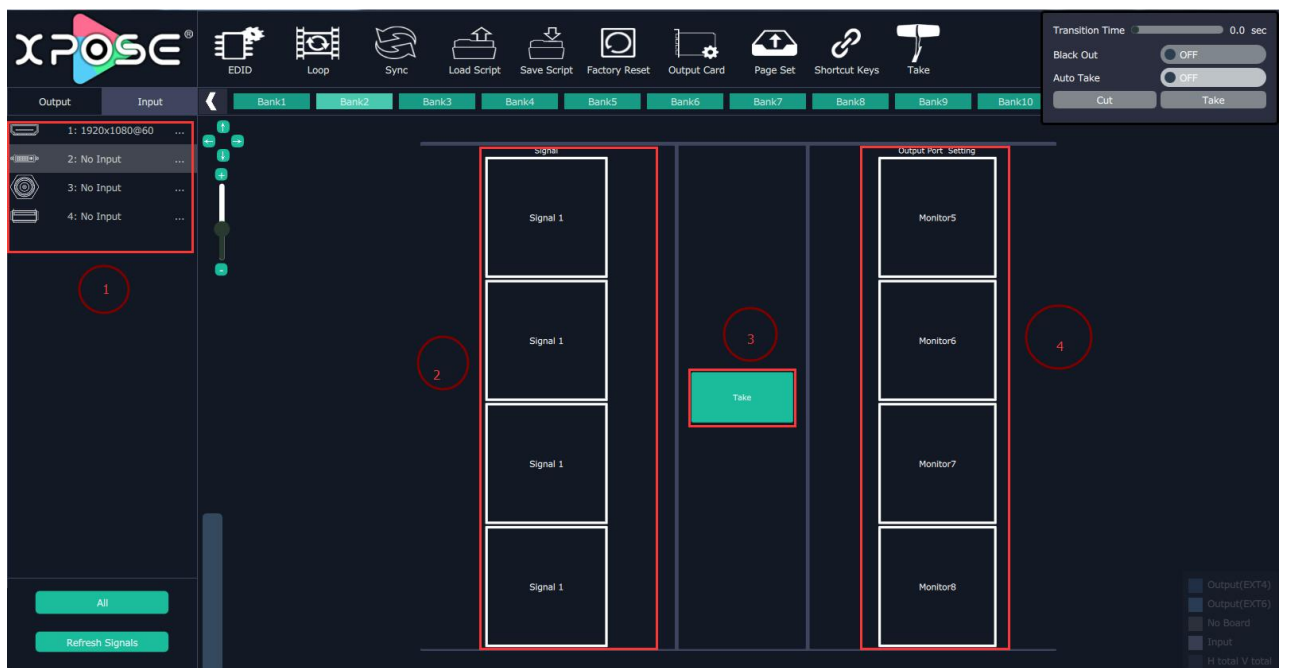

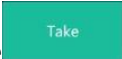
1. Choose input source from the signal source list
2. Drag the signal source to Signal
3. Click Take 
4. The display will show the input source correspondingly as the following show:

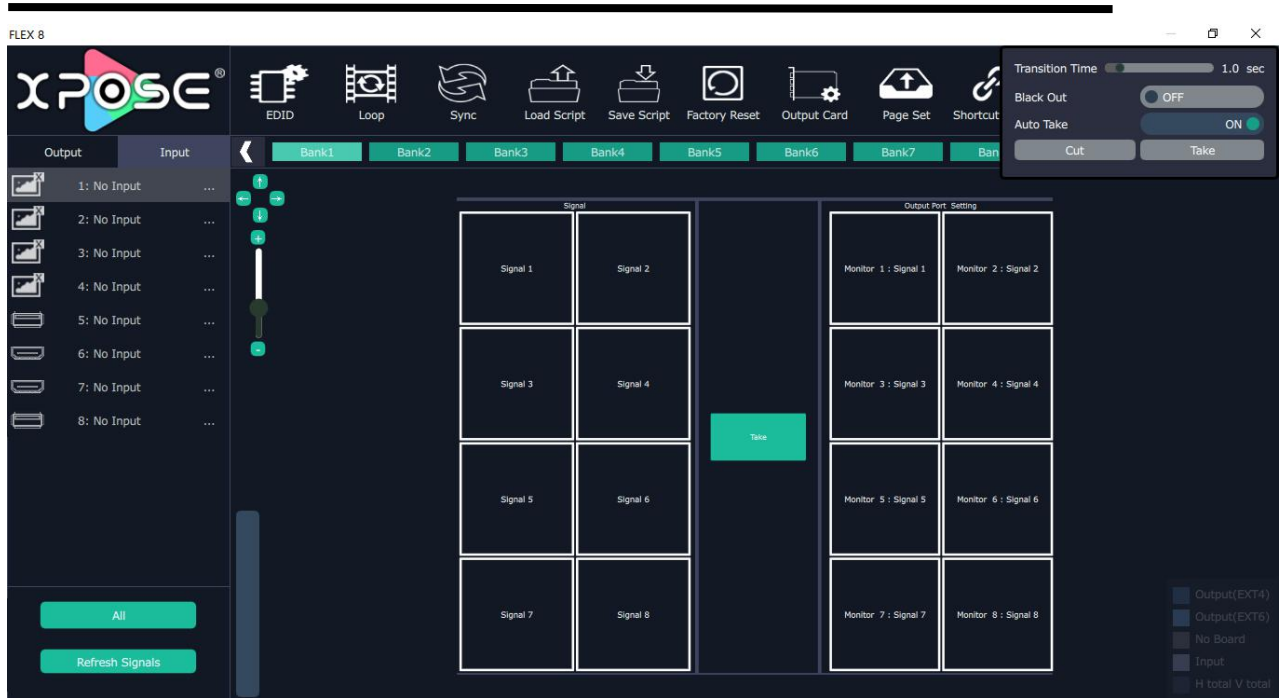

For FLEX 8 with matrix front panel, users can use XPOSE or front panel panel to control the device.

For FLEX 8 with basic front panel, users can only use XPOSE to control.

### 1 IN-All Out

Choose one input source from the signal source list

Click All 

Click Take 

All display will show the one chosen input source as the following show:

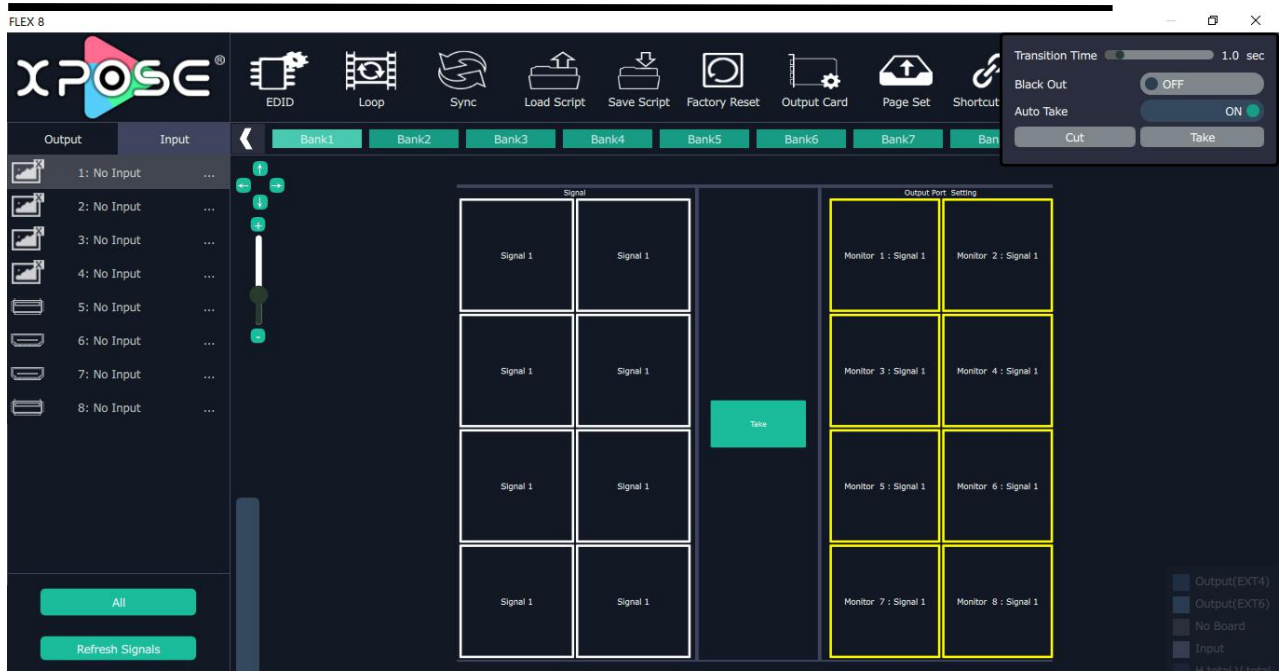

## Output Card

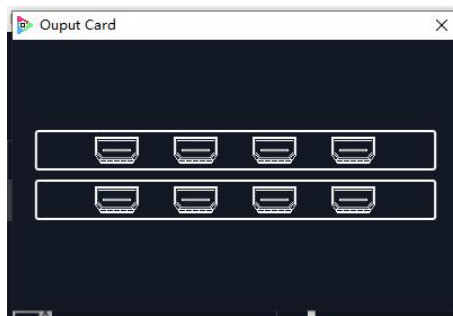

Click each output port, users can set output resolution of each port

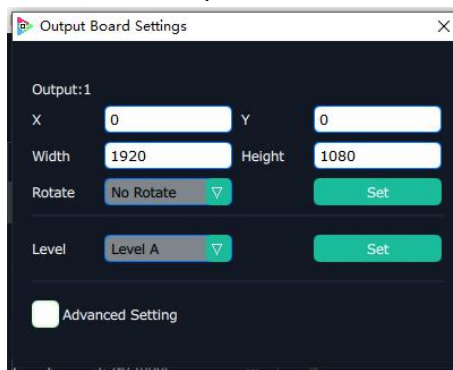

Choose Advance, scale and crop setting can be done.

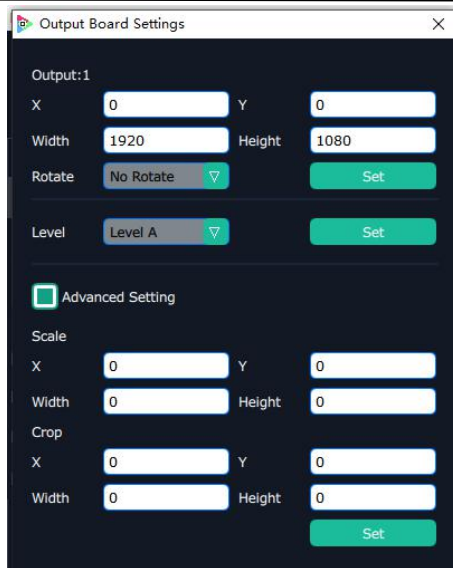

## Splitting Mode

Click the “Splitting Mode”, and pop-up window as follow:

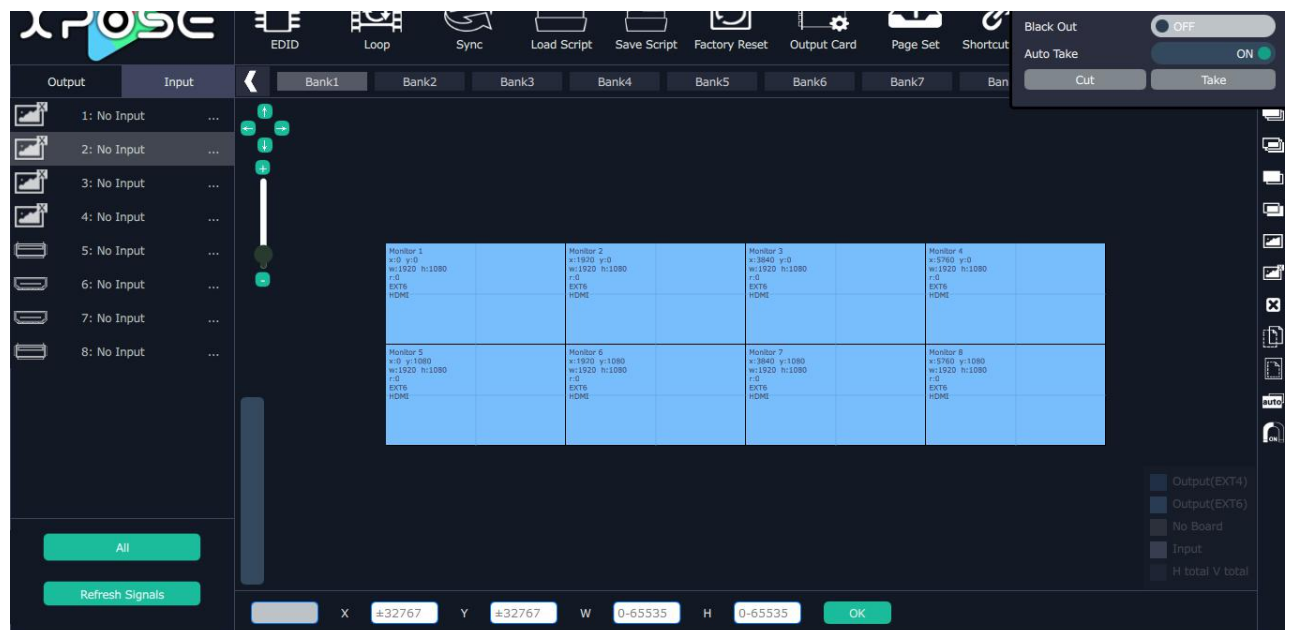

To do quick splitting, users can choose signal from signal list and drag it to the window. Drag the border of the layer to cover all the monitors.

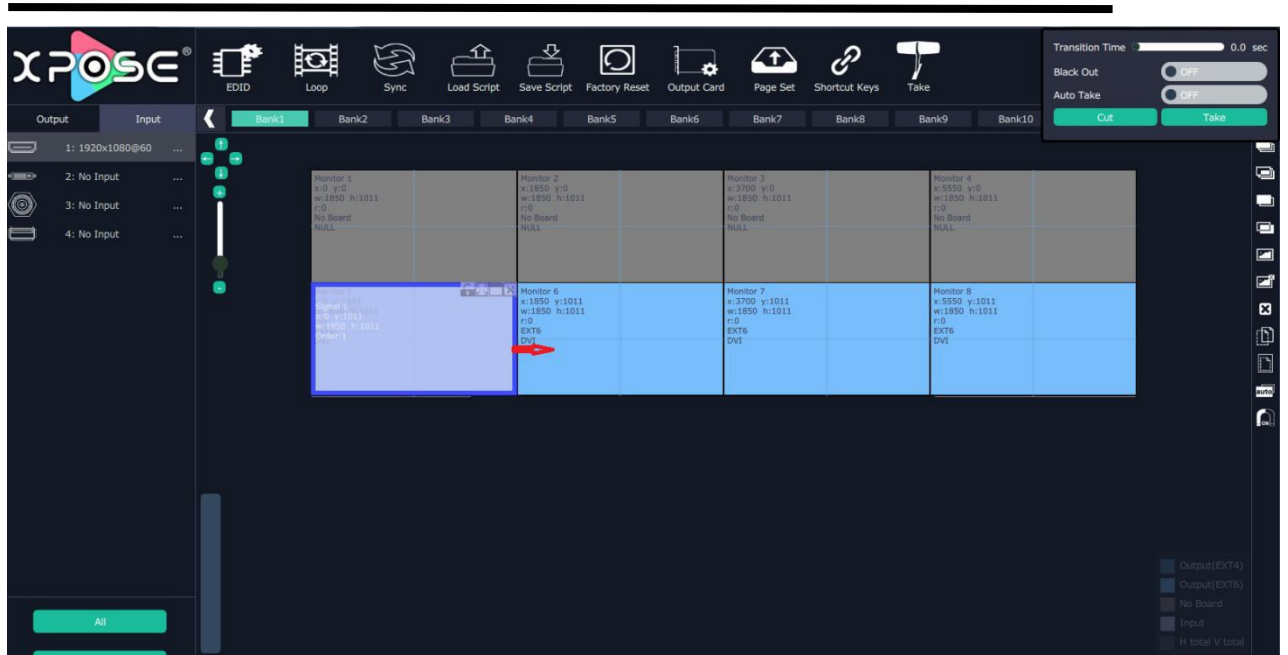

For example, do splitting on 4 monitors, after setting the resolution of each output, drag the input source to the output window and cover up all outputs. To make sure the signal cover up all outputs more exactly, users can type in the total width and height of the desired video wall size.

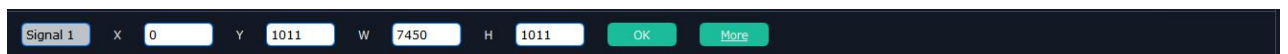

## Input Setting

The signal list is shown as follows:

Output	Input
1: 64x64@0	...
2: No Input	...
3: No Input	...
4: No Input	...
5: No Input	...
6: No Input	...
7: No Input	...
8: No Input	...

It displays the input module type, the quantity of inputs and input format. Click "... after the format of input for the following settings:

For HDMI and SDI input there are settings as below:



**Change Name:** Select “New Name”, and input the new name, click “OK” after setting.



**Set Input Property:** Right click the input and select “Input Property”, it will enter to the interface as follows:

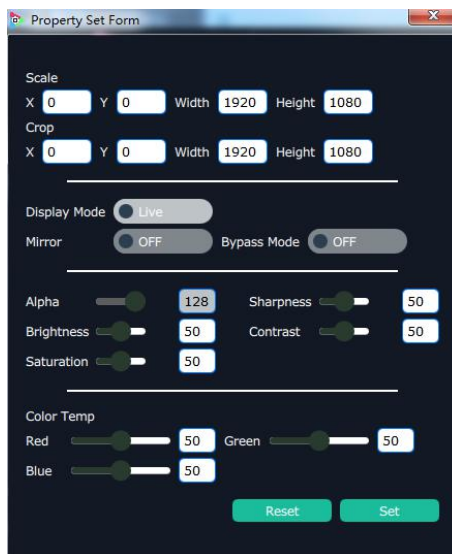

**Scale:** Set the X, Y, width and height.

**Crop:** Crop the left, top, width and height.

**Display Mode:** Select “Live” or “Freeze”.



- 
- Mirror:** Enable or disable the mirror function, default “OFF”.
  - Bypass Mode:** Enable or disable the bypass mode. When select “ON”, the output **format** will be the same with the input format.
  - Alpha:** Set the alpha, the adjustment range is 0~128.
  - Sharpness:** Set the sharpness, the adjustment range is 0~100.
  - Brightness:** Set the brightness, the adjustment range is 0~100.
  - Contrast:** Set the contrast, the adjustment range is 0~100.
  - Saturation:** Set the saturation, the adjustment range is 0~100.
  - Color Term:** Set the color temp (red, green and blue), the adjustment range is 0~100.
  - Reset:** Select “Reset”, the input property will be recover to factory setting.
  - Test Pattern:** Slide the Test Pattern switch to enable or disable the function.

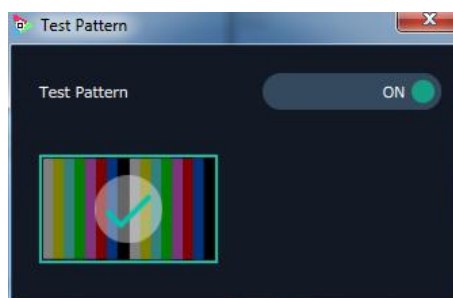

For USB input setting there is USB player setting



select “USB Player”, it will enter to the USB Player interface, including movie and picture, default play the USB picture.

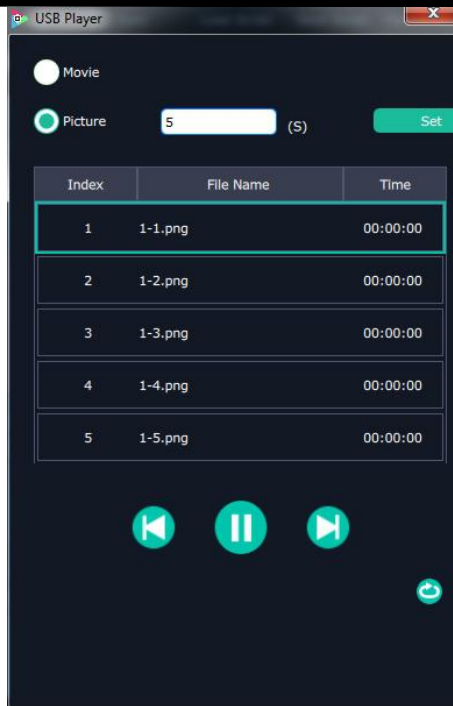

**USB movie player setting:** Can select play in order, random, single cycle and all cycle, switch to pre or next, pause or play, and read the movie name, progress bar and time.

USB picture play time: Click the picture, it will display the setting interface, default the time is 0s. Set the switch time, and click "Set".

**USB picture player setting:** Can select play in order, random, single cycle and all cycle, and switch to pre or next, pause or play.

DVI module of FLEX 8 is compatible with VGA, CVBS, YPbPr signals via adapter , therefore for other signal such as VGA input, users need to choose VGA in DVI input setting as below:

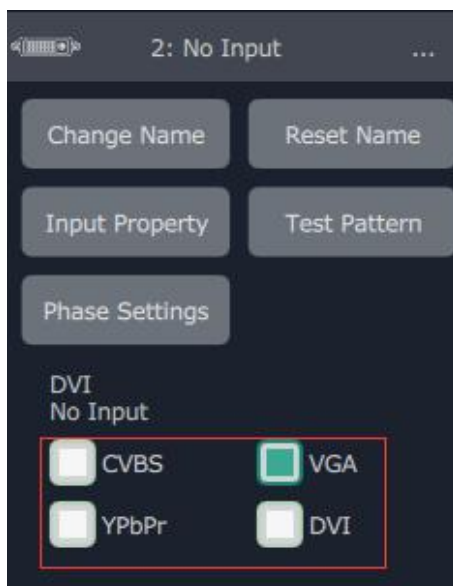

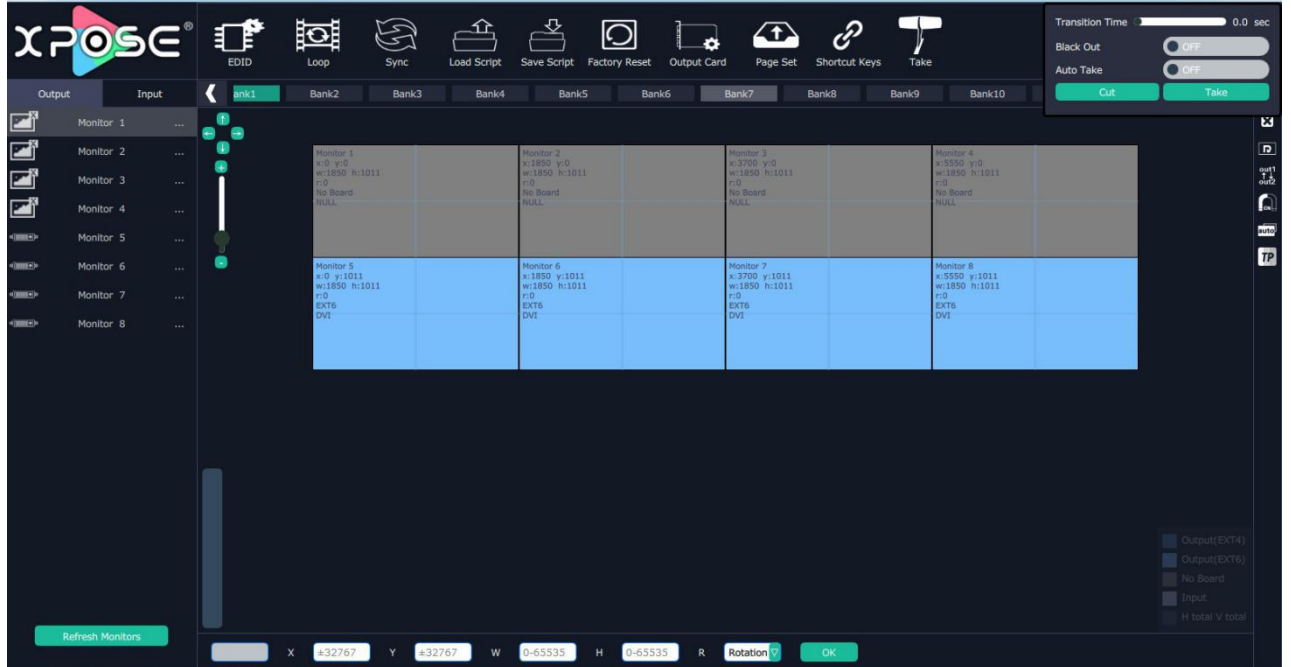

## Output Setting

Click on shortcut , it will enter the interface as follows:



**Close monitor:** Click the icon  on the top right corner of the monitor to close

one monitor, or click the shortcut  on the right side of the interface to close all monitors.

**Reset outputs:** User can reset outputs by clicking the shortcut  on the right side of the interface.

**Swap outputs:** User can swap outputs by clicking the shortcut  on the right side of the interface, as shown in the figure below.

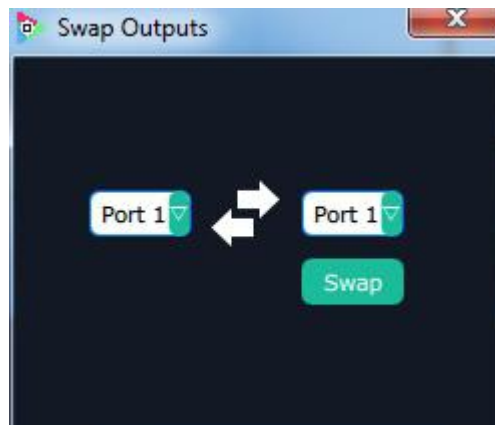

## Swap port1 and port4

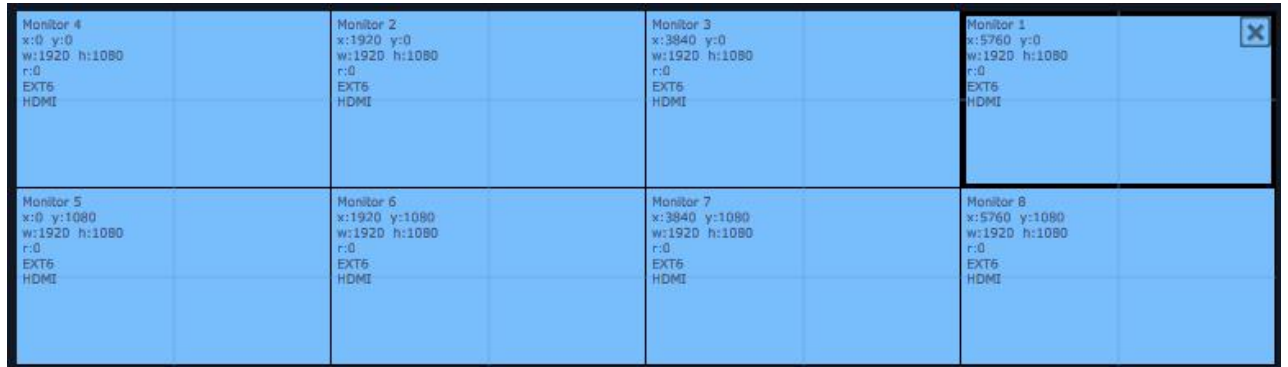

**Auto tile:** User can enable or disable the auto tile function by clicking the auto tile



shortcut on the right side of the interface. If select auto tile “ON”, the layer will automatically snap to the output grid when move the layer to the position within the threshold value.

**Monitor Size and Position Setting:** Move the mouse to the lower right brink of the monitor, and press the left key of the mouse. Move the mouse to the suitable position and release the mouse. But this method can only adjust the size and location roughly, if an accurate adjustment is needed, select the monitor, and set the X, Y, width and height in the bottom of the interface.



**Monitor Size changed equivalently:** Select any monitor, for example, select monitor 1, and adjust the size. Click this monitor, then press button C and don't let go, select the monitor that will set, the size of the selected monitor will be changed to the same size of monitor 1, as shown in the figure below:

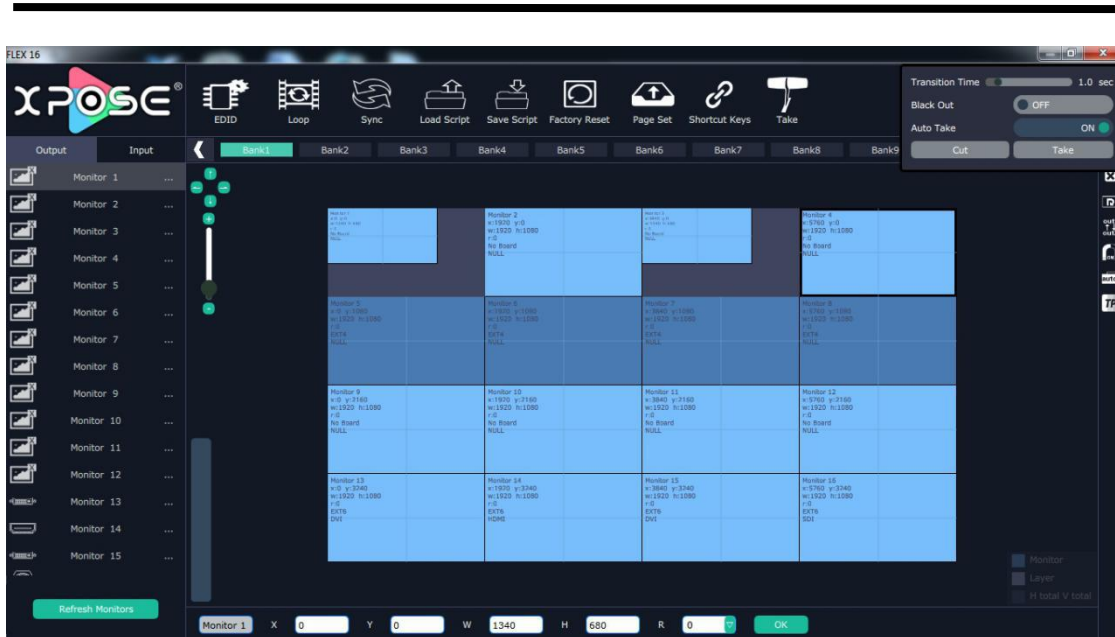

**Rotation:** Select the monitor, and set the rotation as 0°, 90°, 180° and 270° in the bottom of the interface. Click “OK” to confirm. As shown in the figure below:



Note: select any 1 out of the 4 outputs which are connected to the same EXT extension interface.

Right click the monitor can also rotate the monitor.

**Adjust Output Area :** Move the mouse to the output area and slide the mouse wheel, the output area size can be zoom in and out. There are three other ways to adjust the position and size of the output area.

1. Auto Adaptive
2. Adjust the proportion of output area on the interface window automatically.
3. Up Down Left Right Arrow to move the position
4. + - to adjust the size

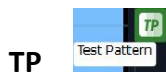
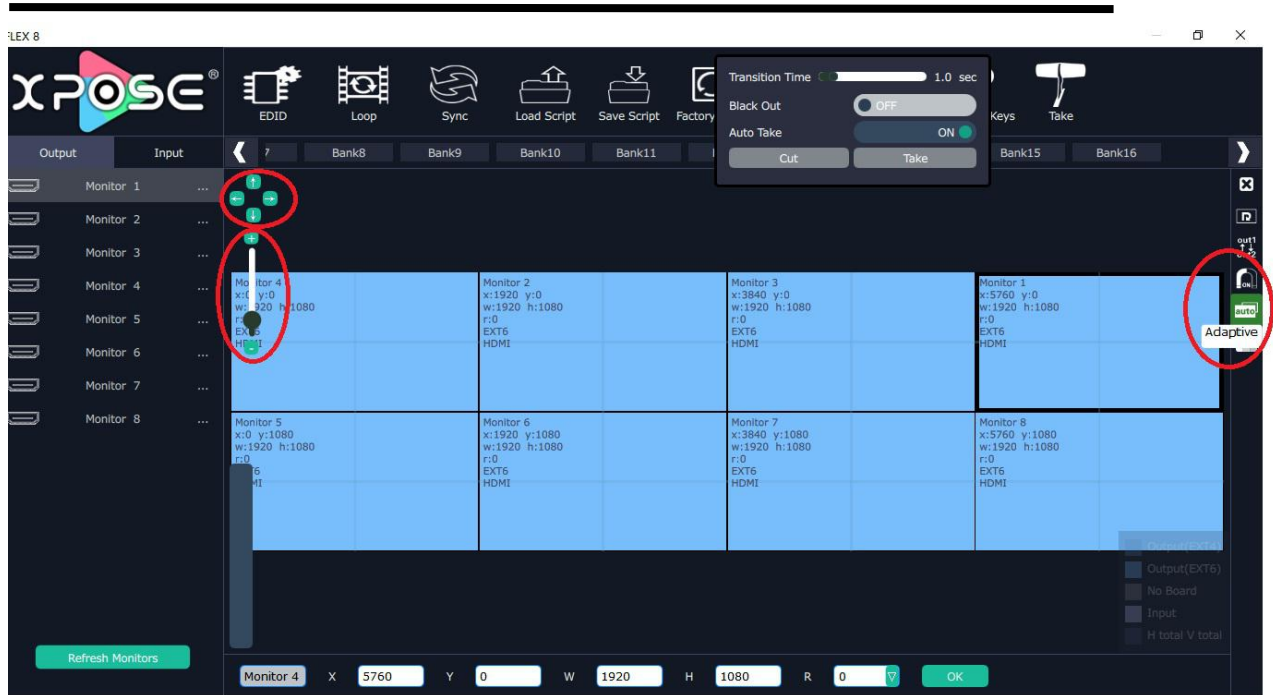

TP

Choose

Board 1-4

Color Choose: Signal Souce, Color Bar, Pure Color

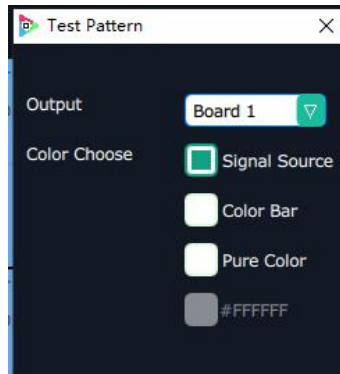

Set TP OK

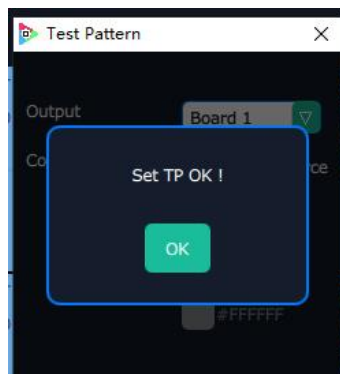

---







**Adjust Layer:** Two ways can change the size and location of the opened layer:



a. Drag the opened layer by mouse. The details are: move the mouse to the brink of the opened layer, when the mouse shows “<—>”, press the left key of the mouse and drag the window to a suitable size and then release the mouse. Or move the mouse to the lower right of the opened layer, press the left key of the mouse and drag the window to a suitable size and then release the mouse. Move the mouse to the opened layer and press the left key of the mouse and move the mouse, then the layer will be moved, release the mouse when moved to the suitable location. But this method can only adjust the size and location roughly, if an accurate adjustment is needed, the second method can be used.

b. Select the layer to be adjusted, and set the X, Y, width and height in the bottom of the interface.





**Hierarchical relations between layers:** After creating the layers, the hierarchical relations can be changed by the following: click the shortcut key bring layer to front



“”, send layer to bottom “”, layer forward “” or layer backward “”. The layer can be set as background by click “” and click “” to close layer background.

**Close one layer or all layers:** Click the icon  on the top right corner of the layer to close one layer, or click the shortcut key “” to close all layers.

**Lock the layer:** Click the icon  on the top right corner of the layer to lock the layer, the layer can't be moved or adjusted if be locked.

**Full the layer:** Click the icon  on the top right corner of the layer to full cell, and click the icon  to full screen.

**Copy and paste bank:** Select the bank that to copy, and click the copy bank shortcut

“” on the right side of the interface, then select the bank that to paste, and click the paste bank shortcut “”. The selected layer will pasted to the bank.

**Adaptive:** If scale the output area to a large area, click the adaptive shortcut “” on the right side of the interface, the output area will be return to the best position.

## Layer Property Setting

Select the layer to be adjusted, click the More shortcut “[More](#)” in the bottom of the interface, and enter the interface as follows:



Scale: Set the X, Y, width and height.

Crop: Crop the left, top, width and height.

Display Mode: Select “Live” or “Freeze”.

Mirror: Enable or disable the mirror function, default “OFF”.

Bypass Mode: Enable or disable the bypass mode. When select “ON”, the output format will be the same with the input format.

Alpha: Set the alpha, the adjustment range is 0~128.

Sharpness: Set the sharpness, the adjustment range is 0~100.

Brightness: Set the brightness, the adjustment range is 0~100.

Contrast: Set the contrast, the adjustment range is 0~100.

Saturation: Set the saturation, the adjustment range is 0~100.

Color Term: Set the color temp (red, green and blue), the adjustment range is 0~100.

Reset: Select “Reset”, the input property will be recover to factory setting.

## Take

The take interface is shown as the figure below:

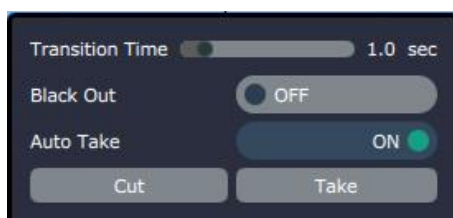

Set the transition time, and the adjustment range is 0~10S.

Slide the black out switch to enable or disable the black function. Auto take on is the



---

default state. If select black out and auto take on, the preview image will black or seamless switch to LED display instantaneously.  
Click “Cut” or “Take”, the preview will be cut or seamless switch to LED display.

## EDID



Click the EDID shortcut “”, and pop-up window with input ports that support EDID as follows:



The special display project or LED display application would like to require special resolution settings to meet the requirement. Select the suitable input port to customize the EDID. As shown in the figure below:

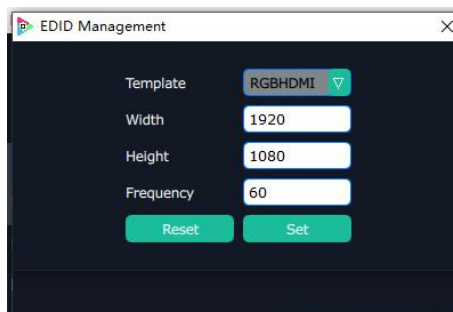

## Loop



Click the loop shortcut “”, and pop-up window as follows:

### Timing Loop

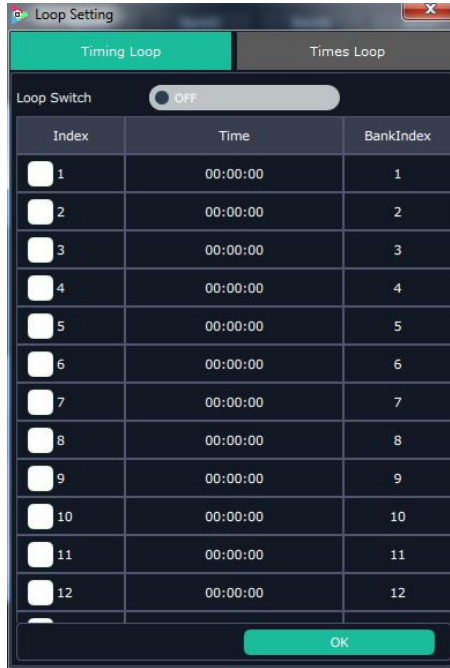

Slide the loop switch to enable or disable the timing loop function for the bank. If select “ON”, the exact time to play the bank can be set.

**Times Loop**

Slide the loop switch to enable or disable the times loop function for the bank. If select “ON”, the exact length of time to play the bank can be set.



---

## Sync



Click the sync shortcut “ Sync ” to synchronize the current data.

## Load Script



Click the load script shortcut “ Load Script ”, user can load the data from the computer.

## Save Script



Click the save script shortcut “ Save Script ”, user can save the current data to local computer (Save Script) or chose Offline Saved to save saved bank to local computer Offline Saved as follows:

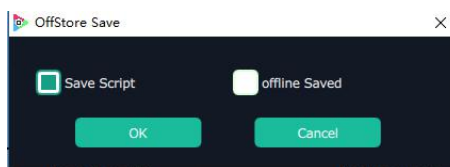

## Offline Saved

Choose offline saved, it will pop window with saved banks.

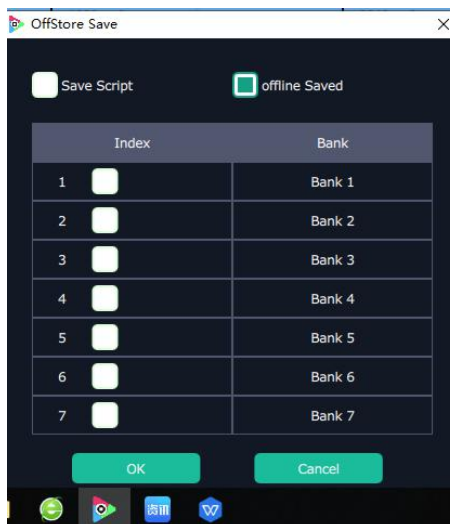

Choose the bank to be save and click OK, bank will be saved to local computer.

## Factory Reset



Click the factory reset shortcut “Factory Reset” to reset to factory settings.

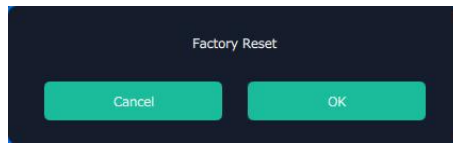

Factory reset is to go back to the factory initial setting of each IN-OUT.

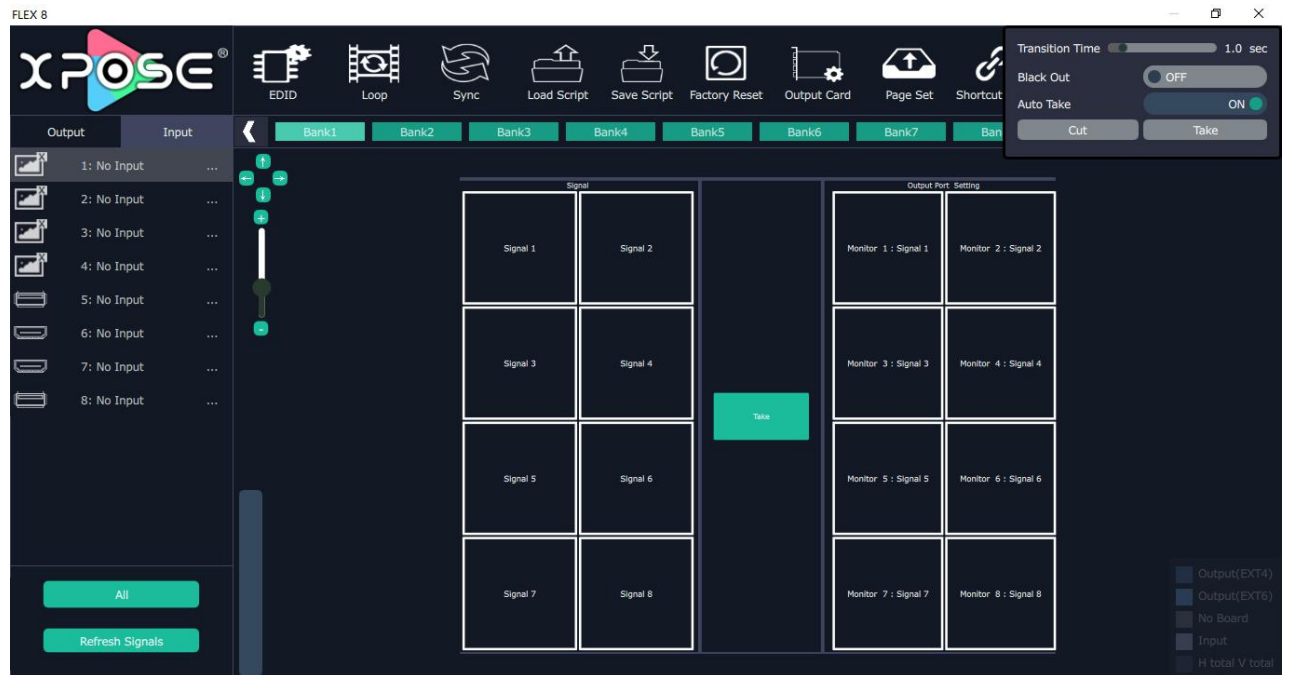

## Page Set



Click the page set shortcut “Page Set” to load and save pages.

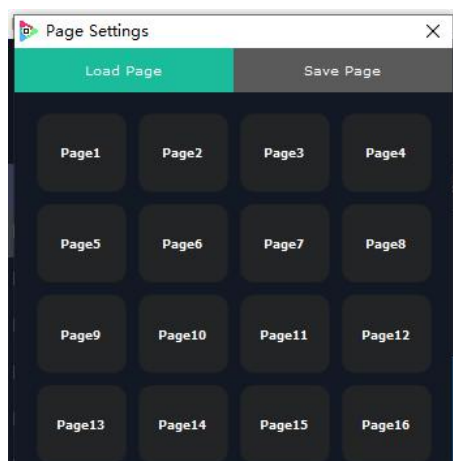

## Save Page

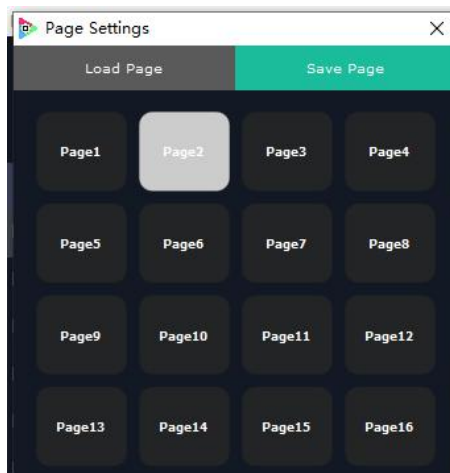

Grey page indicate this page has been used, a setting has been saved in this page.

## Load Page

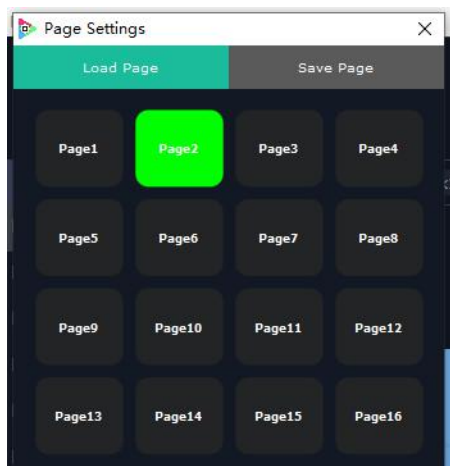

Green page indicated that there is a saved available to load.

## Shortcut Keys



Click the shortcut “”, and pop-up window as follows:

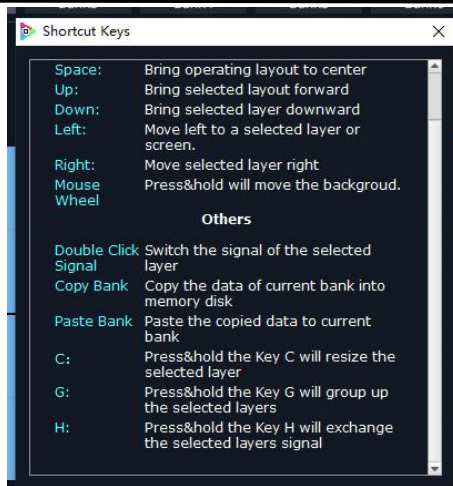

Use shortcut key to operate fast and easily.

---

## 3.2.7 System Settings

Click “System Settings” in the main interface:

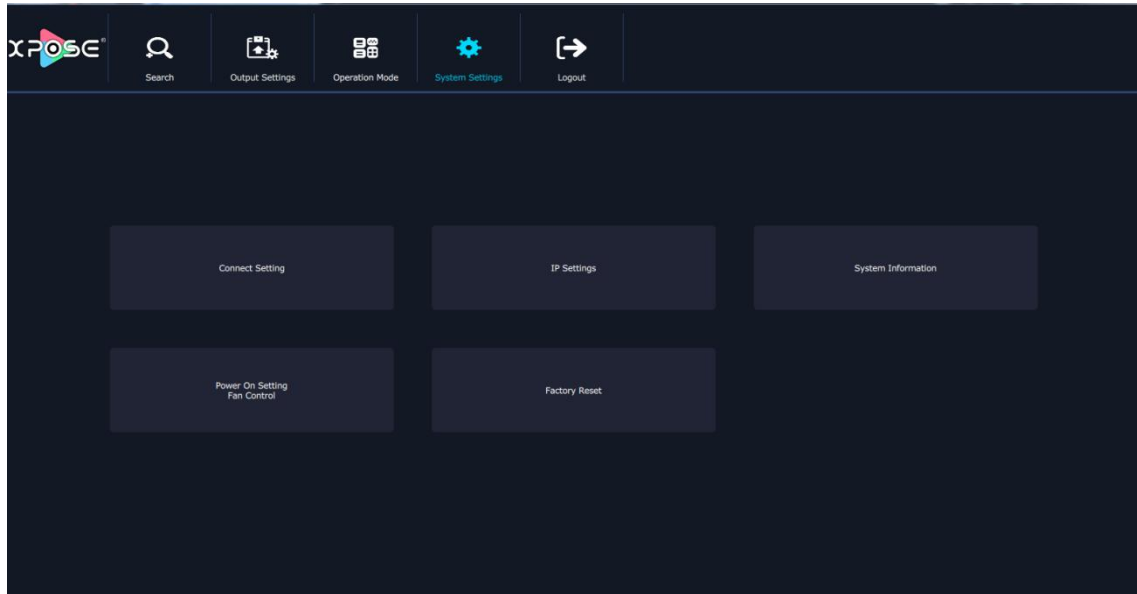

### Connect Setting

Click “Connect Setting”: Select “COM Port” and “Baud Rate”, click the drop down arrow after them, and click “OK”.

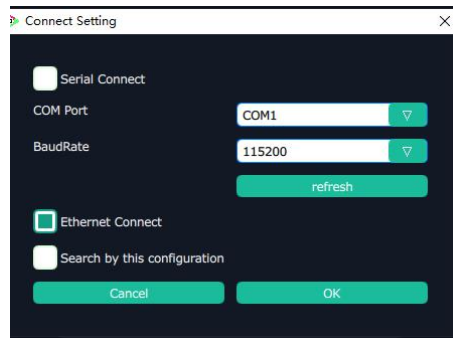

Setting the device connecting ways: Serial Connect, Ethernet Connect and Search by this configuration.

After setting “COM Port” and “Baud Rate”, pop-up window as follows:

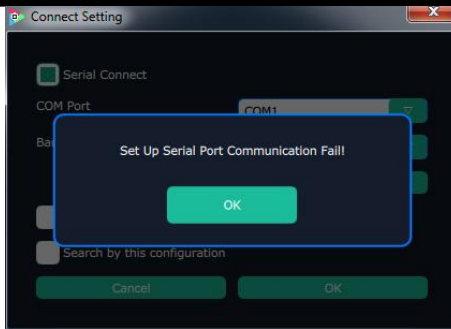

## IP Settings

Click the “IP Settings”, and pop-up window as follows:

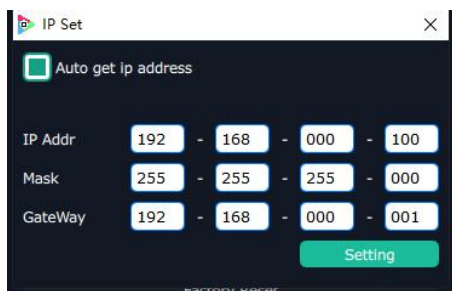

Default “Auto get IP address”. Users can also set IP address, Mask and GateWay manually. This is usually used if one computer control some devices or remote control. It takes effect after reboot the software if change IP through network.

## System Information

Click “System Information”, and pop-up window as follows:





Display the device version information. Including Model Number, Serial Number, IP Address, firmware version, etc.

### Factory Reset

Click "Factory Reset", and pop-up window as follows:

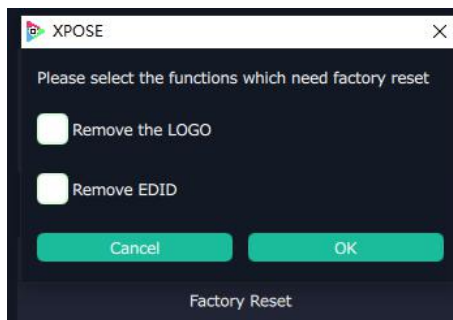

Click "OK" or "Cancel" to confirm the reset.

---

### Power On Setting Fan Control

To enable Delay Power On Setting, slide OFF to ON, set Time-Lapse Power On in 0~255S.

To disable Auto Fan control setting, slide OFF to ON, Set Fan Speed at 0~100

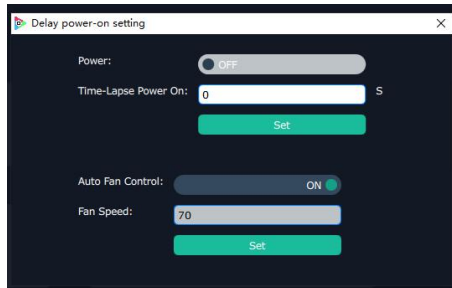

### 3.2.8 Logout



Click "Logout" to exit the XPOSE software, and pop up window as follows:

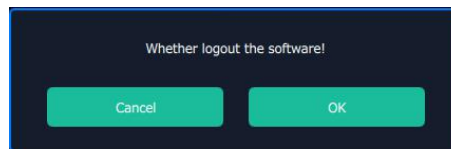

Click "cancel" or "OK" to confirm

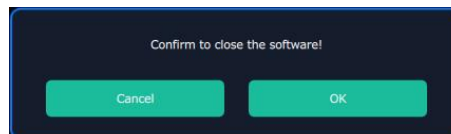

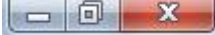
User also can be click the right corner  red button to exit software directly

---

# Chapter 4 Ordering Codes

---

## 4.1 Product

710-0008-01-0 FLEX 8

## 4.2 Modules

### 4.2.1 Input

190-0001-10-2	Single USB2.0 Input/Backup Input Module
190-0001-07-2	Single 3G SDI In/Loop Module
190-0001-13-2	Single HDMI Input Module
190-0001-04-2	Single DVI Input Module
190-0002-29-0	Single HDBaseT Input Module
980-0004-01-0	Single EXT4F-IM Input Interface

### 4.2.2 Output

790-0001-21-0	Single DVI Output Module
790-0001-24-0	Single 3G SDI Output Module
790-0001-27-0	Single DP Output Module
190-0002-30-0	Single HDBaseT Output Module
980-0002-01-0	EXT4F-OS Splicing Output Module
980-0003-01-0	EXT4F-OM Matix Output Module

### 4.2.3 Others

980-1002-01-0	Matrix Front Panel
980-1001-01-0	Basic Front Panel

---

# Chapter 5 Support

---

## Contact Us



**Web**  
[www.rgblink.com](http://www.rgblink.com)

**Phone**  
+86-592-577-1197

**Email**  
Sales [sales@rgblink.com](mailto:sales@rgblink.com)  
Support [support@rgblink.com](mailto:support@rgblink.com)

### Social Media



@RGLINK

/rgblink

+rgblink

/rgblink

rgblink

rgblink

# Chapter 6 Appendix

## 6.1 Specification

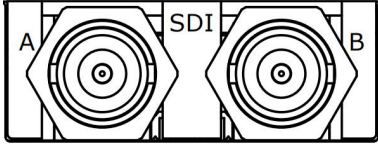
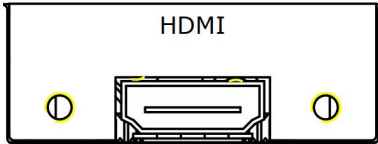
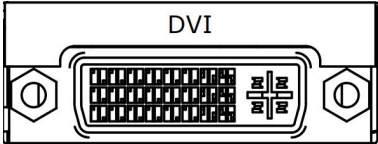
SDI Input/Loop Module	
Connector Appearance	
Numbers of Connectors	2 (1 In/1Loop)
Connectors	BNC
Supported Standard	SMPTE 425M (Level A & B)   SMPTE 424M   SMPTE 292M   SMPTE 259M-C   DVB-ASI
Supported Resolutions	SMPTE 480i   576i   720p@50/59.94/60   1080i@50/59.94/60   1080p@23.98/24/25/29.97/30/50/59.94/60
HDMI Input Module	
Connector Appearance	
Numbers of Connectors	1
Connectors	HDMI-A
Supported Standard	HDMI 1.3
Supported Resolutions	SMPTE 480i   576i   720p@50/59.94/60   1080i@50/59.94/60   1080p@50/59.94/60
	VESA 800×600@60   1024×768@60   1280×720@50/59.94/60   1280×800@60   1280×960@60   1280×1024@60   1400×1050@60   1600×1200@60   1920×1080@23.98/24/25/29.97/30/50/59.94/60
DVI Composite Input Module	
Connector Appearance	
Numbers of Connectors	1
Connectors	DVI-I (Compatible with VGA, CVBS, YPbPr via Adapter)
Supported Standard	DVI 1.0
	VGA UXGA

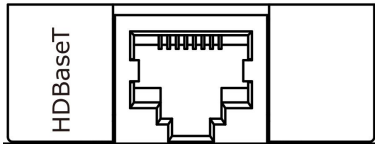
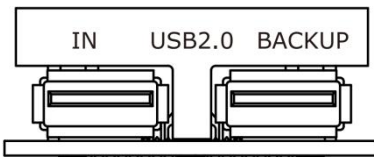
Supported Resolutions	SMPTE	480i   576i   720P@60   1080P@60			
	VESA	800×600@60   1024×768@60   1280×720@60   1280×800@60   1366×768@60   1400×1050@60   1600×1200@60   1920×1080@60			
<b>HDBaseT Input Module</b>					
Connector Appearance					
Connectors	RJ45				
Numbers of Connectors	1				
Supported Standard	HDBaseT	1.0			
Supported Resolution	SMPTE	720p@50/59.94/60   1080i@50/59.94/60   1080p@23.98/24/25/29.97/30/50/59.94/60			
	VESA	800×600@60/75/85   1024×768@60/75/85   1280×768@60   1280×800@60   1280×1024@60/75/85   1360×768@60   1366×768@60   1400×900@60   1600×1050@60   1600×1200@60   1680×1050@60   1920×1080@60   1920×1200@60   2048×1152@60   2560 ×816@60			
<b>USB2.0 Input Module</b>					
Connector Appearance					
Connectors	USB-A				
Supported Standard	USB 2.0				
Media Types	Video Formats	MPEG1   MPEG2   MPEG4   H264   RM   RMVB   MOV   MJPEG   VC1   DIVX   FLV			
	Image Formats	JPEG   BMP   PNG			
	Audio Formats	WMA   MP3   M4A   AAC			
Video Formats	File Type	File Extension	Encoding	Max Resolution	Max Bitrate
	MPEG1	.DAT   .MPG   .MPEG		1920×1080@30	20Mbps
	MPEG2	.MPG		1920×1080@30	20Mbps
	MPEG4	.AVI   .MP4   .3GP   .ASF	DVIX   XVID	1920×1080@30	20Mbps
	RM   RMVB	.RM   .RMVB	RV8   RV9	1280×720@3	10Mbps

			RV10	0	
	H264	.MKV   .MOV	H.264	1920×1080@30	20Mbps
	MJPEG	.AVI		640×480@30	10Mbps
	DivX	.DIVX   .AVI	MPEG   DVIX   H264	1920×1080@30	20Mbps
	VC1	.WMV   .ASF	VC1	1920×1080@30	20Mbps
	FLV	.FLV	H264	1920×1080@30	20Mbps
Picture Formats	File Type	Max Resolution	Compression	Supported Resolution	
	JPEG	15360×8640	Progressive JPEG	Support 1024×768 only	
			Baseline (“Standard”)	Full Range	
			Baseline Optimized	Full Range	
	BMP	9600×6400	Monochrome	Full Range	
			16-color	Full Range	
			256-color	Full Range	
			16 bit	Full Range	
			24 bit	Full Range	
			32 bit	Full Range	
	PNG	9600×6400	Non-interlaced	Full Range	

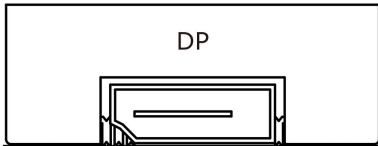
DP Output Module		
Connector Appearance		
Numbers of Connectors	1	
Connectors	DisplayPort	
Supported Standard	DP1.1	
Supported Resolution	SMPTE	720p@50/59.94/60   1080i@50/59.94/60   1080p@50/59.94/60
	VESA	800x600@60   1024x768@60   1280x720@50/59.94/60   1280x800@60   1280x960@60   1280x1024@60

		1400×1050@60   1600×1200@60   1920×1080@23.98/24/25/29.97/30/50/59.94/60
--	--	---

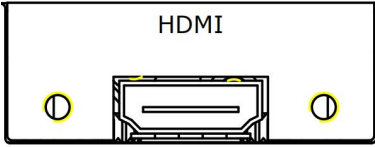
HDMI Output Module		
Connector Appearance		
Numbers of Connectors	1	
Connectors	HDMI-A	
Supported Standard	HDMI 1.3	
Supported Resolution	SMPTE	720p@50/59.94/60   1080i@50/59.94/60   1080p@50/59.94/60
	VESA	800×600@60   1024×768@60   1280×720@50/59.94/60   1280×800@60   1280×960@60   1280×1024@60   1400×1050@60   1600×1200@60   1920×1080@23.98/24/25/29.97/30/50/59.94/60

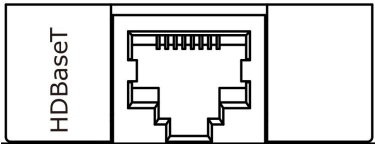
HDBaseT Output Module		
Connector Appearance		
Connectors	RJ45	
Numbers of Connectors	1	
Supported Standard	HDBaseT	1.0
Supported Resolution	SMPTE	720p@50/59.94/60   1080i@50/59.94/60   1080p@23.98/24/25/29.97/30/50/59.94/60
	VESA	800×600@60/75/85   1024×768@60/75/85   1280×768@60   1280×800@60   1280×1024@60/75/85   1360×768@60   1366×768@60   1400×900@60   1600×1050@60   1600×1200@60   1680×1050@60   1920×1080@60   1920×1200@60   2048×1152@60   2560 ×816@60

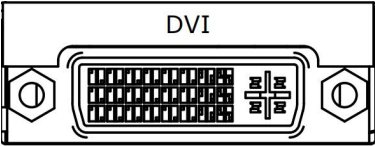
DVI Output Module		
Connector Appearance		
Numbers of Connectors	1	
Connectors	DVI-I (Compatible with VGA, CVBS, YPbPr via Adapter)	
Supported Standard	DVI	1.0

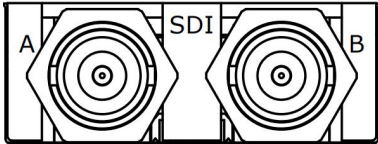

	VGA	UXGA
Supported Resolution	SMPTE	720P@60   1080P@60
	VESA	800×600@60   1024×768@60   1280×720@60  1280×800@60   1366×768@60   1400×1050@60   1600×1200@60   1920×1080@60
<b>SDI Output Module</b>		
Connector Appearance		
InputNumbers of Connectors	2 (1 In/1Loop)	
Connectors	BNC	
Supported Standard	SMPTE 425M (Level A & B)   SMPTE 424M   SMPTE 292M   SMPTE 259M-C   DVB-ASI	
Supported Resolution	SMPTE	720p@50/59.94/60  1080i@50/59.94/60  1080p@23.98/24/25/29.97/30/50/59.94/60

<b>Extras</b>	
Communication	LAN UART 1×RJ45 1×RJ11
Power Supply	AC 90-264V 50/60Hz 1.8A Max
Max Power	65W
Working Environment	0°C-40°C
Relativity Humidity	10% –85 % RH
Weight	4.5 kg
Dimensions	484mm × 449mm × 45mm
Product Warranty	3 years parts and labor warranty

---

## 6.2 Terms & Definitions

The following terms and definitions are used throughout this guide.

- **“ASCII”**: American Standard for Information Interchange. The standard code consisting of 7-bit coded characters (8 bits including parity check) used to exchange information between data processing systems, data communication systems, and associated equipment. The ASCII set contains control characters and graphic characters.
- **“Aspect ratio”**: The relationship of the horizontal dimension to the vertical dimension of an image. In viewing screens, standard TV is 4:3, or 1.33:1; HDTV is 16:9, or 1.78:1. Sometimes the “:1” is implicit, making TV = 1.33 and HDTV = 1.78.
- **“AV”**: Audio visual, or audio video.
- A **“Background”** is an unscaled source, typically originating from a computer. A background source appears at the system’s lowest priority — visually in back of all other sources.
- **“Baudrate”**: Named of J.M.E. Baudot, the inventor of the Baudot telegraph code. The number of the electrical oscillations per second, called baud rate. Related to, but not the same as, transfer rate in bits per second (bps).
- **“Blackburst”**: The video waveform without the video elements. It includes the vertical sync, horizontal sync, and the chroma burst information. Blackburst is used to synchronize video equipment to align the video output. One signal is normally used to set up an entire video system or facility. Sometimes it is called House sync.
- **“BNC”**: Bayonet Neill-Concelman. A cable connector used extensively in television and named for its inventors. A cylindrical bayonet connector that operates with a twist-locking motion. To make the connection, align the two curved grooves in the collar of the male connector with the two projections on the outside of the female collar, push, and twist. This allows the connector to lock into place without tools.
- **“Brightness”**: Usually refers to the amount or intensity of video light produced on a screen without regard to color. Sometimes called “black level.”
- **“CAT 5”**: Category 5. Describes the network cabling standard that consists of four unshielded twisted pairs of copper wire terminated by RJ-45 connectors. CAT 5 cabling supports data rates up to 100 Mbps. CAT 5 is based on the EIA/TIA 568 Commercial Building Telecommunications Wiring Standard.
- **“Color bars”**: A standard test pattern of several basic colors (white, yellow, cyan, green, magenta, red, blue, and black) as a reference for system alignment and testing. In NTSC video, the most commonly used color bars are the SMPTE standard color bars. In PAL video, the most commonly used color bars are eight full field bars. In the computer, the most commonly used color bars are two rows of reversed color bars.
- **“Color burst”**: In color TV systems, a burst of subcarrier frequency located on the back porch of the composite video signal. This serves as a color synchronizing

---

signal to establish a frequency and phase reference for the chroma signal. Color burst is 3.58 MHz for NTSC and 4.43 MHz for PAL.

- **“Color temperature”**: The color quality, expressed in degrees Kelvin(K), of a light source. The higher the color temperature, the bluer the light. The lower the temperature, the redder the light. Benchmark color temperature for the A/V industry include 5000°K, 6500°K, and 9000°K.
- **“Contrast ratio”**: The ratio of the high light output level divided by the low light output level. In theory, the contrast ratio of the television system should be at least 100:1, if not 300:1. In reality, there are several limitations. In the CRT, light from adjacent elements contaminate the area of each element. Room ambient light will contaminate the light emitted from the CRT. Well-controlled viewing conditions should yield a practical contrast ratio of 30:1 to 50:1.
- **“DVI”**: Digital Visual Interface. The digital video connectivity standard that was developed by DDWG (Digital Display Work Group). This connection standard offers two different connectors: one with 24 pins that handles digital video signals only, and one with 29 pins that handles both digital and analog video.
- **“EDID”**: Extended Display Identification Data – EDID is a data structure used to communicate video display information, including native resolution and vertical interval refresh rate requirements, to a source device. The source device will then output the optimal video format for the display based on the provided EDID data, ensuring proper video image quality. This communication takes place over the DDC – Display Data Channel.
- **“Ethernet”**: A Local Area Network (LAN) standard officially known as IEEE 802.3. Ethernet and other LAN technologies are used for interconnecting computers, printers, workstations, terminals, servers, etc. within the same building or campus. Ethernet operates over twisted pair and over coaxial cable at speeds starting at 10Mbps. For LAN interconnectivity, Ethernet is physical link and data link protocol reflecting the two lowest layers of the OSI Reference Model.
- **“Frame”**: In interlaced video, a frame is one complete picture. A video frame is made up of two fields, or two sets of interlaced lines. In a film, a frame is one still picture of a series that makes up a motion picture.
- **“Gamma”**: The light output of a CRT is not linear with respect to the voltage input. The difference between what you should have and what is actually output is known as gamma.
- **“HDMI” - High – Definition Multimedia Interface**: An interface used primarily in consumer electronics for the transmission of uncompressed high definition video, up to 8 channels of audio, and control signals, over a single cable. HDMI is the de facto standard for HDTV displays, Blu-ray Disc players, and other HDTV electronics. Introduced in 2003, the HDMI specification has gone through several revisions.
- **“HDSDI”**: The high-definition version of SDI specified in SMPTE-292M. This signal standard transmits audio and video with 10 bit depth and 4:2:2 color quantization over a single coaxial cable with a data rate of 1.485 Gbit/second. Multiple video resolutions exists including progressive 1280x720 and interlaced 1920x1080 resolution. Up to 32 audio signals are carried in the ancillary data.

- 
- **“JPEG” (Joint photographic Expects Group):** Commonly used method of lossy compression for photographic images using a discreet cosine transfer function. The degree of compression can be adjusted, allowing a selectable tradeoff between storage size and image quality. JPEG typically achieves 10:1 compression with little perceptible loss in image quality. Produces blocking artifacts.
  - **“MPEG”:** Motion Picture Expect Group. A standard committee under the auspices of the International Standards Organization working on algorithm standards that allow digital compression, storage and transmission of moving image information such as motion video, CD-quality audio, and control data at CD-ROM bandwidth. The MPEG algorithm provides inter-frame compression of video images and can have an effective compression rate of 100:1 to 200:1.
  - **“NTSC”:** The color video standard used in North America and some other parts of the world created by the National Television Standards Committee in the 1950s. A color signal must be compatible with black-and-white TV sets. NTSC utilizes an interlaced video signals, 525 lines of resolution with a refresh rate of 60 fields per second (60 Hz). Each frame is comprised of two fields of 262.5 lines each, running at an effective rate of 30 frames per second.
  - **“Operator”:** Refers to the person who uses the system.
  - **“PAL”:** Phase Alternate Line. A television standard in which the phase of the color carrier is alternated from line to line. It takes four full pictures (8 fields) for the color-to-horizontal phase relationship to return to the reference point. This alternation helps cancel out phase errors. For this reason, the hue control is not needed on a PAL TV set. PAL, in many transmission forms, is widely used in Western Europe, Australia, Africa, the Middle East, and Micronesia. PAL uses 625-line, 50-filed (25 fps) composite color transmission system.
  - **“PIP”:** Picture-in-Picture. A small picture within a larger picture created by scaling down one of the images to make it smaller. Each picture requires a separate video source such as a camera, VCR, or computer. Other forms of PIP displays include Picture-by-Picture (PBP) and Picture-with-Picture (PWP), which are commonly used with 16:9 aspect display devices. PBP and PWP image formats require a separate scaler for each video window.
  - **“Polarity”:** The positive and negative orientation of a signal. Polarity usually refers to the direction or a level with respect to a reference (e.g. positive sync polarity means that sync occurs when the signal is going in the positive direction).
  - **“RJ-45”:** Registered Jack-45. A connector similar to a telephone connector that holds up to eight wires, used for connecting Ethernet devices.
  - **“RS-232”:** An Electronic Industries Association (EIA) serial digital interface standard specifying the characteristics of the communication path between two devices using either DB-9 or DB-25 connectors. This standard is used for relatively short-range communication and does not specify balanced control lines. RS-232 is a serial control standard with a set number of conductors, data rate, word length, and type of connector to be used. The standard specifies component connection standards with regard to the computer interface. It is also called RS-232-C, which is the third version of the RS-232 standard, and is functionally identical to the CCITT V.24

---

standard.

- **“Saturation”**: Chroma, chroma gain. The intensity of the color, or the extent to which a given color in any image is free from white. The less white in a color, the truer the color or the greater its saturation. On a display device, the color control adjusts the saturation. Not to be confused with the brightness, saturation is the amount of pigment in a color, and not the intensity. Low saturation is like adding white to the color. For example, a low-saturated red looks pink.
- **“Scaling”**: A conversion of a video or computer graphic signal from a starting resolution to a new resolution. Scaling from one resolution to another is typically done to optimize the signal for input to an image processor, transmission path or to improve its quality when presented on a particular display.
- **“SDI”**: Serial Digital Interface. The standard based on a 270 Mbps transfer rate. This is a 10-bit, scrambled, polarity independent interface with common scrambling for both component ITU-R 601 and composite digital video and four channels of (embedded) digital audio.
- **“Seamless Switching”**: A feature found on many video switchers. This feature causes the switcher to wait until the vertical interval to switch. This avoid a glitch (temporary scrambling) which normally is seen when switching between sources.
- **“SMPTE”**: Society of Motion Picture and Television Engineers. A global organization, based in the United States, that sets standards for baseband visual communications. This includes film as well as video and television standards.
- **“S-Video”**: A composite video signal separated into the luma (“Y” is for luma, or black and white information; brightness) and the chroma (“C” is an abbreviation for chroma, or color information).
- **“Sync”**: Synchronization. In video, sync is a means of controlling the timing of an event with respect to other events. This is accomplished with timing pulses to insure that each step in a process occurs at the correct time. For example, horizontal sync determines exactly when to begin each horizontal scan line. Vertical sync determines when the image is to be refreshed to start a new field or frame. There are many other types of sync in video system.(Also known as “sync signal” or “sync pulse.”)
- **“TCP/IP”**: Transmission Control Protocol/Internet Protocol. The communication protocol of the Internet. Computers and devices with direct access to the Internet are provided with a copy of the TCP/IP program to allow them to send and receive information in an understandable form.
- **“USB”**: Universal Serial Bus. USB was developed by seven PC and telecom industry leaders (Compaq, DEC, IBM, Intel, Microsoft, NEC, and Northern Telecom). The goal was easy plug-and-play expansion outside the box, requiring no additional circuit cards. Up to 127 external computer devices may be added through a USB hub, which may be conveniently located in a keyboard or monitor. USB devices can be attached or detached without removing computer power. The number of devices being designed for USB continues to grow, from keyboards, mice, and printers to scanners, digital cameras, and ZIP drives.
- **“VESA”**: Video Electronics Standards Association. A nonprofit number organization

---

dedicated to facilitating and promoting personal computer graphics through improved standards for the benefit of the end-user. [www.vesa.org](http://www.vesa.org)

- **“VGA”**: Video Graphics Array. Introduced by IBM in 1987, VGA is an analog signal with TTL level separate horizontal and vertical sync. The video outputs to a 15-pin HD connector and has a horizontal scan frequency of 31.5 kHz and vertical frequency of 70 Hz (Mode 1, 2) and 60 Hz (Mode 3). The signal is non-interlaced in modes 1, 2, and 3 and interlaced when using the 8514/A card (35.5 kHz, 86 Hz) in mode 4. It has a pixel by line resolution of 640×480 with a color palette of 16 bits and 256,000 colors.
- **“YCrCb”**: Used to describe the color space for interlaced component video.
- **“YPbPr”**: Used to describe the color space for progressive-scan (non-interlaced) component video.

---

## 6.3 Revision History

The table below lists the changes to the User Manual of FLEX 8.

Format	Time	ECO#	Description	Personnel
V1.0	2019-4-29	0000#	Release	Fanny
V1.1	2019-9-26	0001#	Update	Fanny