



COB CANNON WASH ST DW



User Manual

©2021 ADJ Products, LLC all rights reserved. Information, specifications, diagrams, images, and instructions herein are subject to change without notice. ADJ Products, LLC logo and identifying product names and numbers herein are trademarks of ADJ Products, LLC. Copyright protection claimed includes all forms and matters of copyrightable materials and information now allowed by statutory or judicial law or hereinafter granted. Product names used in this document may be trademarks or registered trademarks of their respective companies and are hereby acknowledged. All non-ADJ Products, LLC brands and product names are trademarks or registered trademarks of their respective companies.

ADJ Products, LLC and all affiliated companies hereby disclaim any and all liabilities for property, equipment, building, and electrical damages, injuries to any persons, and direct or indirect economic loss associated with the use or reliance of any information contained within this document, and/or as a result of the improper, unsafe, insufficient and negligent assembly, installation, rigging, and operation of this product.

DOCUMENT VERSION



Due to additional product features and/or enhancements, an updated version of this document may be available online.

Please check www.adj.com for the latest revision/update of this manual before beginning installation and/or programming.

Date	Document Version	Software Version	DMX Channels	Notes
02/26/2019	1	1.0	1 / 2 / 4 / 4A / 5 / 6 / 7 Channels	Initial Release
05/15/2020	1.2	N/C	No Change	ETL Approved Added
09/16/2020	1.4	1.01	No Change	Updated primary/secondary
12/15/2021	1.6	N/C	No Change	Updated UC IR Control and Installation Instructions.

Europe Energy Saving Notice
Energy Saving Matters (EuP 2009/125/EC)

Saving electric energy is a key to help protecting the environment. Please turn off all electrical products when they are not in use. To avoid power consumption in idle mode, disconnect all electrical equipment from power when not in use. Thank you!

TABLE OF CONTENTS

FCC Statement	4
General Information	5
Limited Warranty (USA Only)	6
Safety Guidelines	7
Maintenance Guidelines	9
Overview	10
DMX Setup	11
Installation Instructions	13
System Menu	15
UC IR/Airstream Control	19
DMX Traits	21
Dimmer Curve Chart	22
Multi Unit Power Linking Primary-Secondary Setup	23
Cleaning and Maintenance Trouble Shooting Tips	24
Frequently Asked Questions Optional Accessories	25
Specifications	26
Dimensional Drawings	27

FCC STATEMENT

This device complies with Part 15 of the FCC Rules. Operation is subject to the following two conditions: (1) this device may not cause harmful interference, and (2) this device must accept any interference received, including interference that may cause undesired operation.

FCC RADIO FREQUENCY INTERFERENCE WARNINGS & INSTRUCTIONS

This product has been tested and found to comply with the limits as per Part 15 of the FCC Rules. These limits are designed to provide reasonable protection against harmful interference in a residential installation. This device uses and can radiate radio frequency energy and, if not installed and used in accordance with the included instructions, may cause harmful interference to radio communications. However, there is no guarantee that interference will not occur in a particular installation. If this device does cause harmful interference to radio or television reception, which can be determined by turning the device off and on, the user is encouraged to try to correct the interference by one or more of the following methods:

- Reorient or relocate the device.
- Increase the separation between the device and the receiver.
- Connect the device and the radio received to electrical outlets on different electrical circuits.
- Consult the dealer or an experienced radio/TV technician for help.



GENERAL INFORMATION

Introduction: Please read and understand all instructions in this manual carefully and thoroughly before attempting to operate these products. These instructions contain important safety and use information.

Unpacking: The products in this kit have been thoroughly tested and have been shipped in perfect operating condition. Carefully check the shipping carton for damage that may have occurred during shipping. If the carton appears to have been damaged, carefully inspect the unit for damage and be sure all accessories necessary to operate the unit have arrived intact. In the event that damage has been found or parts are missing, please contact our customer support team for further instructions. Please do not return this kit to your dealer without first contacting customer support at the number listed below. Please do not discard the shipping carton in the trash. Please recycle whenever possible.

Warranty Returns: All returned service items, whether under warranty or not, must be freight pre-paid and accompanied by a return authorization (R.A.) number. The R.A. number must be clearly written on the outside of the return package. A brief description of the problem as well as the R.A. number must also be written down on a piece of paper and included in the shipping container. If the unit is under warranty, you must provide a copy of your proof of purchase invoice. Items returned without an R.A. number clearly marked on the outside of the package will be refused and returned at customer's expense. You may obtain an R.A. number by contacting customer support.

ADJ PRODUCTS LLC USA

6122 S. Eastern Ave. Los Angeles, CA 90040
323-582-2650 | Fax 323-532-2941 | www.adj.com | info@adj.com

ADJ SUPPLY Europe B.V

Junostraat 2 6468 EW Kerkrade, The Netherlands
+31 (0)45 546 85 00 | Fax +31 45 546 85 99 | www.americandj.eu | info@americandj.eu

ADJ PRODUCTS GROUP Mexico

AV Santa Ana 30 Parque Industrial Lerma, Lerma, Mexico 52000
+52 (728) 282-7070 | ventas@adj.com

CUSTOMER SUPPORT

Contact ADJ Service for any product related service and support needs.
Please visit forums.adj.com with questions, comments, or suggestions.

ADJ SERVICE USA - Monday - Friday 8:00am to 4:30pm PST
800-322-6337 | Fax 323-832-2941 | support@adj.com

ADJ SERVICE EUROPE - Monday - Friday 08:30 to 17:00 CET
+31 45 546 85 60 | Fax +31 45 546 85 96 | support@adj.eu

REPLACEMENT PARTS please visit parts.adj.com

LIMITED WARRANTY (USA ONLY)

- A. ADJ Products, LLC hereby warrants, to the original purchaser, ADJ Products, LLC products to be free of manufacturing defects in material and workmanship for a prescribed period from the date of purchase (see specific warranty period on reverse). This warranty shall be valid only if the product is purchased within the United States of America, including possessions and territories. It is the owner's responsibility to establish the date and place of purchase by acceptable evidence, at the time service is sought.
- B. For warranty service, you must obtain a Return Authorization number (RA#) before sending the product back—please contact ADJ Products, LLC Service Department at 800-322-6337. Send the product only to the ADJ Products, LLC factory. All shipping charges must be prepaid. If the requested repairs or service (including parts replacement) are within the terms of this warranty, ADJ Products, LLC will pay return shipping charges only to a designated point within the United States. If the entire instrument is sent, it must be shipped in its original package and packaging material. No accessories should be shipped with the product. If any accessories are shipped with the product, ADJ Products, LLC shall incur no liability whatsoever for loss of or damage to any such accessories, nor for the safe return thereof.
- C. This warranty is void if the product serial number and/or labels are altered or removed; if the product is modified in any manner which ADJ Products, LLC concludes, after inspection, affects the reliability of the product; if the product has been repaired or serviced by anyone other than the ADJ Products, LLC factory unless prior written authorization was issued to purchaser by ADJ Products, LLC; if the product is damaged because it was not properly maintained as set forth in the product instructions, guidelines and/or user manual.
- D. This is not a service contract, and this warranty does not include maintenance, cleaning, or periodic checkup. During the period specified above, ADJ Products, LLC will replace defective parts at its expense with new or refurbished parts, and will absorb all expenses for warranty service and repair labor by reason of defects in material or workmanship. The sole responsibility of ADJ Products, LLC under this warranty shall be limited to the repair of the product, or replacement thereof, including parts, at the sole discretion of ADJ Products, LLC. All products covered by this warranty were manufactured after August 15, 2012, and bear identifying marks to that effect.
- E. ADJ Products, LLC reserves the right to make changes in design and/or improvements upon its products without any obligation to include these changes in any products theretofore manufactured.
- F. No warranty, whether expressed or implied, is given or made with respect to any accessory supplied with products described above. Except to the extent prohibited by applicable law, all implied warranties made by ADJ Products, LLC in connection with this product, including warranties of merchantability or fitness, are limited in duration to the warranty period set forth above. And all warranties, whether expressed or implied, including warranties of merchantability or fitness, are limited in duration to the warranty period set forth above. The consumer's and/or dealer's sole remedy shall be such repair or replacement as is expressly provided above; and under no circumstances shall ADJ Product, LLC be liable for any loss and/or damage, direct and/or consequential arising out of the use of, and/or inability to use this product.
- G. This warranty is the only written warranty applicable to ADJ Products, LLC products, and supersedes all prior warranties and written descriptions of warranty terms and conditions heretofore published.

MANUFACTURER'S LIMITED WARRANTY PERIODS:

- Non-LED Lighting Products = 1-Year (365 Days) (Including Special Effect Lighting, Intelligent Lighting, UV lighting, Strobes, Fog Machines, Bubble Machines, Mirror Balls, Par Cans, Trussing, Lighting Stands, Power/Data Distribution, etc. excluding LED and lamps)
- Laser Products = 1-Year (365 Days) (excluding laser diodes which have a 6-Month Limited Warranty)
- LED Products = 2-Year (730 Days) (excluding batteries which have a 180 Day Limited Warranty)
- NOTE: 2-Year (730 Days) Limited Warranty ONLY applies to product purchased within the United States. StarTec Series = 1-Year (365 Days) (excluding batteries which have a 180 Day Limited Warranty)
- ADJ DMX Controllers = 2 Year (730 Days)
- American Audio Products = 1 Year (365 Days)

SAFETY GUIDELINES

To guarantee smooth operation, it is important to follow all instructions and guidelines in this manual. ADJ PRODUCTS LLC is not responsible for injury and/or damages resulting from the misuse of these devices due to the disregard of the information printed in this manual. Only qualified and/or certified personnel should perform installation of these devices, and only the original rigging parts included with these devices should be used for installation. Any modifications to these devices and/or the included mounting hardware will void the original manufacturer's warranty and increase the risk of damage and/or personal injury.



PROTECTION CLASS 1 – DEVICES MUST BE PROPERLY GROUNDED



THERE ARE NO USER SERVICEABLE PARTS INSIDE THESE DEVICES. DO NOT ATTEMPT ANY REPAIRS YOURSELF, AS DOING SO WILL VOID YOUR MANUFACTURER'S WARRANTY. DAMAGES RESULTING FROM MODIFICATIONS TO THESE DEVICES AND/OR THE DISREGARD OF SAFETY INSTRUCTIONS AND GUIDELINES IN THIS MANUAL VOID THE MANUFACTURER'S WARRANTY AND ARE NOT SUBJECT TO ANY WARRANTY CLAIMS AND/OR REPAIRS.



**DO NOT PLUG THIS UNIT INTO A DIMMER PACK!
DO NOT REMOVE THE COVER FOR ANY REASON!
NEVER OPERATE THIS UNIT WITH THE COVER REMOVED!
UNPLUG POWER DURING LONG PERIODS OF NON-USE
NEVER TOUCH LIGHT DURING OPERATION, AS SURFACE MAY BE HOT!
KEEP FLAMMABLE MATERIALS AWAY FROM THESE DEVICES!
DO NOT EXCEED OPERATING TEMPERATURES OF 185°F (85°C)!**



**INDOOR / DRY LOCATIONS USE ONLY!
DO NOT EXPOSE DEVICES TO RAIN AND/OR MOISTURE!**

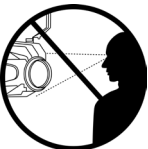

**NEVER LOOK DIRECTLY INTO THE LIGHT SOURCE!
RETINA INJURY RISK - MAY INDUCE BLINDNESS!
SENSITIVE PERSONS MAY SUFFER AN EPILEPTIC SHOCK!**

SAFETY GUIDELINES

- DO NOT position devices close to any FLAMMABLE MATERIALS during operation.
- DO NOT attempt installation and/or operation of devices without knowledge of how to do so.
- DO NOT permit operation by persons who are not qualified to operate these types of devices.
- DO NOT shake devices, and avoid brute force when installing and/or operating.
- DO NOT operate these devices if the main power cord has become frayed, crimped, and/or damaged. Replace any damaged power cords with new cords of the same power rating.
- DO NOT disassemble devices. There are NO user serviceable parts inside.
- ALWAYS disconnect devices from main power source before performing any cleaning.
- ALWAYS disconnect light from main power before replacing lamp.
- ALWAYS be sure to install these devices in an area that will allow proper ventilation.
- NEVER remove the ground prong from the power cable.
- Power cords should be safely routed and secured so they are not likely to get pinched.
- Disconnect power cords during long periods of non-use.
- Only use recommended rigging hardware as described in this guide.
- Use the original packaging and materials to transport these devices for service.
- These devices should be serviced by qualified service personnel when:
 - A. The power cords or plugs have been damaged.
 - B. Objects have fallen on and/or liquid has spilled into the devices.
 - C. The devices have been exposed to rain and/or moisture.
 - D. The devices do not operate normally or exhibit a marked change in performance.

MAINTENANCE GUIDELINES



DISCONNECT POWER BEFORE PERFORMING ANY MAINTENANCE!

CLEANING

Frequent cleaning is recommended to ensure proper function, optimized light output, and an extended life. The frequency of cleaning depends on the environment in which the devices operates: damp, smoky, or particularly dirty environments can cause greater accumulation of dirt on the mirror ball and/or light fixture optics. Periodically clean the external lens of the mirror ball surface and the front lens of the light with a soft cloth to avoid dirt/debris accumulation

NEVER use alcohol, solvents, or ammonia-based cleaners.

MAINTENANCE

Regular inspections are recommended to ensure proper function and extended life. There are no user serviceable parts inside these devices. Please refer all other service issues to an authorized ADJ service technician. Should you need any spare parts, please order genuine parts from your local ADJ dealer.

Please refer to the following points during routine inspections:

- A detailed review by an approved electrical engineer every three months, to make sure the circuit contacts are in good condition and prevent overheating.
- Be sure all screws and fasteners are securely tightened at all times. Loose screws may fall out during normal operation, resulting in damage or injury as larger parts could fall.
- Check for any deformations on the light, light housings, lenses, rigging hardware, and rigging points (ceiling, suspension, trussing). Deformations could allow for dust to enter into the devices. Damaged rigging points or unsecured rigging could cause the devices to fall and seriously injure a person(s).
- Electric power supply cables must not show any damage, material fatigue, or sediments.

OVERVIEW

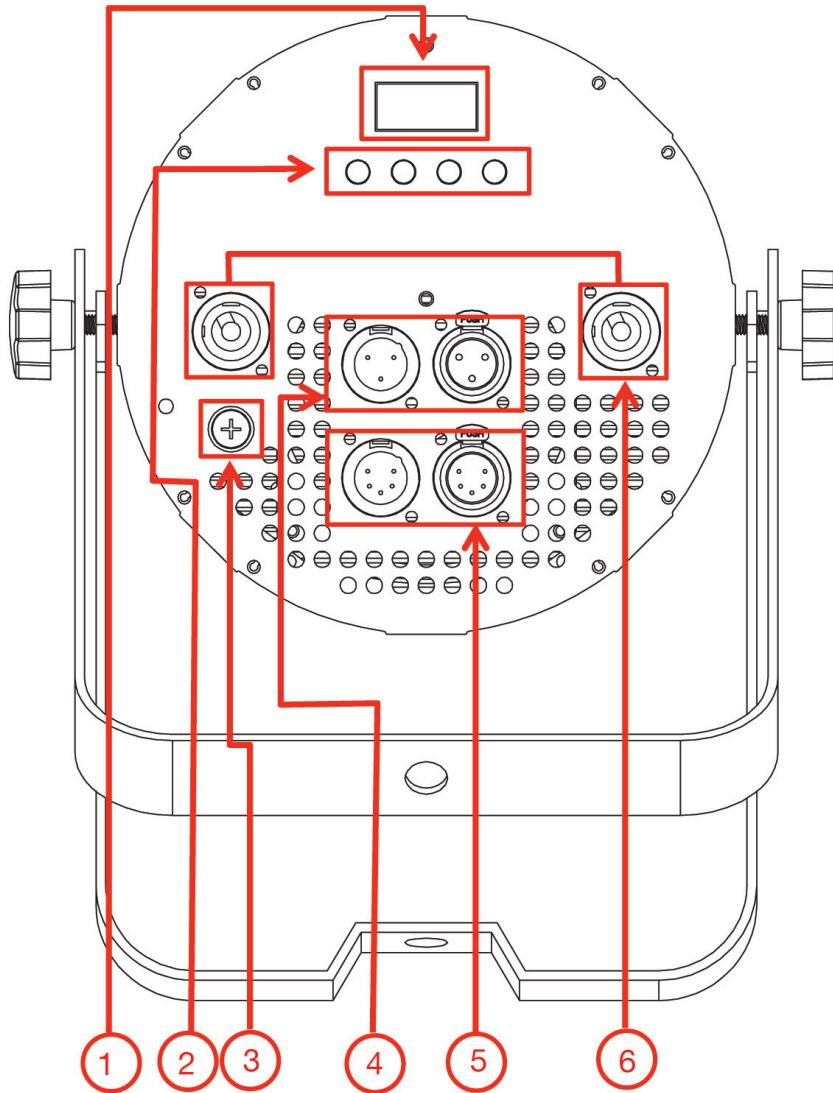

1. **Display:** Show the various menus and the selected functions.
2. **Button:**

MENU	Scroll through available functions
SET UP	Select and configure function
UP	Go backward in selected function
DOWN	Go forward in selected function

3. **Fuse:** 3 Amps
4. **DMX Input/Output:** 3-pin In/Out Connection
5. **DMX Input/Output:** 5-pin In/Out Connection
6. **Main Input/Output:** Power main connection

DMX SETUP

POWER SUPPLY

The COB Cannon Wash ST DW contains an automatic voltage switch, which will automatically sense the voltage when it is plugged into the power source. With this switch, there is no need to worry about the correct power voltage, and this unit can be plugged in anywhere.

DMX-512

DMX is short for Digital Multiplex. This is a universal protocol used by most lighting and controller manufacturers as a form of communication between intelligent fixtures and controllers. A DMX controller sends DMX data instructions from the controller to the fixture. DMX data is sent as serial data that travels from fixture to fixture via the DATA “IN” and DATA “OUT” XLR terminals located on all DMX fixtures (most controllers only have a DATA “OUT” terminal).

DMX LINKING

DMX is a language allowing all makes and models of different manufacturers to be linked together and operate from a single controller, as long as all fixtures and the controller are DMX compliant. To ensure proper DMX data transmission, try to use the shortest cable path possible when linking several DMX fixtures. The order in which fixtures are connected in a DMX line does not influence the DMX addressing. For example, a fixture assigned a DMX address of 1 may be placed anywhere in a DMX line: at the beginning, at the end, or anywhere in the middle. Therefore, the first fixture controlled by the controller could be the last fixture in the chain. When a fixture is assigned a DMX address of 1, the DMX controller knows to send DATA assigned to address 1 to that unit, no matter where it is located in the DMX chain.

DATA CABLE (DMX CABLE) REQUIREMENTS:

The COB Cannon Wash ST DW can be controlled via DMX-512 protocol, and has seven DMX channel modes. The DMX address is set electronically using the controls on the rear panel of the unit. Your unit and your DMX controller require an approved DMX-512 110 Ohm Data cable for data input and data output (Figure 1). We recommend AccuCable DMX cables. If you are making your own cables, be sure to use standard 110-120 Ohm shielded cable (This cable be purchased at almost all professional sound and lighting stores). Your cables should be made with a male XLR connector at one end and a female XLR connector at the other. Also remember that DMX cable must be daisy chained and cannot be split.



Figure 1

DMX SETUP

NOTICE

Be sure to follow figures two and three when making your own cables. Do not use the ground lug on the XLR connector. Do not connect the cable's shield conductor to the ground lug or allow the shield conductor to come in contact with the XLR's outer casing. Grounding the shield could cause a short circuit and result in erratic behavior.

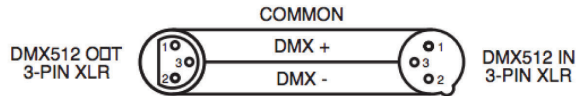

Figure 2

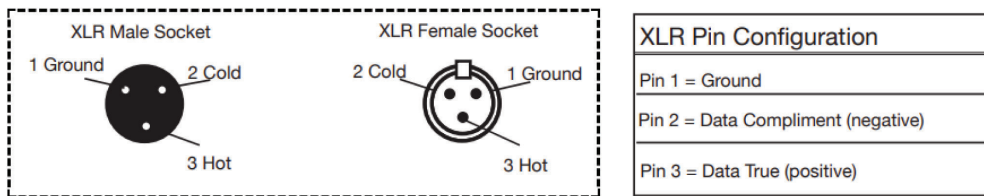

Figure 3

SPECIAL NOTE: LINE TERMINATION

When longer runs of cable are used, you may need to use a terminator on the last unit to avoid erratic behavior. A terminator is a 110-120 ohm 1/4 watt resistor, which is connected between pins 2 and 3 of a male XLR connector (DATA + and DATA -). This unit is inserted in the female XLR connector of the last unit in your daisy chain to terminate the line. Using a cable terminator (ADJ part number Z-DMX/T) will reduce the risk of erratic behavior.

Figure 4

DMX512 IN
3-PIN XLR

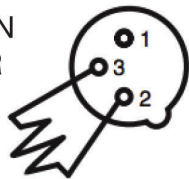

Termination reduces signal errors and avoids signal transmission problems and interference. It is always advisable to connect a DMX terminal, (Resistance 120 Ohm 1/4 W) between PIN 2 (DMX-) and PIN 3 (DMX +) of the last fixture.

INSTALLATION INSTRUCTIONS

INSTALLATION

This unit should be mounted using a mounting clamp (not provided), affixing it to the mounting bracket that is provided with the unit. Always ensure that the unit is firmly fixed to avoid vibration and slipping while operating. Always ensure that the structure to which you are attaching the unit is secure and is able to support at least ten (10) times the weight of the unit plus any mounting accessories. A safety cable (optional) is required when installing the fixture. It is also recommended that a professional install the equipment, and that the unit be installed in a place where it is out of the reach of people's grasp.

The unit is capable of being mounted in any of the orientations shown in the diagram below:

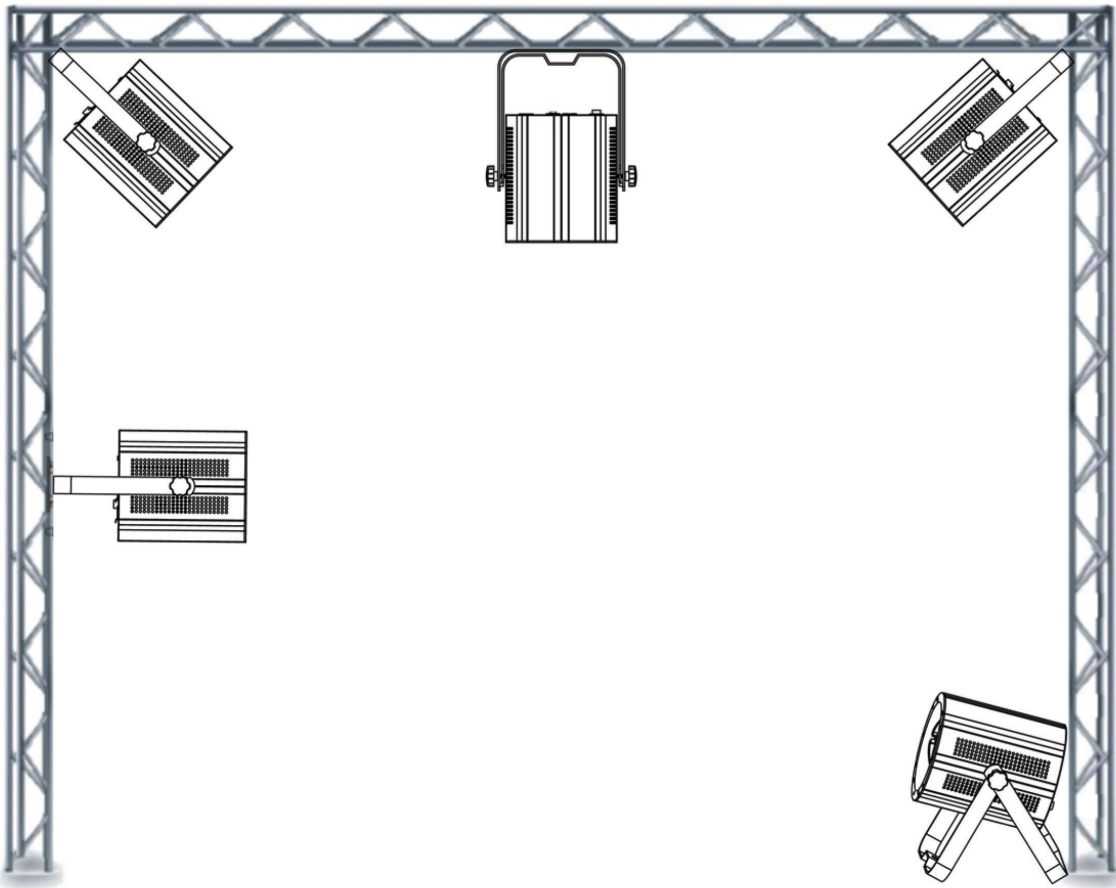

INSTALLATION INSTRUCTIONS

OPTIONAL LENS CHANGE

The COB Cannon Wash ST DW comes with an 80-degree lens already attached. Included in the box are optional 40 & 50-degree lenses. To switch lenses, follow the steps below:

1. Remove the retainer ring located in front of the current lens.
2. Carefully remove the lens, and attach your desired lens.
3. Reinstall the retainer ring. The switch is now complete.

Note: When reinstalling the retainer ring, make sure to insert 3 points of the retainer ring into the 3 notches located around the inside of the lens frame.

SYSTEM MENU

MODES

The COB Cannon Wash ST DW has 7 modes: 1-channel, 2-channel, 4-channel, 4A-channel, 5-channel, 6-channel, and 7-channel.

During operation, the display will lock after 30 seconds. To unlock the display, press and hold the MODE button for 3 seconds.

MODE	SETUP	UP/DOWN	DESCRIPTION
DMX	d.xxx	d.001 ~ d.512	Set DMX starting address
	Chxx	Ch01	Set DMX channel mode
		Ch02	
		Ch04	
		Ch4A	
		Ch05	
		Ch06	
		Ch07	
	No DMX	bLAc	Unit goes into blackout mode when DMX signal is lost or interrupted
		LASt	Unit holds last state when DMX signal is lost or interrupted
ProG		Unit default to Auto mode and runs internal programs when DMX signal is lost or interrupted	
dr-x	dr-0 ~ dr-5	Select delay mode	
SECOND-ARY	SECd		Set unit to secondary mode
DIMMER	h.xxx	h.000 ~ h.255	Adjust warm white intensity
	C.xxx	C.000 ~ C.255	Adjust cool white intensity
	FS.xx	FS.00 ~ FS.15	Adjust flash speed; FS.00 is off, FS.01 is slowest, FS.15 is fastest
SOUND	Soxx	So01 ~ So08	Select from 8 built-in sound modes
	SJ-x	SJ-0 ~ SJ-8	Adjust sound sensitivity level; SJ-1 is lowest, SJ-8 is highest
AUTO RUN	AFxx	AF01 ~ AF08	Select from 8 built-in dreaming modes
	AJxx	AJ01 ~ AJ08	Select from 8 built-in jumping modes
	SP.xx	SP.01 ~ SP.16	Adjust speed of dreaming/jumping modes
	A-JF		Activate combined dreaming & jumping mode, in which unit alternates between dreaming and jumping in a continuous cycle
CONTINUED ON NEXT PAGE			

SYSTEM MENU

MODE	SETUP	UP/DOWN	DESCRIPTION
STATIC COLOR SELECT	CLxx	CL00 ~ CL08	Select from 8 static colors
	FS.xx	FS.00 ~ FS.15	Adjust flash speed; FS.00 is off, FS.01 is slowest, FS.15 is fastest
OTHER	dxxx	don	LED display always on
		doff	LED display off
	lrxx	Iron	IR remote function on
		lroff	IR remote function off
	Stnd / rev	Stnd	LED display standard orientation
		rev	LED display inverted
dEFA		Initialize unit at the factory setting	

SYSTEM MENU

DMX Mode: Operating through a DMX controller gives the user the freedom to create their own programs tailored to their own individual needs. See the **DMX Traits** section of this manual for detailed information. Press the MODE button to select the DMX mode.

DMX Addressing and Channel Mode: This function will allow you to control each individual fixture's traits with a standard DMX 512 controller. (When a DMX Address is set, the LED display will flicker if there is no signal from the controller.)

1. To run your fixture in DMX mode, press the MODE button until "d.XXX" is displayed. "XXX" represents the current selected DMX address.
2. Use the UP or DOWN buttons to select your desired DMX address, then press the SET UP button to select your DMX Channel mode.
3. Use the UP or DOWN button to scroll through the DMX Channel modes (Ch01, Ch02, Ch04, Ch4A, Ch05, Ch06, or Ch07).

No DMX Setup: This mode allows the unit to default to one of three modes if the DMX signal is lost or interrupted

1. Press the SET UP button to select your setting.
2. Press the UP or DOWN button to select one of the three options.
 - BLACKOUT = "blAc". The unit will switch all LED's off if signal is lost.
 - HOLD = "LAsT". The unit will hold the last state before the signal was lost.
 - AUTO = "ProG". The unit will run the default internal programs.

Delay Mode: Select the unit delay mode by pressing the SET UP button until "dr-X" is displayed. Press the Up or Down button to set the delay rate 0-5. After you have chosen your desired DMX Channel mode, plug in the fixture via the XLR connections to any standard DMX controller.

Ssecondary Mode: Press the MODE button to select the Secondary mode. Secondary mode will be displayed as "SECd".

Note: While in Secondary mode, the SET UP, UP, and DOWN buttons will not function.

Dimmer Mode: Press the MODE button to select the Dimmer mode.

1. Press the UP or DOWN to cycle between warm white (h.xxx), cool white (C.xxx), and flash speed (FS.xx). Press SET UP to select the option displayed on the screen.
2. Press the Up or Down button to adjust the selected setting. Selectable values for Warm White and Cool White range from 000 to 255, while Flash ranges from 00 to 15 (00 = flash off, 01 = slowest flash, 15 = fastest flash).

SYSTEM MENU

Sound Mode: In this mode, the COB Cannon Wash ST DW will react to sound, and chase through the different colors. Press MODE button to select the Sound Active mode. Sound Active mode will be displayed as “SoXX” with “XX” representing Sound Active mode (1-8).

1. Press the SET UP button to adjust the sound sensitivity. “SJ-X” should be displayed.
2. Press the UP or DOWN button to adjust the sensitivity level from 1 (off) to 8 (highest).

Auto Run Program Mode: There are 3 types of Auto Run Modes to choose from: Color Fade, Color Change, and both modes running together. The running speed is adjustable in all 3 modes. Press the MODE button until “AFXX”, “AJXX”, or “A-JF” is displayed.

- Dreaming Mode (AFxx): Choose from 16 color fade modes. Use the UP and DOWN buttons to scroll through the different modes.
- Jumping Mode (AJxx): Choose from 16 color change modes. Use the UP and DOWN buttons to scroll through the different modes.
- Both Dreaming and Jumping Modes (A-JF).

After you have chosen your desired running mode, press the SET UP button until “SP.XX” is displayed. When this is displayed you can adjust the running speed of your desired program. Use the UP or DOWN button to adjust the speed between “SP.01” (slowest) and “SP.16” (fastest). Once you have set your desired running speed, press the SET UP button to return to your desired Auto Run Mode.

Static Color Select Mode: Choose between 64 static colors and activate/deactivate strobe.

1. Press MODE button to select the Static Color Select mode.
2. Press the SET UP button until “CLXX” or “FSXX” is displayed.
 - Static Color Mode = “CLXX”. There are 8 static colors to choose from. Use the UP or DOWN button to select desired static color.
 - Flash Speed Select = “FS.XX”. Use the UP or DOWN button to adjust between “FS.00” (flash off), and “FS.01” (slowest flash) to “FS.15” (fastest flash).

Other Program Select Mode: There are 4 “Other” setup features to adjust. LED Display On/Off, IR Remote On/Off, Display Inversion, and Initialization. Press the MODE button until “doXX”, “IrXX”, “Stnd” or “dEFA” is displayed.

- LED Display On/Off = “doXX”. Set the LED display to turn off after 60 seconds by pressing UP or DOWN button to display “doff”. The display will turn off after 60 seconds and will reappear with the press of a button. Be advised that it will turn off again automatically after 60 seconds of inactivity. Selecting “don “ will set the LED display to On at all times.
- IR Remote Function On/OFF = “IrXX”. Press UP or DOWN button to display “Iron” to enable IR remote function or to “IroF” to disable IR remote function.
- LED Display Inversion = “Stnd”. Press UP or DOWN button to invert to display 180 degrees.
- Initialization select mode = “dEFR”. Press the UP and DOWN buttons simultaneously to restore all modes to default settings. Press the MODE button to exit.

UC IR/AIRSTREAM CONTROL

WIRELESS SETUP

There are many factors that can affect and/or interrupt a wireless signal, including walls, glass, metal, objects, and people. Therefore, the following guidelines are recommended in order to maximize the chances of having a clear path for the wireless signal to reach the device:

- Install the device a minimum of 9.8 ft (3m) above audiences and/or ground level.
- Arrange the wireless antenna in an upright, vertical position.
- Position devices in direct line of sight of the transmitting controller.

Careful planning and testing of the selected installation location is critical to ensure optimum and reliable wireless operation.

9.8 ft (3m)
Above Ground



UC IR REMOTE

The unit should respond to commands issued from the UC IR Remote. **NOTE: The unit can only be controlled when it has been set to Primary mode. The unit will NOT respond to commands when it has been set to Secondary mode.**



UC IR/AIRSTREAM CONTROL

WIRELESS FUNCTIONS

The UC IR (sold separately) infrared remote gives you control of various functions (See below). To control the fixture you must aim the remote at the front of the fixture and be no more than 30 feet away.

Airstream IR (sold separately): The remote transmitter plugs into the headphone jack of your iOS phone or tablet. To control your IR fixture, you must raise the volume to the maximum on your iOS phone or tablet and aim the transmitter at the fixture sensor. Maximum operating range is 15 feet. After you have purchased the Airstream IR transmitter, the app is a free download from the app store for your iOS phone or tablet. The app comes with 3 pages of control depending on the fixture you are using. Please see the information below for the IR Functions in the corresponding app page.

Works with App Page 1.

UC IR Remote Controls: The UC IR Remote can only be used if “IR Remote Function” is set to “On” (see the **System Menu** section of this manual for detailed instructions on enabling IR Remote Function).

- **STAND BY** - Pressing this button will blackout the fixture. Press the button again to return to the initial state.
- **FULL ON:** Press this button to fully light up the unit.
- **FADE/GOBO:** Press this button to switch between Color Fade, Color Change, and Auto Run mode.
- **DIMMER + / DIMMER -:** Use to adjust the color output intensity when color mode is active.
- **STROBE:** Press this button for strobing, then press button ‘1’ to select slow strobe speed, button ‘2’ to select medium strobe speed, button ‘3’ to select fast strobe speed, or button ‘4’ to select faster strobe speed.
- **COLOR:** Press this button to activate color mode. Use buttons 1-9 to select your desired color.
- **1-9 BUTTONS:** Use buttons 1-4 to select your desired strobe speed when strobe mode is active. Use buttons 1-9 to select your desired color when color mode is active or your desired show when show mode is active.
- **SOUND ON / SOUND OFF:** Use the buttons to activate and deactivate sound active mode.
- **SHOW 0:** Press this button to select Show mode, then use buttons 1-9 to select Shows 1-9. Press the “Show 0” button twice to run Show #10, and press button ‘1’ twice to run show #11.

DMX TRAITS

CHANNEL							DMX VALUES	FUNCTION
1-CH	2-CH	4-CH	4A-CH	5-CH	6-CH	7-CH		
	1	1	1	1	1	1	000 - 255	Cool White , 0% to 100%
			2				000 - 255	Cool White Fine , 0% to 100%
	2	2	3	2	2	2	000 - 255	Warm White , 0% to 100%
			4				000 - 255	Warm White Fine , 0% to 100%
1				3	3	3		Variable White
							000	Off
							001 - 255	3200K to 6400K Linear
					4	4		Strobe
							000 - 031	LED Off
							032 - 063	LED On
							064 - 095	Strobe, slow to fast
							096 - 127	LED On
							128 - 159	Strobe Pulse, slow to fast
							160 - 191	LED On
							192 - 223	Random Strobe, slow to fast
					224 - 255	LED On		
		3		4	5	5	000 - 255	Master Dimmer , 0% to 100%
		4		5	6	6	000 - 255	Master Dimmer Fine , 0% to 100%
						7		Dimmer Modes
							000 - 020	Standard
							021 - 040	Stage
							041 - 060	TV
							061 - 080	Architectural
							081 - 100	Theatre
							101 - 120	Stage 2
						121 - 255	Default to unit setting	

DIMMER CURVE CHART

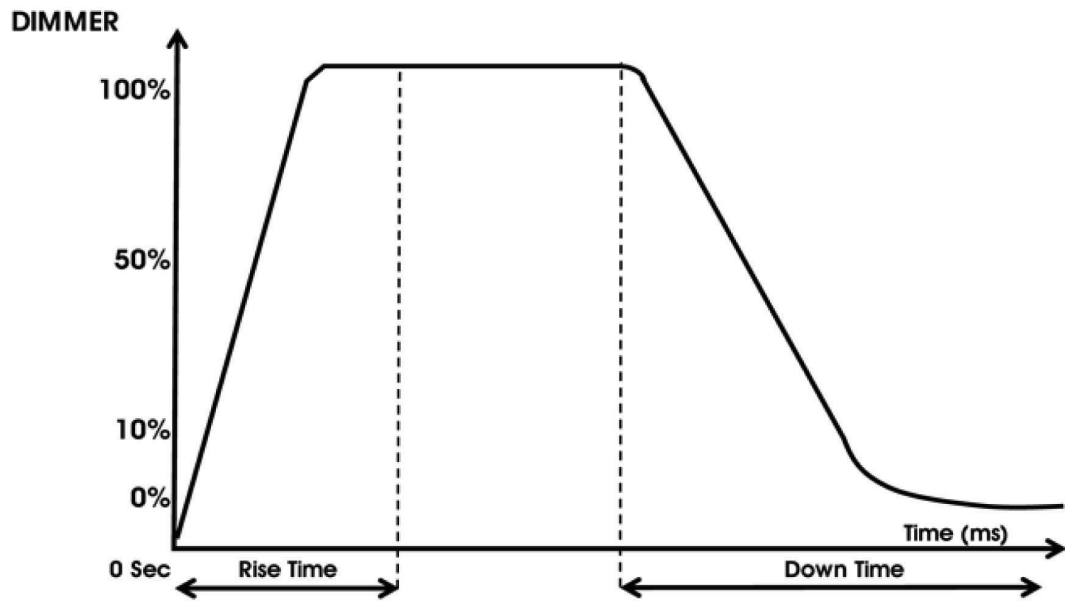

Dimming Curve Ramp Effect	0 sec Fade Time		1 sec Fade Time	
	Rise Time (ms)	Down Time (ms)	Rise Time (ms)	Down Time (ms)
Standard (default)	0	0	0	0
Stage	780	1100	1540	1660
TV	1180	1520	1860	1940
Architectural	1380	1730	2040	2120
Theatre	1580	1940	2230	2280
Stage 2	0	1100	0	1660

MULTIPLE UNIT POWER LINKING

With this feature you can connect the fixtures to one another using the power cable input and output sockets.

The maximum number of devices that can be linked in this manner is 3 units.

NOTE: USE CAUTION WHEN POWER LINKING FIXTURES OF OTHER MODEL TYPES, AS THE POWER CONSUMPTION OF OTHER MODEL FIXTURES MAY EXCEED THE MAX POWER OUTPUT ON THIS FIXTURE! CHECK SILK SCREEN FOR MAX AMPS.

PRIMARY-SECONDARY SETUP

1. Daisy chain your units via the XLR connectors on the rear of the unit. Use standard XLR data cables to link your units together. Remember that the Male XLR connector is the input and the Female XLR connector is the output. The first unit in the chain (primary) will use the female XLR connector only, and the last unit in the chain will use the male XLR connector only.
2. Set the “Primary” unit to your desired mode of operation.
3. On the “Secondary” units, press the MODE button until “SECd” is displayed. Each “Secondary” unit must be set to the same setting.
4. Connect the first “Secondary” unit to the “Primary.” The “Secondary” unit(s) should now follow the “Primary” unit.

CLEANING AND MAINTENANCE

FUSE REPLACEMENT

Disconnect the unit from its power source, and remove the power cord from the unit. Use a Phillips head screwdriver to remove the fuse holder, which is located under the power connection. Remove the fuse located inside the fuse holder and replace with the new fuse. Install the fuse holder and new fuse and secure it back in place.

CLEANING

Due to fog residue, smoke, and dust, cleaning the internal and external optical lenses must be carried out periodically to optimize light output.

- Use normal glass cleaner and a soft cloth to wipe down the outside casing.
- Clean the external optics with glass cleaner and a soft cloth every 20 days.
- Always be sure to dry all parts completely before plugging the unit back in.

Cleaning frequency depends on the environment in which the fixture operates (i.e. smoke, fog residue, dust, dew).

TROUBLE SHOOTING TIPS

Unit does not turn on:

- Confirm the unit has AC power.
- Check if circuit breaker that controls the AC outlet plug has been tripped.
- Confirm the AC power cord from the light is not damaged or cut.
- Check the fuse and see if it needs to be replaced.
- If none of these solutions work, please contact ADJ Customer Service.

Unit does not respond to DMX:

Check that the DMX cables are connected and wired correctly (pin 3 is “hot”; on some other DMX devices pin 2 may be “hot”). Also, check that all cables are connected to the right connectors; the order in which the inputs and outputs are connected does affect the operation.

Unit does not respond to sound:

- Quiet or high-pitched sounds will not activate the unit.
- Make sure that Sound Active mode is activated.

FREQUENTLY ASKED QUESTIONS

Can you use barn doors with the COB Cannon Wash ST DW?

Yes, barn doors (BAR001) are an optional accessory and can be purchased separately.

Is the COB Cannon Wash ST DW flicker free?

Yes, the COB Cannon Wash ST DW features Flicker Free operation. At 1,000Hz, there should be no flickering on camera.

How many fixtures can be daisy chained together?

Up to 3 COB Cannon Wash ST DW units can be daisy chained together. Use caution when linking units of different model types, as the power draw may differ from model to model. Check Silk Screen for Max Amps to ensure the max load capacity is not exceeded.

OPTIONAL ACCESSORIES

Order Code	Description
AC5PDMX3	3-foot DMX cable with 5-pin male to 5-pin female connection*
AC5PDMX3PRO	Pro Series 3-foot DMX cable with 5-pin male to 5-pin female connection*
S-Cable/60	Safety Cable with 60-pound weight rating
O-CLAMP	360 degree clamp that wraps around truss tubing
PRO-CLAMP	360 degree aluminum clamp with a max rating of 1100 lbs
<i>* Additional lengths available at www.adj.com</i>	

SPECIFICATIONS

Model	COB Cannon Wash ST DW
Wattage	155 W
Light Source	1 x 150-watt COB Warm White/Cool White LED
Voltage	AC100V-240V/50Hz-60Hz
Beam Angle	80 Degrees (Optional 40-degree and 50-degree lenses included)
Working Position	Any safe working position
Power Cord Daisy Chain	3 fixtures max.
Fuse	3 Amp
Colors	Cool White & Warm White Mixing
DMX Channels	7 DMX Modes: 1-, 2-, 4-, 4A-, 5-, 6-, and 7-channel modes
Dimming	0-100% electronic dimming
Strobe	LED pulse and strobe effect
Flicker Free	Yes, 1000Hz
IP Rating	IP20 (indoor use only)
Weight	9.2 lbs / 4.2 Kgs
Dimensions (w/ bracket)	13" (L) x 10" (W) x 7.5" (H) 330mm x 256mm x 190mm
Dimensions (w/o bracket)	8.75" (L) x 7.5" (W) x 7.5" (H) 218mm x 190mm x 190mm
Warranty	2 Years (730 Days)

Please Note: Specifications and improvements in the design of this unit and this manual are subject to change without any prior written notice.

DIMENSIONAL DRAWINGS

