



▶▶ NEUMANN.BERLIN

- ▶ KH 120 II AES67
- ▶ KH 150 AES67

---

TWO-WAY ACTIVE LOUDSPEAKER

INSTRUCTION MANUAL





## Contents

<b>Studio Monitors KH 120 II AES67 and KH 150 AES67</b> .....	3
<b>Delivery includes</b> .....	3
<b>About this manual</b> .....	3
<b>Product overview: KH 120 II AES67</b> .....	4
<b>Product overview: KH 150 AES67</b> .....	5
<b>Setting up and connecting the loudspeaker</b> .....	6
Preparing the loudspeakers .....	6
Preparing the room .....	6
Positioning the loudspeakers .....	7
Connecting audio signals .....	8
Connecting a network cable for network control .....	10
Connecting/disconnecting the loudspeaker to/from the power supply system	11
<b>Configuring and using the loudspeaker</b> .....	11
Switching the loudspeaker on/off .....	11
Functionality of the Neumann logo .....	12
Switches on the SETTINGS panel .....	13
Resetting the loudspeaker settings .....	14
Firmware update .....	14
Adapting loudspeakers to the environment using the switches on the backplate .....	15
Adjusting the acoustical level .....	16
Configuring standby mode .....	17
Customizing standby behavior .....	18
<b>Configuring AES67 network and audio settings</b> .....	20
Initial setup .....	20
Selecting the control mode and audio input .....	20
Setting up the AES67 network interface .....	21
Setting up the PTP media clock .....	26
Setting up the connection management mode .....	28
Routing digital AES67 audio signals to the loudspeaker .....	30
Compatibility with DANTE® AES67 audio streams .....	35
<b>Cleaning and maintaining the loudspeaker</b> .....	37
<b>Troubleshooting</b> .....	37
<b>Specifications</b> .....	38
<b>Acoustical measurements and block diagram</b> .....	38
<b>Accessories</b> .....	38
<b>Installation angles</b> .....	39



## Studio Monitors KH 120 II AES67 and KH 150 AES67

Thank you for purchasing a Neumann studio monitor. The loudspeaker features a Mathematically Modeled Dispersion™ Waveguide (MMD™), DSP acoustical controls, a digital S/PDIF input and output, network control capabilities, and an extensive range of mounting hardware. This allows the loudspeaker to be used in diverse acoustical conditions, with any source equipment and in a wide variety of physical locations. The KH 120 II AES67 / KH 150 AES67 represents the latest in acoustic and electronic simulation and measurement technologies to ensure the most accurate sound reproduction possible.

The AES67 variants of the KH 120 II and KH 150 studio monitors support AES67 digital audio signals and act as an interface in an existing AES67 audio infrastructure in the studio. The integrated redundant AES67 audio network ports are fully compliant with ST 2110 and ST 2022-7 broadcast standards. The KH 120 II AES67 and the KH 150 AES67 also work with DANTE®-generated AES67 network streams.

Depending on the size, Neumann's two-way loudspeaker systems are designed for use as near field monitors or as rearward or ceiling-mounted loudspeakers in larger multi-channel systems. They can be used in project, music, broadcast, and post production studios for tracking, mixing, and mastering.

### Delivery includes

- 1 KH 120 II AES67 or KH 150 AES67
- 4 Self-adhesive feet
- 1 Quick guide
- 1 Safety instructions
- 1 Power cord (EU, UK, USA, China or Korea)

### About this manual

This operating manual describes the physical setup and autonomous operation of the loudspeaker. For information on how to control the speaker over a network using the **MA 1 – Automatic Monitor Alignment** software, please refer to the software help.

The **MA 1 – Automatic Monitor Alignment** software is available for macOS and Windows and offers the following advantages:

- Precise adaptation to your listening preferences
- Calibration to the listening environment
- Optimized stereo imaging
- Perfect matching of amplitude and phase to subwoofers
- Compensation for suboptimal listening situations
- Settings for system level, display brightness, delay and other features

The **MA 1 – Automatic Monitor Alignment** software is available at [www.neumann.com](http://www.neumann.com).



## Product overview: KH 120 II AES67

Front panel

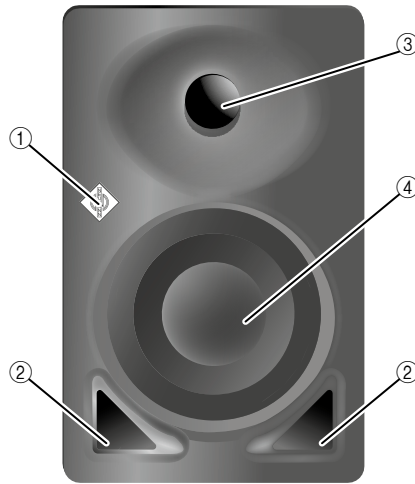

- ① Neumann logo
  - For information on the functionality of the Neumann logo, refer to the chapter “Functionality of the Neumann logo”
- ② Bass reflex ports
- ③ Tweeter with tweeter guard
- ④ Woofer with woofer guard

Back panel

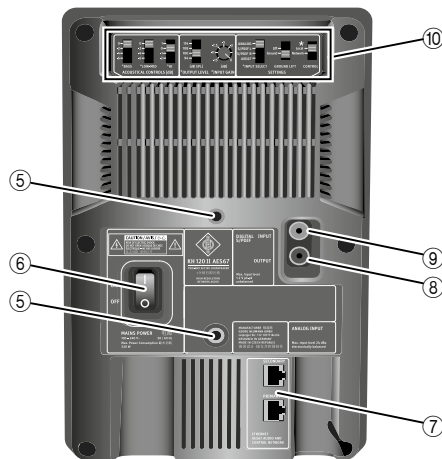

- ⑤ Threaded inserts (M6) for Neumann mounting hardware
- ⑥ On/off switch
- ⑦ Redundant ETHERNET jacks (RJ-45):  
PRIMARY | AES67 AUDIO AND CONTROL NETWORK  
SECONDARY | AES67 AUDIO
- ⑧ DIGITAL S/PDIF OUTPUT (RCA)
- ⑨ DIGITAL S/PDIF INPUT (RCA)
- ⑩ Control switches

Bottom

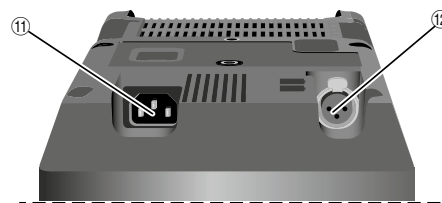

- ⑪ IEC power socket
- ⑫ Analog input (XLR-3F)



## Product overview: KH 150 AES67

Front panel

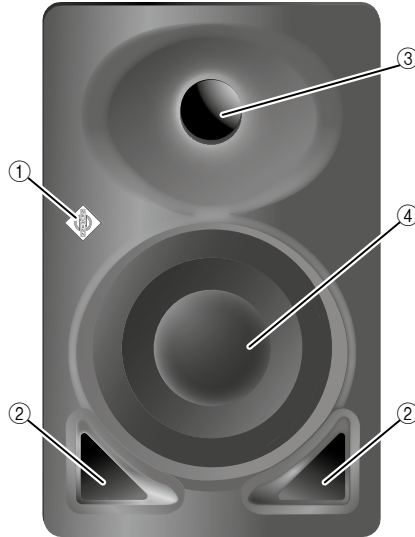

- ① Neumann logo
  - For information on the functionality of the Neumann logo, refer to the chapter “Functionality of the Neumann logo”
- ② Bass reflex ports
- ③ Tweeter with tweeter guard
- ④ Woofer with woofer guard

Back panel

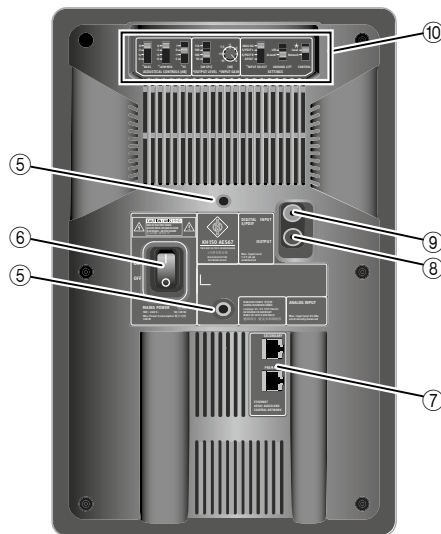

- ⑤ Threaded inserts (M6) for Neumann mounting hardware
- ⑥ On/off switch
- ⑦ Redundant ETHERNET jacks (RJ-45):  
PRIMARY | AES67 AUDIO AND CONTROL NETWORK  
SECONDARY | AES67 AUDIO
- ⑧ DIGITAL S/PDIF OUTPUT (RCA)
- ⑨ DIGITAL S/PDIF INPUT (RCA)
- ⑩ Control switches

Bottom

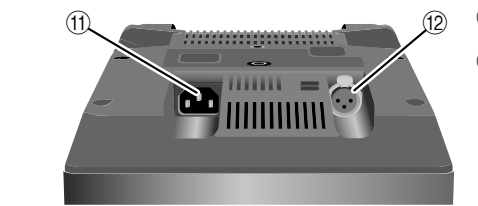

- ⑪ IEC power socket
- ⑫ Analog input (XLR-3F)



## Setting up and connecting the loudspeaker



### CAUTION

Danger of injury and material damage due to tipping/dropping of the product!

If improperly mounted, the product and/or the mounting hardware (e.g. rack) can tip over or fall.

- ▶ Always have the product mounted by a qualified specialist according to local, national and international regulations and standards.
- ▶ Use the mounting systems recommended by Neumann and always provide sufficient additional protection against tipping or falling.

### CAUTION

Damage to the product due to overheating!

If air cannot circulate properly around the cooling vents on the rear of the product, the amplifier(s) may overheat, leading to premature activation of the thermal protection system which limits the maximum output level of the loudspeaker. In rare cases, damage to the product may also occur.

- ▶ Never cover the cooling vents.
- ▶ When installing the product into tight spaces such as wall recesses, maintain an air gap of at least 5 cm around the top, rear and side panels of the product and provide sufficient air circulation. If necessary, use forced-air cooling.



For further information on setting up loudspeakers, please refer to the “Questions & Answers” section on the product page at [www.neumann.com](http://www.neumann.com).

For more information on building systems using Neumann loudspeaker products, please refer to the Product Selection Guide at [www.neumann.com](http://www.neumann.com)

## Preparing the loudspeakers

### CAUTION

Risk of staining surfaces!

Some surfaces treated with varnish, polish or synthetics may suffer from stains when they come into contact with other synthetics. Despite a thorough testing of the synthetics we use, we cannot rule out the possibility of staining.

- ▶ Do not place the loudspeaker on delicate surfaces.

To place the loudspeaker on a flat surface:

- ▶ Attach the supplied self-adhesive feet to the bottom of the cabinet.  
This reduces the risk of scratching the surface and acoustically isolates the loudspeaker from the surface.

## Preparing the room

- ▶ Arrange all acoustically relevant surfaces and objects symmetrically on either side of the listening axis of the room (left/right).
- ▶ Minimize the sound that is reflected back to the listening position by using angled surfaces and/or acoustical treatment.



This product has been optimized for use in recording studios. In order to not affect the quality of playback, make sure that the product is used in an EMC (electromagnetically compatible) environment, ideally without electromagnetic radiation from other devices.



## Positioning the loudspeakers

- Carry out the following steps very accurately, since the more accurate the physical arrangement of the loudspeakers in the room, the more accurate the reproduction will be at the listening position.

- Distances**
- Observe the recommended distances between the loudspeakers and your listening position:
    - Recommended listening distance for KH 120 II AES67: 1.0 m – 2.0 m
    - Min./max. listening distance for KH 120 II AES67: 0.75 m – 4.0 m
    - Recommended listening distance for KH 150 AES67: 1.0 m – 2.5 m
    - Min./max. listening distance for KH 150 AES67: 0.75 m – 6.0 m

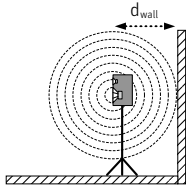

Angular positioning of the loudspeakers

- Avoid positioning the loudspeaker at a distance ( $d_{wall}$ ) of 0.8 to 1.75 m from the wall behind the loudspeaker. When positioning bass-managed loudspeakers, avoid a distance ( $d_{wall}$ ) of 0.8 to 1 m from a solid wall behind the loudspeaker. Similarly, avoid these distances from solid side walls or a solid ceiling. Respecting these positioning limitations reduces the chances of dips in the low frequency response (comb filtering) caused by strong reflections.

- Print out the “Installation angles” diagram that can be found at the end of this operating manual.
- Place the diagram at the listening position or the center of the listening area.
- Using a tape measure, place the loudspeakers at the same distance from the center of the diagram “Installation angles”. To ensure good imaging, do this at an accuracy of at least 1 cm.
- If the loudspeakers cannot be placed at the same distance from the listening position, compensate for distance differences > 1 cm by delaying closer loudspeakers by 30  $\mu$ s/cm. The **MA 1 – Automatic Monitor Alignment** software automatically compensates for different distances between the loudspeakers and the listening position.

- Arrange the loudspeakers as follows:
  - 2.0 systems (stereo):  $\pm 30^\circ$ , plus optional subwoofer(s)
  - 5.1 systems:
    - ITU-R BS.775-1:  $0^\circ, \pm 30^\circ, \pm 110^\circ (\pm 10^\circ)$ , plus optional subwoofer(s) (center, front left/right, surround left/right)
    - ANSI/SMPTE 202M:  $0^\circ, \pm 22.5^\circ$ , one surround array left and right, plus optional subwoofer(s)
  - 7.1 systems:  $0^\circ, \pm 30^\circ, \pm 90^\circ, \pm 150^\circ$ , plus optional subwoofer(s) (center, front left/right, side left/right, back left/right)
  - 3D systems: See the recommendations from Dolby, DTS, Auro3D and ITU-R BS.2051-0 for loudspeaker positioning.

The acoustical axis of the loudspeaker is between the bass and tweeter drivers.

- Always point the acoustical axis, in the horizontal and vertical planes, towards the listening position.

**i** The acoustical axis is a line perpendicular to the loudspeaker’s front panel along which the microphone was placed to tune the loudspeaker’s crossover when the monitor was designed. Pointing the acoustical axis, in the horizontal and vertical planes, toward the listening position or center of the monitoring area will give the best measured and perceived transient response quality.

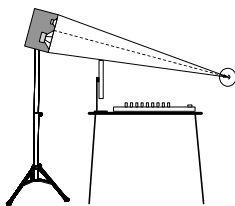
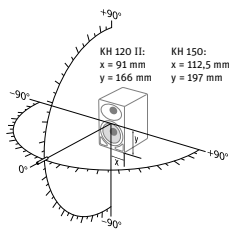

- Position the loudspeaker so that there is a direct line of sight from the listening position to the bass and tweeter drivers.
- Make sure that the ports are not blocked or partially covered.
- Keep sharp edges away from the port outlets, as they can cause air noise.



## Connecting audio signals

- ▶ Always use good quality cables to achieve the maximum cable lengths shown below:

Signal (connector)	Cable length	Connection method
Analog (XLR)	Up to 100 m	Directly to the ANALOG INPUT socket (XLR) (see below)
Analog (jack)	Up to 100 m	Via an adapter (jack–XLR) to the ANALOG INPUT socket (XLR) (see below)
Analog (RCA)	Up to 10 m	Via an adapter (RCA–XLR) to the ANALOG INPUT socket (XLR) (see below)
Digital (RCA)	Up to 200 m	Directly to the DIGITAL INPUT socket (RCA) (see below)
Digital (BNC)	Up to 200 m	Via an adapter (BNC–RCA) to the DIGITAL INPUT socket (RCA) (see below)
Digital (XLR)	Up to 50 m	Via an adapter (XLR–RCA) to the DIGITAL INPUT socket (RCA) (see below)
AES67 (RJ-45)	Depending on CAT type of the cable	Via Ethernet connectors (RJ-45)

- ▶ If possible, use a balanced, analog signal connection (XLR, stereo jack) to prevent interference in the cable.

### Connecting analog signals to the loudspeaker

#### Connecting XLR or RCA cables

- ▶ Connect the left and right output of your analog audio source to the XLR input sockets of the respective loudspeaker.

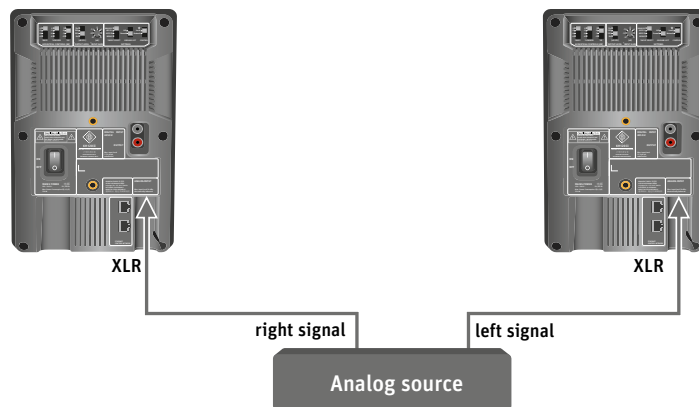

- ▶ Use an XLR adapter (not supplied) to connect unbalanced cables (e.g. RCA cables).
- ▶ Use this adapter directly at the source and connect the adapter via a properly wired balanced XLR cable to the loudspeaker. The connection of pin 3 to ground should be as close as possible to the source to maximize hum rejection on the cable.





▶ Use the following wiring if you want to make your own RCA-to-XLR cable:

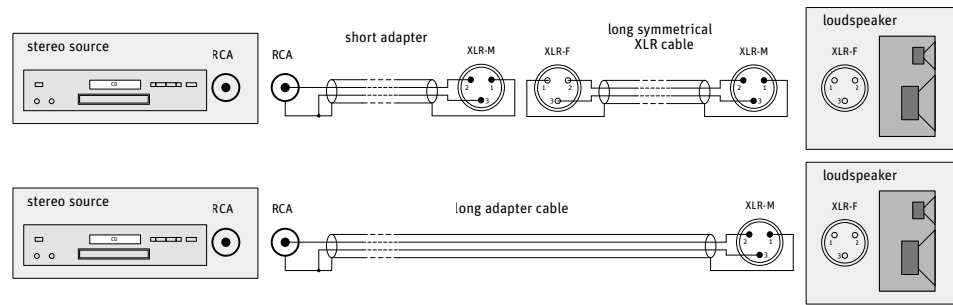

### Connecting digital AES3id and S/PDIF signals to the loudspeaker

**Connecting AES3 cables** ▶ Connect the digital AES3id or S/PDIF output signal of your audio source to the DIGITAL S/PDIF INPUT socket on the first loudspeaker (see figure below).

**i** The loudspeaker only supports non-encoded AES3 and S/PDIF signals. Encoded signals such as MP3, DTS or Dolby Digital are not supported. The cable connection must be unbalanced with a characteristic impedance of 75 Ω.

**i** Only one cable is needed for uncompressed AES3 and S/PDIF digital signals (single-wire mode). They contain two audio channels: “subframe A” and “subframe B.” Usually, the audio channels are:

Subframe A	Subframe B
Left	Right
Center	LFE
Surround left	Surround right
Back left	Back right

A clock input is not required because loudspeakers are not audio sources and the converters are clocked to a very stable internally generated clock source.

**i** If the signal source is based on internal digital signal processing, it is recommended that you choose a digital connection between the signal source and the loudspeaker. This eliminates the need for additional signal conversion from digital to analog in the source and from analog to digital in the loudspeaker. This also applies if you are connecting to an upstream DSP subwoofer (e.g. KH 750 DSP). This should be connected to the loudspeakers via its digital output.

Note that the supplied digital signal often has a maximum signal level, and that the level in the source is often not adjustable. Therefore, before making the digital connection, set the OUTPUT LEVEL switch on the loudspeaker to 94 dB SPL and the INPUT GAIN knob to -15 dB.

- ▶ Connect the DIGITAL S/PDIF OUTPUT socket on the first loudspeaker to the DIGITAL S/PDIF INPUT socket on the second loudspeaker.
- ▶ Set the INPUT SELECT switch on the left loudspeaker to S/PDIF L and the INPUT SELECT switch on the right loudspeaker to S/PDIF R. The CONTROL switch must be in the Local position.

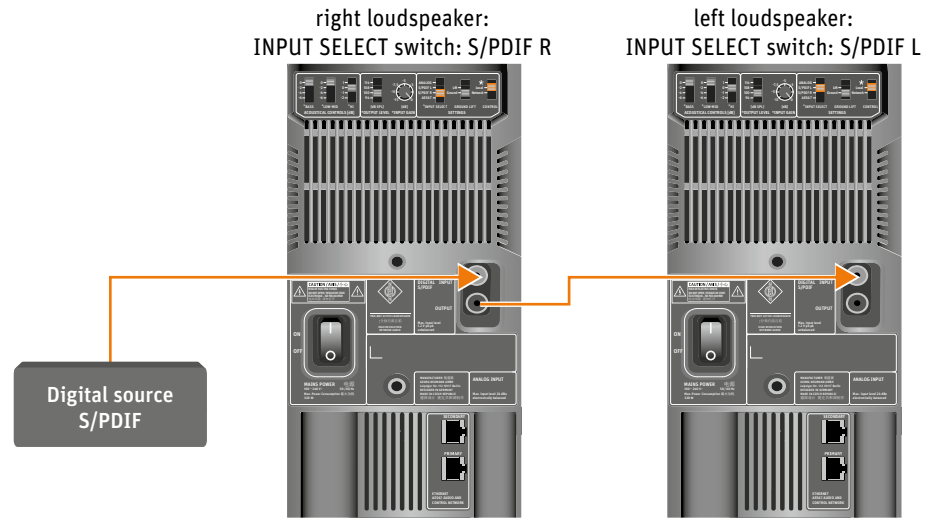

**i** The settings of the first loudspeaker in the signal chain are not looped through to the second loudspeaker. Each loudspeaker must be configured separately.

When using a daisy chain connection as shown here, the signal from the second loudspeaker is not delayed relative to the first loudspeaker.

The output of the final loudspeaker does not have need to be terminated with an additional 75 ohms. It is terminated internally.

**Connecting AES67 audio network cables**

**Connecting digital AES67 signals to the loudspeaker**

In order to use the AES67 digital audio network stream, please observe the chapter “Configuring AES67 network and audio settings” on page 20, which provides detailed information on the entire AES67 configuration and usage.

**Connecting a network cable for network control**

To use the extended functionality offered by the MA 1 – Automatic Monitor Alignment software, the loudspeaker must be connected via the PRIMARY socket to a standard network switch using a user supplied standard Ethernet cable (Cat 5 or better). The maximum length of the cable is 100 m.

Refer to the MA 1 – Automatic Monitor Alignment software for information about how to use loudspeakers in a network.

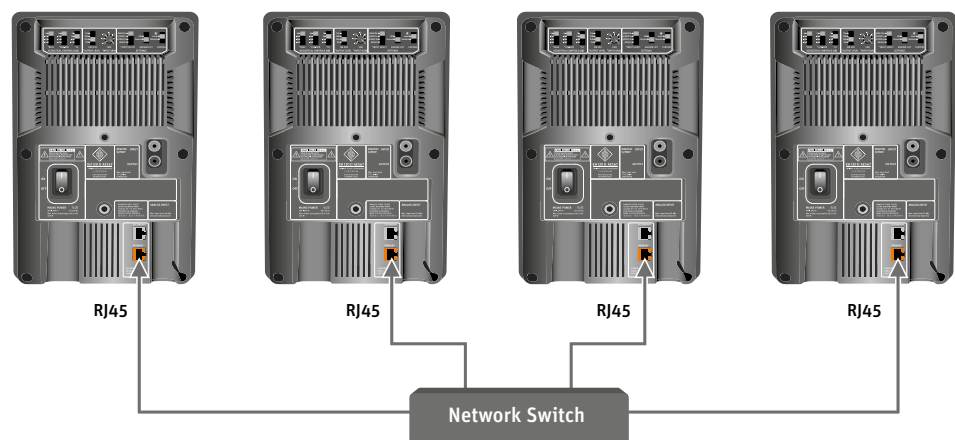

**i** This device supports Sennheiser Sound Control (SSC) based on TCP and IPv6. The static IPv6 address of the device can be determined with mDNS. For more information about SSC, see the Sennheiser website.

## Connecting/disconnecting the loudspeaker to/from the power supply system

To connect the loudspeaker to the power supply system:

- ▶ Make sure that the on/off switch is set to “0”.
- ▶ Connect the IEC connector on the supplied power cable to the power supply socket.

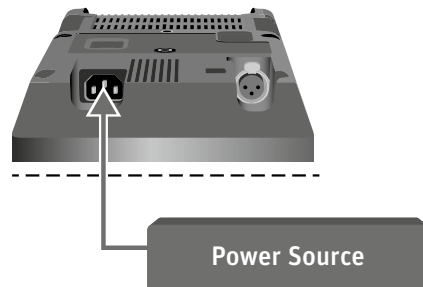

- ▶ Connect the wall plug on the power cable to a suitable wall outlet.

To completely disconnect the loudspeaker from the power supply system:

- ▶ Set the on/off switch to “0”.
- ▶ Pull the wall plug out of the wall outlet.

## Configuring and using the loudspeaker

### Switching the loudspeaker on/off

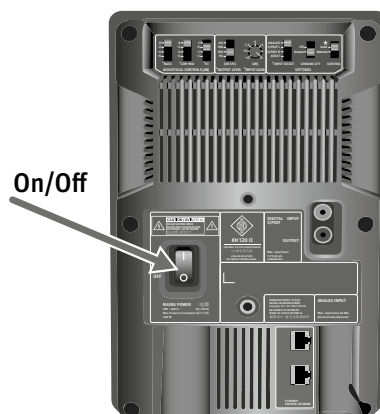

- ▶ Set the on/off switch to:

- “I” to switch on the loudspeaker. The Neumann logo lights up solid red while the DSP system boots up. The loudspeaker is ready for operation as soon as the light turns white (after approx. 5 seconds if the INPUT SELECT switch is in the ANALOG or S/PDIF position, after approx. 2.5 minutes if the INPUT SELECT switch is in the AES67 position). Using the software **MA 1 – Automatic Monitor Alignment** allows you to dim the logo or switch it off completely after the boot phase is complete.
- “OFF” to switch off the loudspeaker. The Neumann logo switches to red for a short moment and then goes off.

**i** Once it switches on, the loudspeaker remains muted (5 seconds if the INPUT SELECT switch is in the ANALOG or S/PDIF position, 2.5 minutes if the INPUT SELECT switch is in the AES67 position). This suppresses any noise that would be generated by connected devices that are switched on at the same time. Conversely, switching off the loudspeaker immediately mutes the audio.



## Functionality of the Neumann logo

Action	Logo indication
<b>Firmware activities</b>	
Loudspeaker is booting up, muted	Solid red: 5 seconds for switch setting INPUT SELECT = ANALOG or S/PDIF 2.5 minutes for switch setting INPUT SELECT = AES67
Loudspeaker is shutting down, muted	Brief red light
Loudspeaker boot up error	Red flashing (fast)
Loudspeaker firmware is being updated	Solid pink
Loudspeaker resetting to factory default settings	Pink flashing (very fast)
<b>Normal operation</b>	
Loudspeaker switched on and ready for operation (can be dimmed using MA 1 – Automatic Monitor Alignment software)	Solid white
MA 1 – Automatic Monitor Alignment software is saving the changes to the loudspeaker	Solid white
<b>Protection and standby</b>	
Peak limiter active	Brief red light in time with the pulse peaks
Thermolimiter active	Solid red as long as level reduction is active
Overload protection	Solid red as long as the loudspeaker is muted to prevent overheating
Other protection system is activated (takes priority over other indications)	Red
<b>Calibration with the MA 1 – Automatic Monitor Alignment software</b>	
Identifying the loudspeaker	Flashing pink (2 Hz)
Loudspeaker is selected	Solid white



## Switches on the SETTINGS panel

The three switches on the SETTINGS panel control different functions.

### CONTROL

The CONTROL switch toggles between backplate mode and network mode.

#### Local – backplate mode

If the CONTROL switch is in the **Local** position, the loudspeaker will not respond to network commands. The loudspeaker can only be controlled using the controls on the backplate.

#### Network – network mode

If the CONTROL switch is in the **Network** position, the loudspeaker responds to the network commands from the **MA 1 – Automatic Monitor Alignment** software. The controls marked \* on the back of the loudspeaker are ignored.

If the CONTROL switch is set to **Network** but there is no network connection and the **MA 1 – Automatic Monitor Alignment** software is not active, the most recent network configuration is used.

If you have configured any settings via the **MA 1 – Automatic Monitor Alignment** software and you remove the network cable, the current settings will stay active.

By switching from network control to local control, you can easily switch between a configuration set in the **MA 1 – Automatic Monitor Alignment** software and settings made directly on the loudspeaker.

This is useful if you want to temporarily use the loudspeaker in a location other than the studio environment you configured.

The loudspeaker does not lose its settings even when you disconnect it from the network or the power supply.

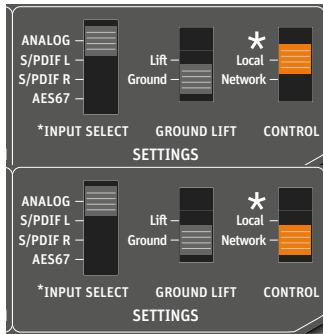

### INPUT SELECT

The INPUT SELECT switch toggles between the analog input and the digital inputs.

Set the INPUT SELECT switch to **ANALOG** if you intend to feed an analog signal into the XLR socket labeled **ANALOG INPUT**.

Set the INPUT SELECT switch to **S/PDIF L** or **S/PDIF R** if you intend to feed a digital AES3id or S/PDIF signal into the RCA socket labeled **DIGITAL S/PDIF INPUT**.

Set the INPUT SELECT switch on the left loudspeaker to **S/PDIF L** and the right speaker's INPUT SELECT switch to **S/PDIF R** for normal stereo mode.

If the loudspeakers are used as surround speakers in larger systems, the channels must be configured based on how they are assigned in the source. In this case, channel A (digital subframe A) corresponds to the left channel and channel B (digital subframe B) corresponds to the right channel.

Set the INPUT SELECT switch to **AES67** if you want to feed in a digital AES67 signal via the Ethernet interface. Only the first channel of the AES67 audio stream is played.

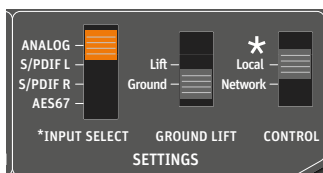

Switch position	Meaning
ANALOG	XLR socket ANALOG INPUT is active
S/PDIF L	Digital subframe A, RCA socket DIGITAL S/PDIF INPUT is active
S/PDIF R	Digital subframe B, RCA socket DIGITAL S/PDIF INPUT is active
AES67	AES67 audio network stream, RJ-45 sockets PRIMARY and SECONDARY are active



### GROUND LIFT

The GROUND LIFT switch internally separates pin 1 of the XLR input socket from the electronics chassis ground.

If there is humming or buzzing noise coming from the loudspeaker, first search for the cause of the noise:

- Disconnect all input cables from the loudspeaker.

If the noise goes away, it is probably coming from the audio source or source cabling. It might be possible to eliminate the noise by disconnecting the ground from the input signals (activating ground lift).

To activate the ground lift:

- Reconnect the signal cables and set the GROUND LIFT switch to **Lift**.

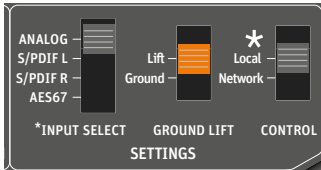

 For safety reasons, the electronics chassis ground is always connected to the ground contact of the power supply. Never disconnect the ground contact of the power cable from ground.

## Resetting the loudspeaker settings

You can use the **MA 1 – Automatic Monitor Alignment** software to configure the loudspeaker beyond what is available on the backplate.

To reset these internal loudspeaker parameters to the factory settings:

- Set the INPUT SELECT switch to ANALOG, S/PDIF L or S/PDIF R.
- Switch on the loudspeaker.
- While the logo is flashing during the boot up phase, move the CONTROL switch up and down repeatedly. Continue until the logo turns solid white for a few seconds. The logo begins quickly flashing red for a few seconds before turning white again.

## Firmware update

Firmware updates are done via the **MA 1 – Automatic Monitor Alignment** software. When you open the software, it scans the network for loudspeakers and checks if the firmware is up to date. If a firmware update is required, you will be notified. Follow the instructions shown on screen.

It takes approximately 10 seconds per loudspeaker to update the loudspeaker firmware.

The AES67 firmware update may take up to 30 minutes.

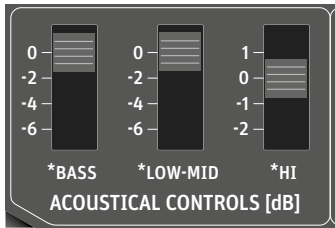

## Adapting loudspeakers to the environment using the switches on the backplate

When the switches BASS, LOW-MID and HI on the ACOUSTICAL CONTROLS panel are set to 0, the loudspeaker is designed to have a flat frequency response in anechoic conditions.

The frequency response will change in your monitoring environment. The loudspeaker's frequency response will also change based on its position in the room. The same loudspeaker installed in different positions in the same room may require different acoustical control settings. In a symmetrical installation, left/right pairs (front or back) will probably have the same acoustical settings.

- ▶ Before using your loudspeaker system for the first time, align the frequency response of the loudspeakers in the room in order to obtain the desired transfer behavior.
- ▶ Repeat the above step if you change the physical conditions in your studio.
- ▶ At your listening position, determine the frequency response of each loudspeaker.

**i** These switches are not intended for adjusting the sound to your preferences during playback. They are used to adapt the loudspeaker to the acoustical conditions of the room and the position in the room to provide as neutral a response as possible.

Switch	Function	Possible settings
BASS	Compensates for acoustical loading in the low frequency range due to nearby large solid boundaries (e.g. walls).	0, -2, -4, -6 dB
LOW-MID	Compensates for acoustical loading in the low-mid frequency range due to large, reflecting objects (e.g. mixing consoles, tables or screens) in the vicinity of the loudspeaker.	0, -2, -4, -6 dB
HI	Compensates for insufficient or excessive high-frequency damping in the room.	+1, 0, -1, -2 dB

The following settings can be used as a starting point for further adjustment:

Loudspeaker position	Switch		
	BASS	LOW-MID	HI
In a corner	-6 dB	-2 dB	—
Next to an acoustically solid wall (e.g. brick, concrete)	-4 dB	—	—
Next to an acoustically soft wall (e.g. drywall)	-2 dB	—	—
Free standing in an untreated room	-2 dB	—	-1 dB
Free standing in a well-treated room	—	—	—
In a small room with strong side wall reflections	-4 dB	0 dB	—
Near a small desktop or small reflecting surface*	—	-2 dB	—
Near a large desktop or large reflecting surface*	—	-4 dB	—

\*Use these settings in addition to one of the top settings.

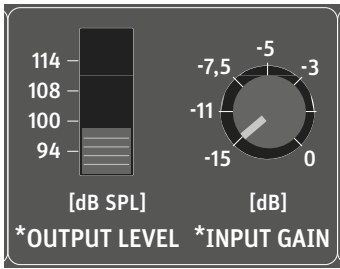

### Adjusting the acoustical level

- ▶ On your loudspeakers, set the OUTPUT LEVEL switch to 94 dB SPL and the INPUT GAIN knob to -15 dB.
- ▶ Play a broadband pink noise test signal that is set to -18 dBFS (Europe) or -20 dBFS (USA) on the mixing console's output level meters.
- ▶ Measure the sound pressure level at the listening position. Use a sound level meter with the following settings:
  - "C" weighted
  - Slow integration time
- ▶ Set the OUTPUT LEVEL switch and INPUT GAIN control of your loudspeakers so that the desired acoustic level is obtained.

Recommended sound pressure levels:

Application	Sound pressure level
Film	85 dB(C)
Broadcast	79 to 83 dB(C)
Music	No defined reference levels

If the Neumann logo flashes red, the loudspeaker's protection system has been activated. To avoid this and achieve the desired output level, use larger loudspeakers or add a bass managed subwoofer to the system.

Examples of sound pressure levels as a function of the loudspeaker's input and output level:

Input signal dBu	0 (0.775 V)	0 (0.775 V)	+4 (1.23 V)	-20 (77.5 mV)
INPUT GAIN knob dB	0	-15	-4	-15
OUTPUT LEVEL switch dB SPL	100	100	94	114
Sound pressure level dB SPL in 1 m	100	85	94	79

**i** If your signal source is not used as a reference for the listening level, make sure that the level of the source is higher and the level on the loudspeakers is lower. This reduces the self-noise from the source and any extraneous signals in the input line.





## Configuring standby mode

The loudspeaker has an automatic standby function that is dependent on the input signal. It switches the loudspeaker into power saving mode when it hasn't been used for a period of time. The standby function is only enabled when the INPUT SELECT switch is in the ANALOG, S/PDIF L or S/PDIF R position. When the switch is in the AES67 position, the standby function is disabled.

Standby means that the network interface, signal processing circuitry and power amplifiers are all powered down. Standby mode is automatically deactivated when a sufficiently large audio signal is detected at the input. The time taken to resume normal operation and hear sound is 5 seconds.

When the INPUT SELECT switch is in the ANALOG position, the loudspeaker switches to standby mode after 90 minutes without an input signal or with only a very low input level.

For the standby function to be activated, the incoming signal must not cause the loudspeaker's output level to exceed an internally specified threshold for the specified standby time. This therefore depends on both the amplitude of the input signal and the level setting on the loudspeaker itself. The level threshold is 20 dB SPL at a distance of 1 m in free field conditions.

Even if there is no input signal, however, interference and crosstalk in the signal source or input line can cause the loudspeaker to wake up or prevent the loudspeaker from switching to standby mode in the first place.

If the INPUT SELECT switch is in the positions S/PDIF L or S/PDIF R, the loudspeaker switches to standby mode after 90 minutes when there is no digital clock signal or the digital input signal is muted. In these modes, the loudspeaker wakes up when the digital signal reappears.

Standby mode will remain active as long as the sampling rate of the applied S/PDIF signal does not change.

When switching to standby mode, a slight pop may be heard.

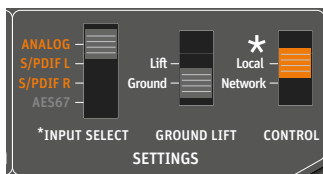

### Standby in backplate mode

- Set the CONTROL switch to Local.

The idle time for standby mode is 90 minutes.

The output level depends on the positions of the OUTPUT LEVEL switch and the INPUT GAIN knob on the back of the loudspeaker. Set them as required for your setup.

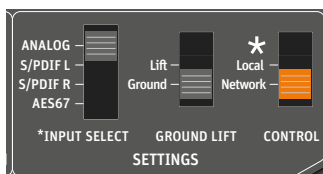

### Standby in network mode

- Set the CONTROL switch to Network.

You can disable automatic standby mode using the MA 1 – Automatic Monitor Alignment software.



## Customizing standby behavior

### Standby is too sensitive

If standby is too sensitive, the loudspeaker will not enter standby mode when it is supposed to, or it will wake up from standby mode when it is not supposed to.

Possible reasons:

The source may contain extraneous noise or noise peaks that wake the loudspeaker up or prevent it from going into standby. This can also cause loudspeakers with the same settings to behave differently.

You can determine if extraneous noise or noise peaks are responsible for the behavior as follows:

- ▶ Set the CONTROL switch to **Local**.
- ▶ Set the OUTPUT LEVEL switch to 114 dB to listen for possible extraneous noise.
- ▶ Listen carefully to identify noise peaks.
- ▶ Alternatively, you can record the loudspeaker output signal with a microphone and analyze the recording.
- ▶ Try to find out whether switching other devices in the house on or off has an effect (e.g. refrigerator or similar).

You can check that the standby feature is working correctly by connecting a short XLR cable to the loudspeaker input without connecting a device to the other end of the cable.

### Backplate mode:

- ▶ In backplate mode, set the OUTPUT LEVEL switch to 100 dB.  
The loudspeaker should enter standby mode after 90 minutes.

### Network mode:

- ▶ In network mode, use the **MA 1 – Automatic Monitor Alignment** software to set the standby threshold to 30 dB and the standby time to any value.  
The speaker should enter standby mode after the time you set.

 Since the loudspeaker continuously monitors the input signal, peaks that come from the source or are induced in the cable can also prevent the loudspeaker from switching to standby mode. Make sure that there are no peaks coming from the source or induced in the cable that can wake up the loudspeaker.



### Standby is not sensitive enough

If standby is not sensitive enough, the loudspeaker goes into standby mode when it is not supposed to, or does not wake up from standby mode when it is supposed to.

Possible reasons:

The standby threshold is above the signal level. If the input and output levels of the loudspeaker are set very low, but the source has a high level, this can result in a very quiet output signal.

#### Backplate mode:

- ▶ In backplate mode, raise the source output level or the input and output levels of the loudspeaker in order to raise the sound pressure level above the standby threshold.

#### Network mode:

- ▶ In network mode, raise the source output level or the input and output levels of the loudspeaker in order to raise the sound pressure level above the standby threshold.

In general, you should set the loudspeaker level as low as possible (e.g., the INPUT GAIN knob to 0, the OUTPUT LEVEL switch to 94 or 100 dB SPL) and the level of your source as high as possible to obtain the best possible signal-to-noise ratio and minimize induced extraneous noise.

Ideally, the source should be connected to the loudspeaker using a balanced XLR cable (XLR to XLR or jack to XLR). If only an unbalanced source is available, you should connect it as shown in the following figures.

### Headphone output (TV or hi-fi system): miniature jack (3.5 mm) or jack (6.3 mm):

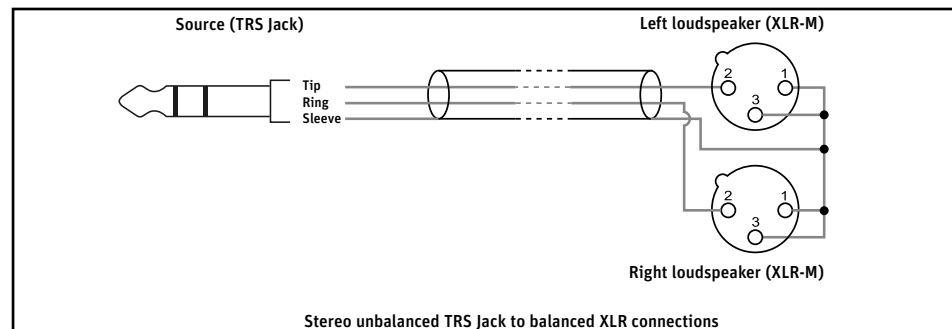

### RCA line output from a television (if the output level is adjustable) or RCA output (pre-amp) from an AV receiver. One cable is required per speaker:

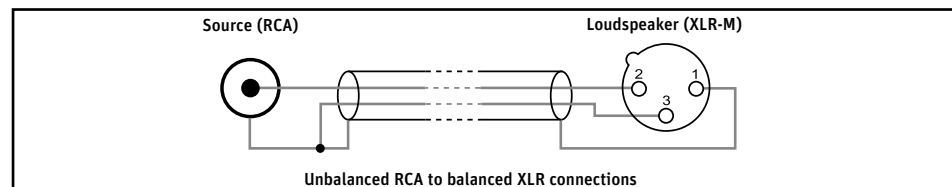

## Configuring AES67 network and audio settings

### Initial setup

Before using the loudspeaker in your network, we recommend checking the AES67 network settings and following this procedure for the initial setup of the AES67 interface.

The initial loudspeaker configuration and setup is divided into the following two procedures:

- The operational audio control mode: see the chapter “Selecting the control mode and audio input”.
- AES67-compatible network interface: see the chapter “Setting up the AES67 network interface” on page 21.

▶ Follow the steps described in these chapters in order to configure your AES67 network.

### Selecting the control mode and audio input

The loudspeaker offers two different control modes to perform the audio configuration.

- In backplate mode (CONTROL = Local), all settings are performed via the controls on the loudspeaker’s backplate.
- In network mode (CONTROL = Network), the controls on the backplate marked with “\*” are disabled. Settings can only be made using the **MA 1 – Automatic Monitor Alignment** software.

 For more information on the two loudspeaker control modes, refer to the chapter “CONTROL” on page 13.

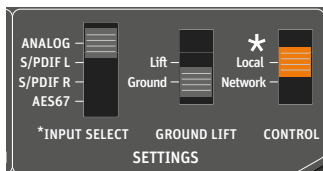

#### Setting the control mode for initial setup

- ▶ Set the CONTROL switch to Local.
- ▶ Keep it in this position during the initial AES67 setup.

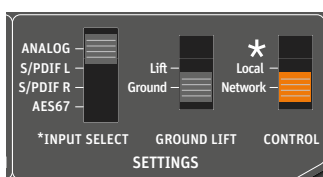

Once the initial setup is done:

- ▶ Set the CONTROL switch to Network in order to use the **MA 1 – Automatic Monitor Alignment** software for your individual room calibration.

 For more information on the **MA 1 – Automatic Monitor Alignment** software, refer to: <https://en-de.neumann.com/ma-1>

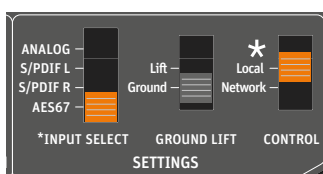

#### Setting the audio input mode for initial setup

- ▶ Set the INPUT SELECT switch to AES67 in order to activate the AES67 audio and network ports.

 For more information on selecting the audio input signals, refer to the chapter “INPUT SELECT” on page 13.



## Setting up the AES67 network interface

The loudspeaker features a fully redundant network interface according to ST 2022-7 and can be operated in redundant or non-redundant mode. The factory default setting is non-redundant.

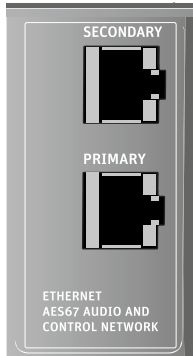

The network interface configuration can be accessed via the built-in web interface of the AES67 port. The AES67 configuration can be accessed with any web browser from a PC, Mac or any other computer.

The two RJ-45 network sockets of the interface can be operated in non-redundant mode (switched mode) or in redundant mode according to ST 2022-7.

**Redundant mode:** both PRIMARY and SECONDARY sockets have the same signal for setting up two completely redundant streams in your audio network infrastructure.

**Non-redundant mode (switched mode):** the SECONDARY socket can be used for daisy-chaining the signal to the PRIMARY socket of another loudspeaker. In that mode the PRIMARY socket of the first loudspeaker needs to be used for network control.

### Default IP addresses of the loudspeaker

The loudspeaker's network interface has three IP addresses.

#### Primary address in non-redundant operation (eth0)

The non-redundant primary interface (eth0) is assigned and only used in non-redundant mode. This port is used by the AES67 audio and the MA 1 – Automatic Monitor Alignment software (PC/Mac).

The IP address is automatically configured via DHCP or link-local.

Note: when changing the IP settings, be sure to define this IP address in a different subnet compared to the primary IP address in redundant mode (see below), even when you are using the loudspeaker in redundant mode.

#### Primary address in redundant operation (eth1.10)

The redundant primary interface (eth1.10) is assigned and used in redundant mode. This redundant primary port is used by the AES67 primary audio and the MA 1 – Automatic Monitor Alignment software (PC/Mac).

The factory default is:

IP:	192.168.10.100
Mask:	255.255.255.0

Note: be sure to define this IP address in a different subnet compared to the primary IP address in non-redundant mode (see above), even when you are using the loudspeaker in non-redundant mode.

#### Secondary address in redundant operation (eth2.20)

The redundant secondary interface (eth2.20) is assigned and used in redundant mode.

This redundant secondary port is used by the AES67 secondary audio.

The factory default is:

IP:	192.168.20.100
Mask:	255.255.255.0

NOTE: ensure that these three IP addresses are not in the same subnet as any of the other two IP addresses.

### Accessing the network interface via a web browser

To access the loudspeaker's web interface for the first time:

- Connect the loudspeaker directly to your PC/Mac via the PRIMARY network socket.



For the initial access no network switch is required and the SECONDARY network socket needs to be unconnected.

- ▶ Make sure that the loudspeaker is switched on.
- ▶ Download the MT Discovery app from the product page for your Neumann AES67 loudspeaker and install it.

When you open the MT Discovery app, you will see a list of the AES67 devices found in the network. Your AES67 loudspeaker (or its Ross chip set) is now displayed under “Neumann Studio Monitors.”

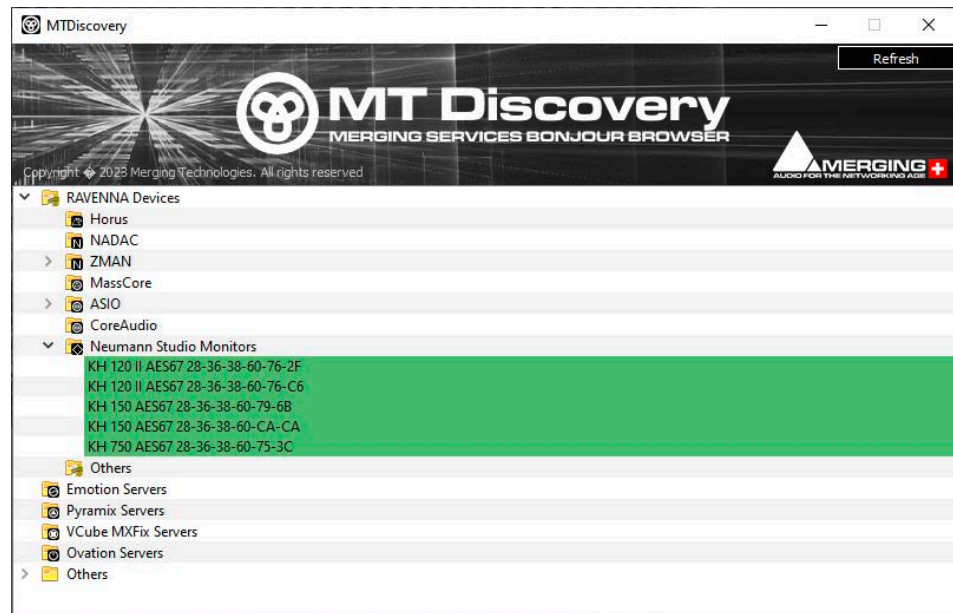

- ▶ Move the cursor to this row in the list to display the device’s IP address.

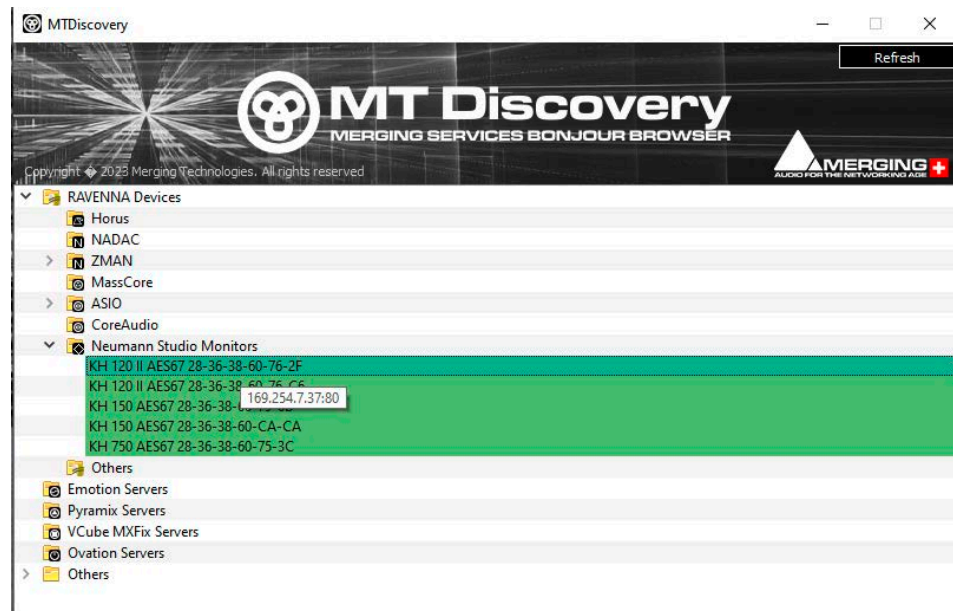

- ▶ On your PC or Mac, either set the IP address to DHCP/Automatic, or manually set it to the same address range shown in MT Discovery.  
For a manual configuration, the subnet mask is 255.255.255.0 in most cases.
- ▶ Make sure that the computer’s IP address is not identical to the loudspeaker’s IP address.
- ▶ Open a web browser (Google Chrome is recommended) and enter the loudspeaker’s IP address as displayed in MT Discovery in the address line of the browser.  
The home page of the web interface will open and display information about the connected loudspeaker.

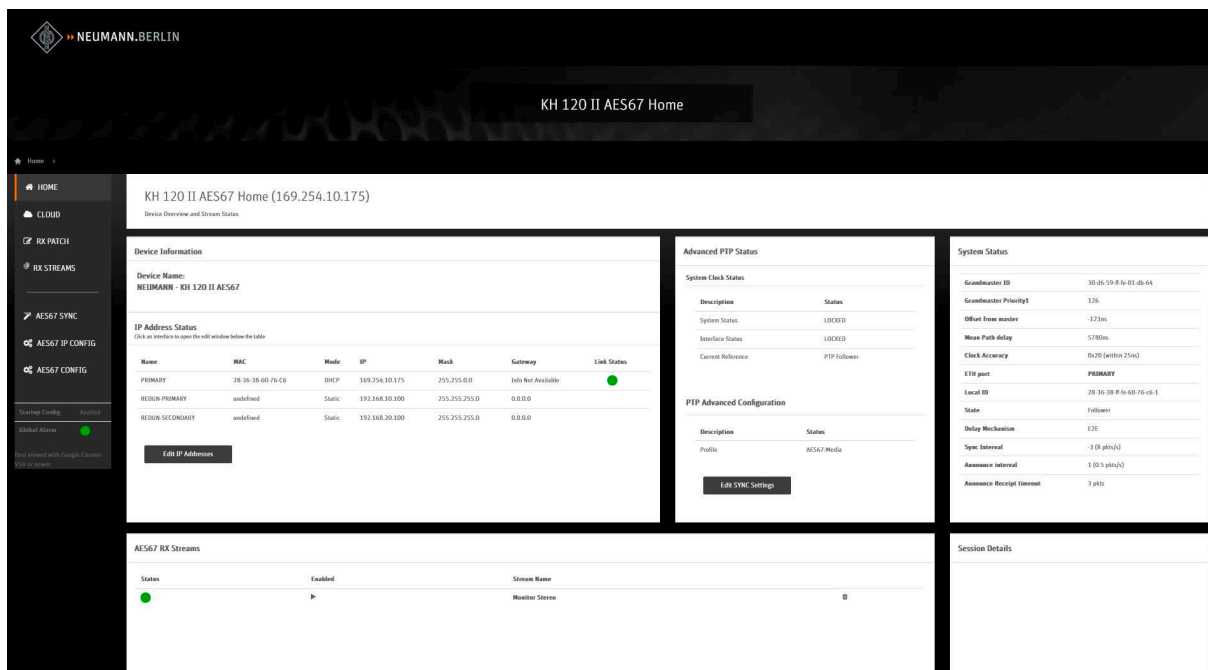

The web interface offers the following menu items for configuring the AES67 audio network:

Menu item	Configuration
HOME	Overview of the essential operating parameters and status information.
CLOUD	Summary of all discovered Ravenna devices in the network. You can also reach the web interface of each of the discovered devices from here.
RX PATCH	Routing matrix for receiving audio signals from an AES67 source.
RX STREAMS	Advanced routing matrix.
AES67 SYNC	Overview and configuration of the current active PTP master, the media clock synchronization status and details of the active PTP profile.
AES67 IP CONFIG	Overview and configuration of the active IP addresses, subnet masks and control gateway.
AES67 CONFIG	Overview and configuration of network modes and connection management settings.

 If you choose to change the IP addresses and reboot the loudspeaker, you might need to re-adjust the IP settings of your PC/Mac according to the new primary addresses in order to access the web interface for future configuration.

### Setting up IP addresses and network redundancy

Depending on the mode you will be using (redundant/non-redundant) and your existing network configuration you can change the IP addresses of the loudspeaker according to your requirements.

The first three necessary steps in the initial configuration are

- setting the IP addresses
- setting the redundancy mode
- saving the settings as default

After that the loudspeaker needs to be rebooted in order to perform any further configuration.



To change the IP addresses:

- ▶ In the web interface, navigate to the **AES67 IP CONFIG** menu item in the menu on the left. The IP address configuration screen will be displayed.

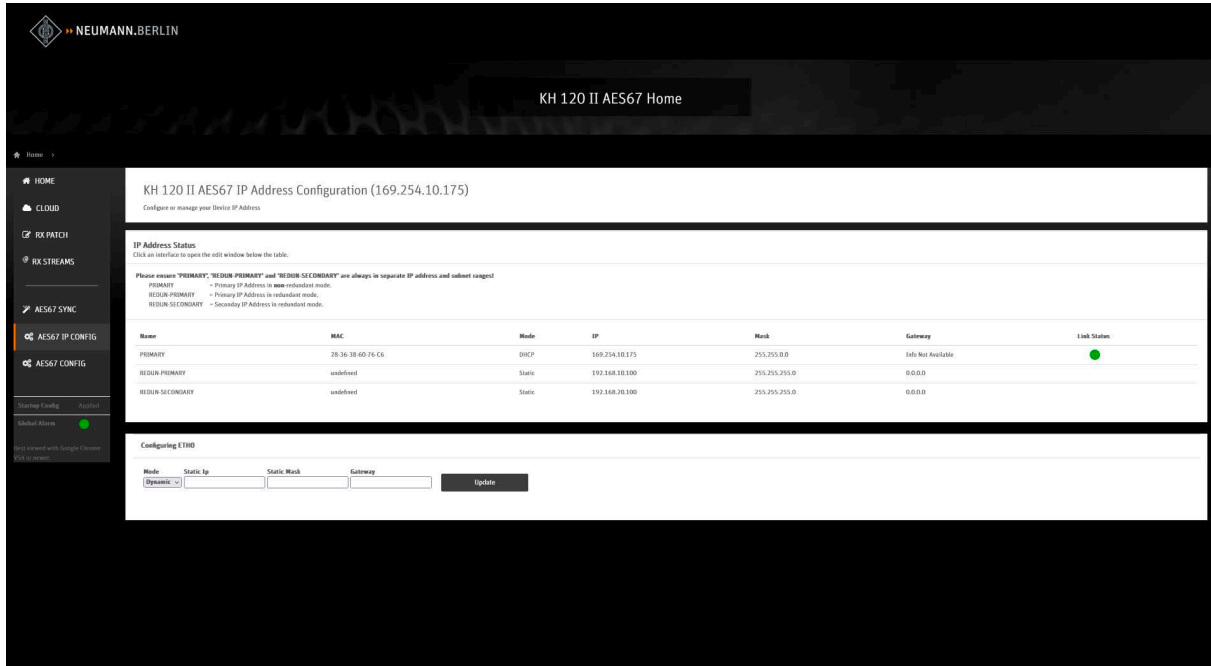

To set up IP addresses for non-redundant operation (switched mode):

- ▶ Click on the first line (eth0) of the IP address page.

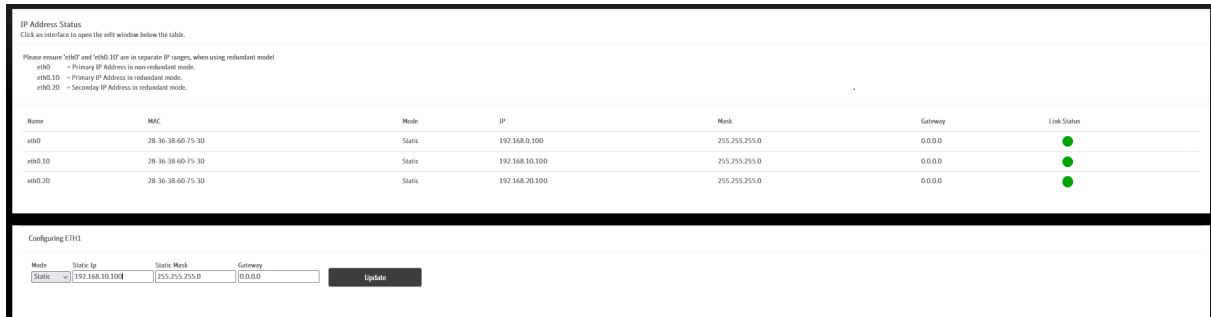

- ▶ Edit the IP address, IP mask and gateway according to your requirements.
- ▶ Click **Apply** to save the changes.

To set up IP addresses for redundant mode:

- ▶ Click on each line for each socket (eth1.10 and eth2.20) of the IP Address page.
- ▶ Edit the IP address, IP mask and gateway according to your requirements.
- ▶ Set the IP addresses for eth0 and eth1.10 in separate IP ranges for redundant operation.
- ▶ Click **Apply** to save the changes.

To set up the network redundancy mode:

- ▶ In the web interface, navigate to the **AES67 CONFIG** menu item in the menu on the left. The AES67 configuration screen will be displayed.



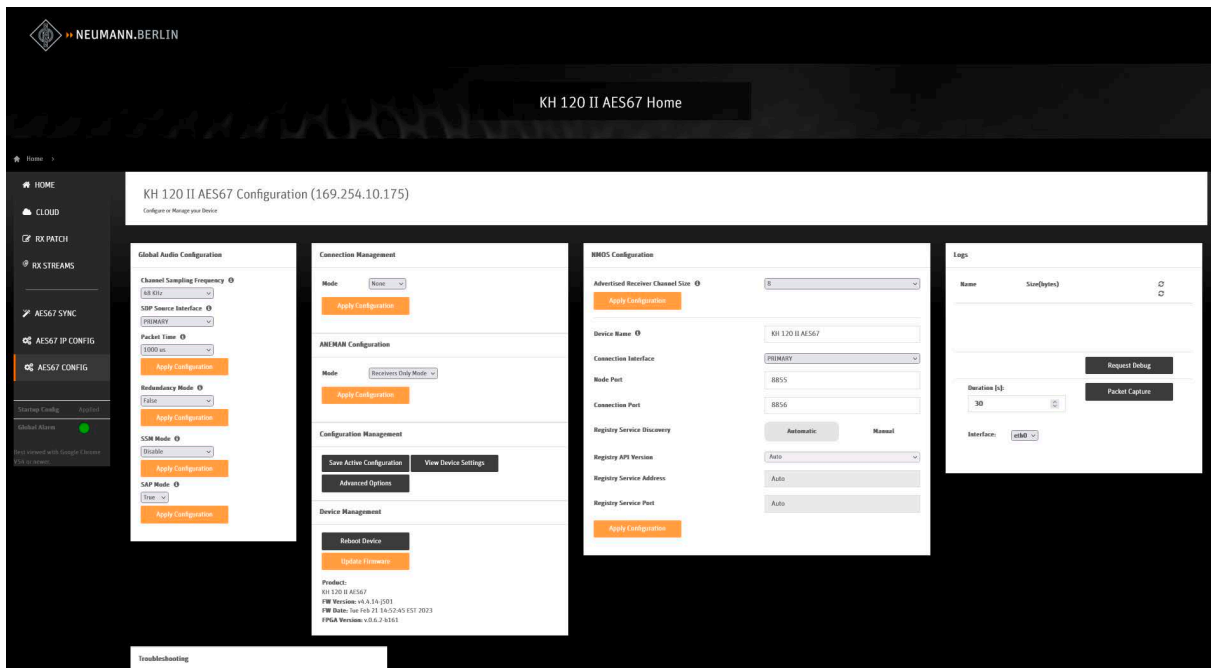

- ▶ Select the desired redundancy mode from the dropdown menu in the **Settings** tab on the left.  
The default redundancy mode is non-redundant.
- ▶ Click **Update Redun Mode** to save your changes.

### Saving the current settings as default

In order to save the current configuration to the start-up configuration:

- ▶ Navigate to the **AES67 CONFIG** menu item.
- ▶ Click **Save Active Configuration**.

### Rebooting the loudspeaker after setting the IP addresses and redundancy mode

After setting the IP addresses and the redundancy mode, the loudspeaker needs to be rebooted before performing any further configuration.

- ▶ Navigate to the **AES67 CONFIG** menu item.
- ▶ Click **Reboot Device**.

 After the reboot, the settings configured as mentioned above will become valid. You might need to adjust the IP settings of your PC/Mac according to the new primary addresses in order to access the web interface.



## Setting up the PTP media clock

After the initial setup of the AES67 interface and rebooting the loudspeaker, you can set up the PTP media clock.

### Setting up the PTP media clock synchronization

To set up the PTP media clock:

- ▶ Open the web interface of the KH 750 AES67.
- ▶ Navigate to the **AES67 SYNC** menu item in the menu on the left.

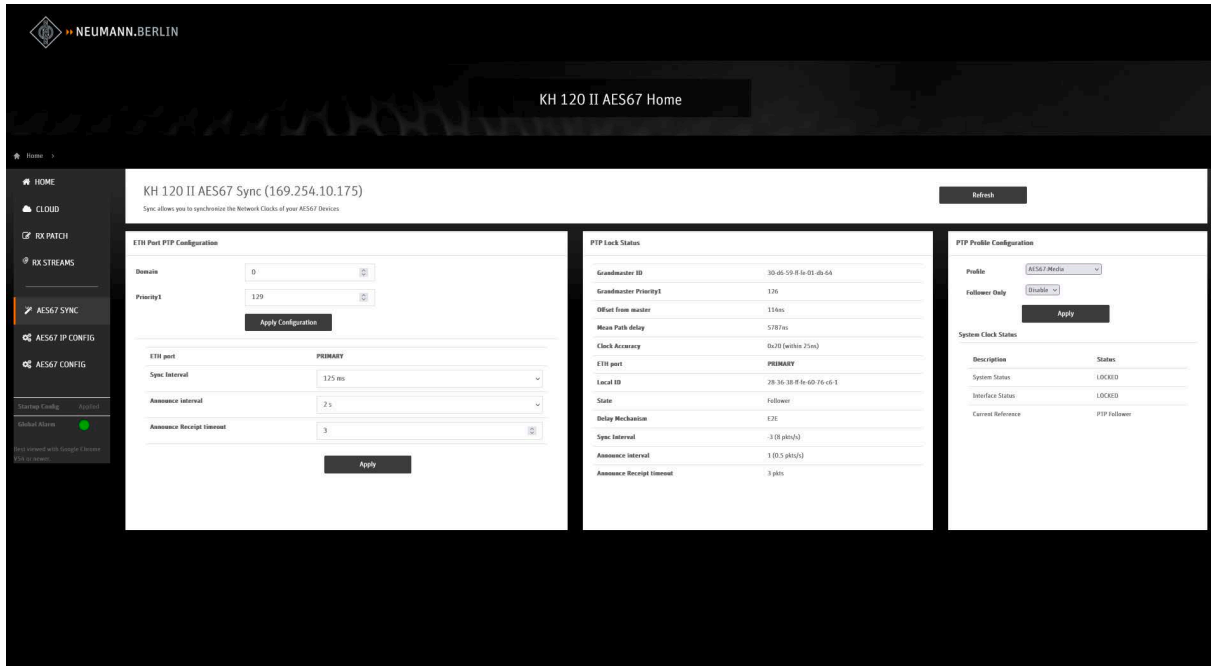

- ▶ Set up the PTP sync according to your system settings.

The available predefined PTP profiles are:

AES67:Media Profile	PTP profile for AES67 audio-only networks
IEEE1588v2:Default	PTP profile used for time-sensitive networks such as streaming applications
SMPTTE:2059-2	PTP profile for ST 2110 video and audio networks

 We recommend using the AES67:Media Profile (factory default) for audio-only networks.

### Configuring the PTP media clock profile

Individual parameters and settings of the PTP media clock profile can be edited and adopted to the individual network PTP clock settings. We recommend using the default settings of these parameters.

The individual parameters are:

- Media Clock Domain
- Media Clock Priority of the KH 750 AES67
  - Default value: 127
  - Min. value is 0 for PTP slave-only devices
  - Max. value is 255 for PTP clock master (not recommended)
- Sync Interval



- Announce Interval
- Announce Receipt Timeout

#### **Saving the current settings as default**

In order to save the current configuration to the start-up configuration:

- ▶ Navigate to the **AES67 CONFIG** menu item.
- ▶ Click **Save Active Configuration**.

#### **Rebooting the subwoofer**

After setting up the PTP media clock, the loudspeaker needs to be rebooted before performing any further configuration.

- ▶ Navigate to the **AES67 CONFIG** menu item.
- ▶ Click **Reboot Device**.



## Setting up the connection management mode

The loudspeaker has two connection management modes: ANEMAN (Ravenna) and NMOS protocol. The factory default is ANEMAN. Both protocols can also be disabled. Please note that ANEMAN and NMOS cannot be used simultaneously.

Changing the connection management mode requires you to reboot the loudspeaker.

### Setting up the ANEMAN/Ravenna connection management

To select the **ANEMAN** connection management mode:

- ▶ Navigate to the **AES67 CONFIG** menu item.
- ▶ Select **ANEMAN** from the **Mode** dropdown on the **Connection Management** tab.
- ▶ Select **Receivers Only Mode** from the **Mode** dropdown on the **ANEMAN Configuration** tab.
- ▶ Click **Apply Configuration**.

### Saving the current settings as default

In order to save the current configuration to the start-up configuration:

- ▶ Navigate to the **AES67 CONFIG** menu item.
- ▶ Click **Save Active Configuration**.

### Rebooting the loudspeaker

After setting up the ANEMAN connection management mode, the loudspeaker needs to be rebooted before performing any further configuration.

- ▶ Navigate to the **AES67 CONFIG** menu item.
- ▶ Click **Reboot Device**.

### Setting up NMOS connection management

The loudspeaker supports connection management via the NMOS protocol. It features AMWA IS-04 NMOS Discovery and Registration as well as AMWA IS-05 NMOS Device Connection Management:

- 8855 for IS-04: "node\_port": 8855
- 8856 for IS-05 : "connection\_port": 8856

The NMOS API can be accessed via:

- 192.168.10.100:8855/x-nmos/node/v1.3/self/
- 192.168.10.100:8856/x-nmos/node/v1.3/self/

To select the NMOS connection management mode:

- ▶ Navigate to the **AES67 CONFIG** menu item.
- ▶ Select **NMOS** from the **Mode** dropdown on the **Connection Management** tab.
- ▶ Configure any other settings relevant for your network environment.
- ▶ Click **Apply Configuration**.

When selecting NMOS, make sure that an RDS NMOS registration server is available.

It is possible to define one of the three network ports as the gateway for NMOS control (RDS) in larger networks.

- ▶ Navigate to the **AES67 IP CONFIG** menu item.
- ▶ Define the gateway for the desired port.
- ▶ Click **Apply**.



### **Saving the current settings as default**

In order to save the current configuration to the start-up configuration:

- ▶ Navigate to the **AES67 CONFIG** menu item.
- ▶ Click **Save Active Configuration**.

### **Rebooting the loudspeaker**

After setting up the ANEMAN connection management mode, the loudspeaker needs to be rebooted before performing any further configuration.

- ▶ Navigate to the **AES67 CONFIG** menu item.
- ▶ Click **Reboot Device**.



## Routing digital AES67 audio signals to the loudspeaker

### Setting up a stereo monitoring system

The following example is a possible way to set up a stereo monitoring system using two KH 150 AES67 loudspeakers and one KH 750 AES67 subwoofer. Your PC will require an AES67 ASIO driver and an AES67 audio interface.

This example describes the procedure for AES67/Ravenna connection management using the web interface of the KH 150 AES 67 and KH 750 AES67 as well as the ANEMAN Network Controller Software by Merging Technologies.

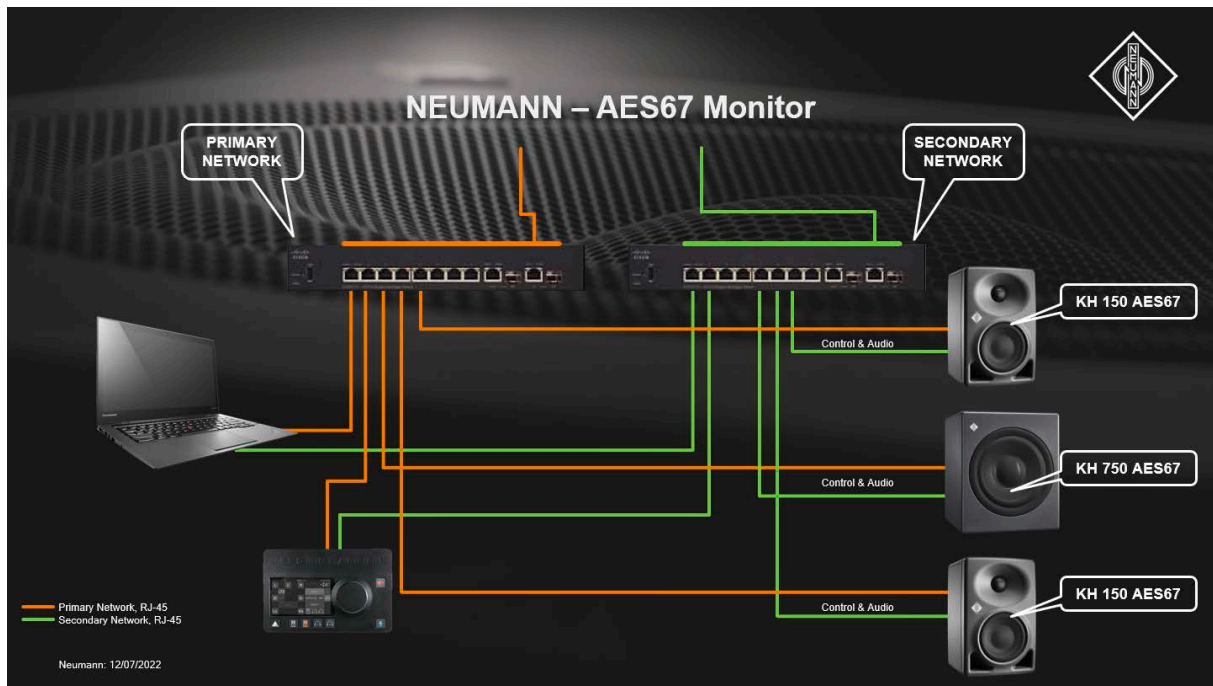

- 1 PC with two network ports
- 2 Cisco SG300-08 network switches
- 1 Merging Technologies Anubis Pro monitor controller
- 1 KH 750 AES67 – connected to both networks
- 2 KH 150 AES67 – connected to both networks



## Routing with RX PATCH

To establish a connection:

- ▶ Open the loudspeaker's web interface.
- ▶ Navigate to the **RX PATCH** menu item in the menu on the left. The top left will show all existing AES67 audio sources (streams) in your network.

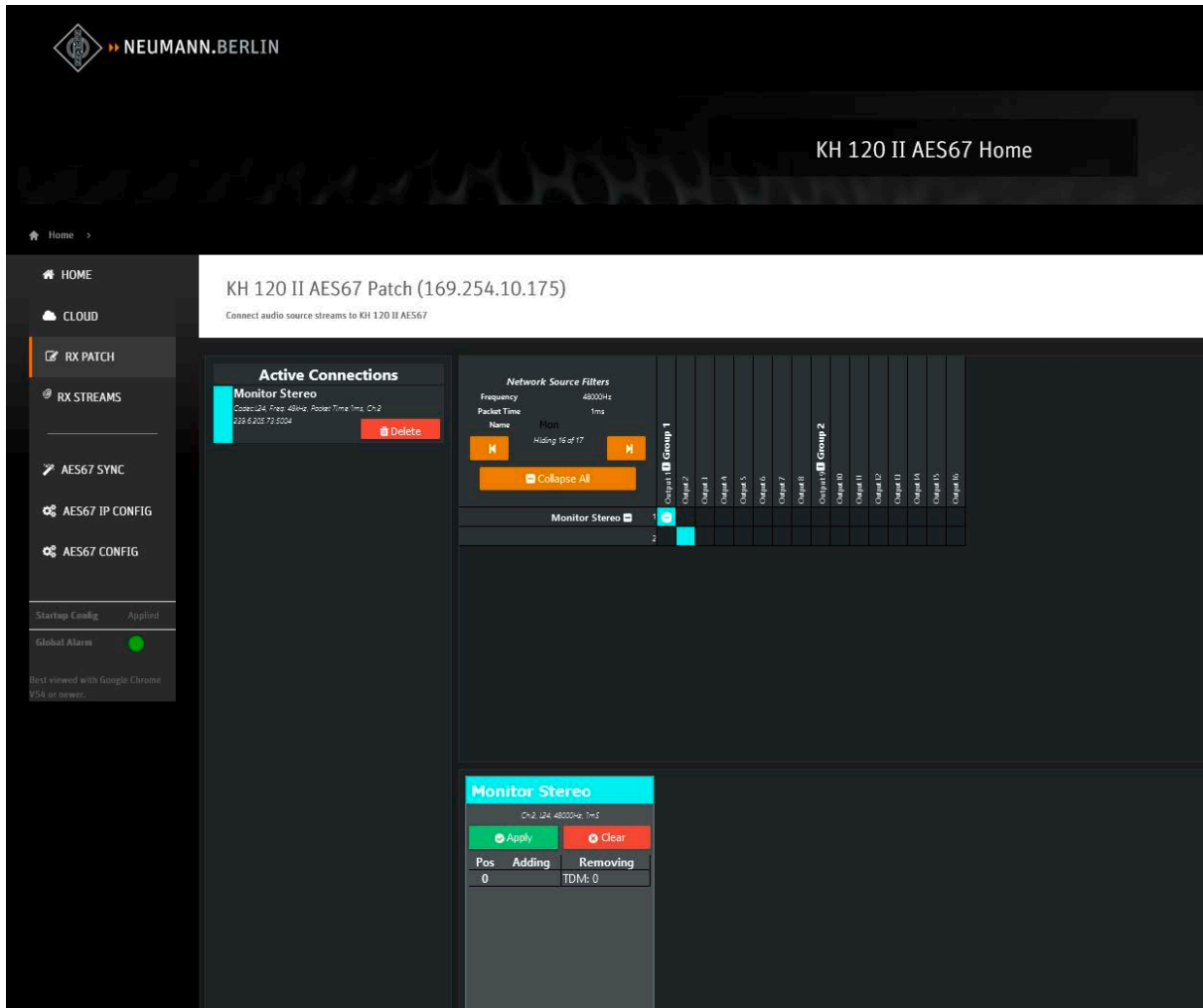

- ▶ In the matrix, click on the cross point in the top left corner. This will route all channels of the AES67 stream to the internal DSP. The matrix will indicate the routed audio with green cross points. The audio will start playing.

To remove a connection:

- ▶ Open the web interface of the KH 750 AES67.
- ▶ Navigate to the **RX PATCH** menu item in the menu on the left. The top left will show all existing AES67 audio sources (streams) in your network.
- ▶ In the matrix, click on the green cross point in the top left corner. This will un-route all channels of the AES67 stream from the internal DSP. The audio will stop playing.



### Routing with RX STREAMS

To establish a connection:

- ▶ Open the loudspeaker’s web interface.
- ▶ Navigate to the **RX STREAMS** menu item in the menu on the left.

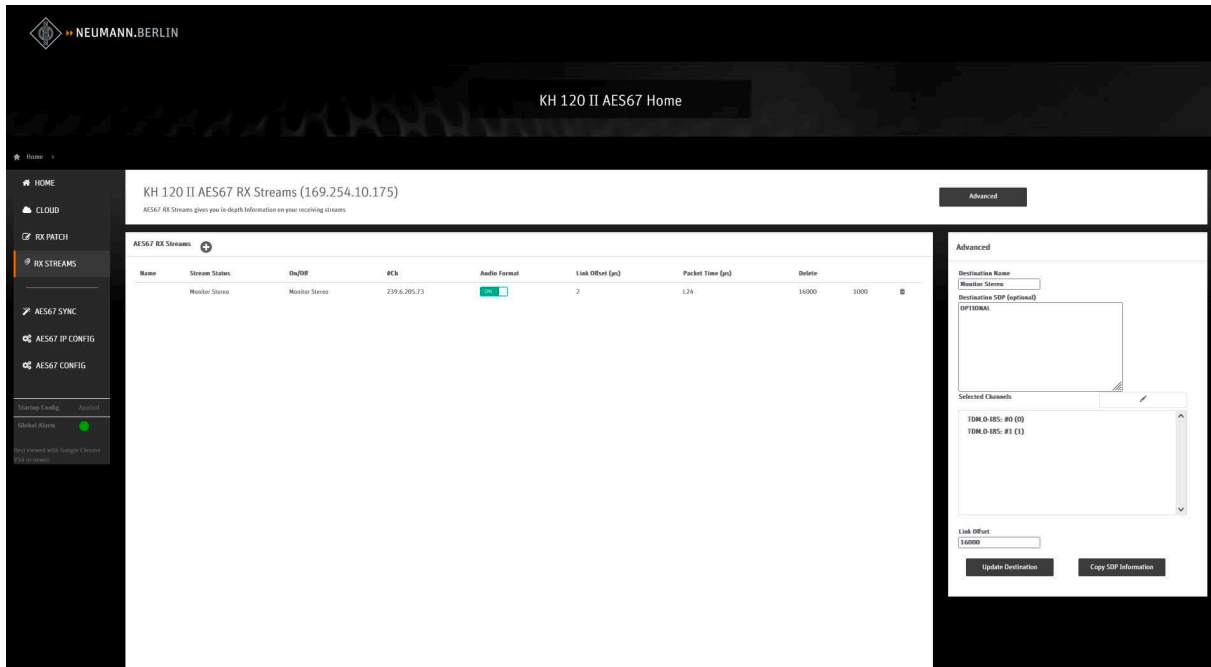

- ▶ Click the **+** icon next to **AES67 RX Streams**.  
The **Advanced** tab on the right will be enabled.  
All discovered AES67 sources will be shown in the **Destination Name** dropdown.
- ▶ Select the desired AES67 stream.
- ▶ Enter a name for the stream.
- ▶ Skip the **Destination SDP** box.
- ▶ Highlight the first two lines in the **Selected Channels** box:  
**TDM.0 – 18S: #0** and **TDM.0 – 18S: #1**
- ▶ Click the downward arrow next to the **Selected Channels** box to enable these internal channels.
- ▶ Leave the **Link Offset** box as it is.
- ▶ Click **Update Destination**.  
This will route all channels of the AES67 stream to the internal DSP.  
The audio will start playing.  
The table in the center of the page will show the routed audio.

To remove a connection:

- ▶ Open the loudspeaker’s web interface.
- ▶ Navigate to the **RX STREAMS** menu item in the menu on the left.  
The table in the center of the page will show the current routed audio.
- ▶ Click on the trash can icon on the right of the list to remove the connection.  
This will un-route all channels of the AES67 stream from the internal DSP.  
The audio will stop playing.  
The entry in the table will be removed.





### Routing with RX STREAMS using an SDP file

To establish a connection:

- ▶ Obtain the SDP file of the AES67 audio stream.
- ▶ Open the loudspeaker’s web interface.
- ▶ Navigate to the **RX STREAMS** menu item in the menu on the left.

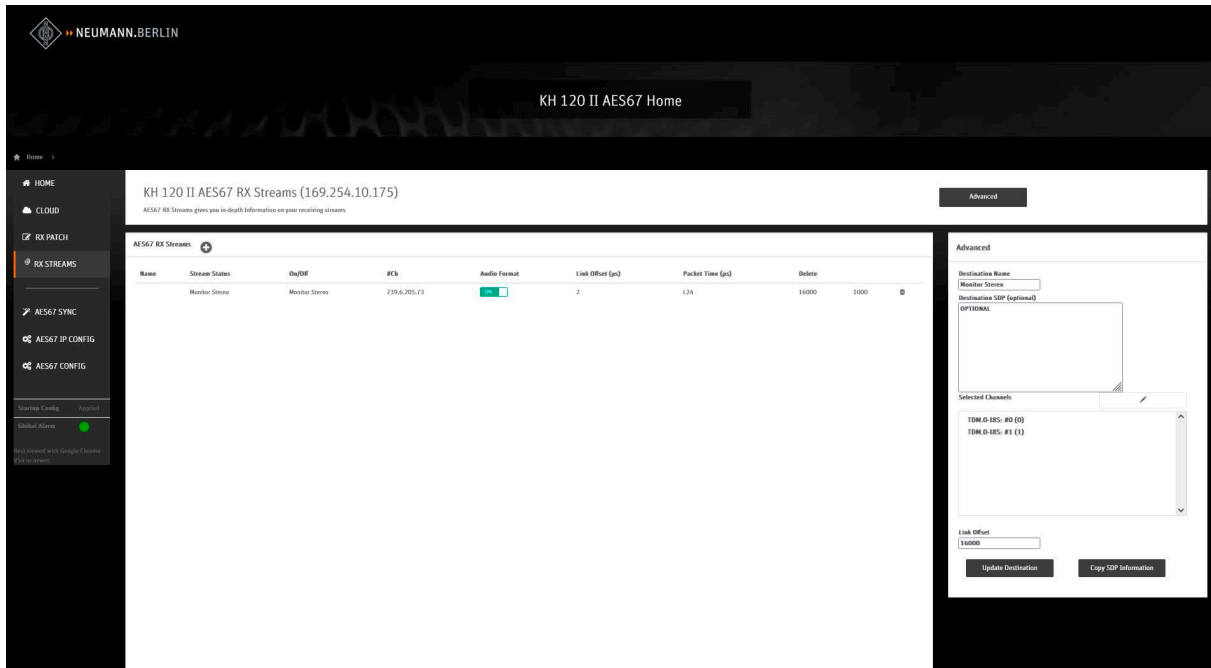

- ▶ Click the **+** icon next to **AES67 RX Streams**.  
The **Advanced** tab on the right will be enabled.
- ▶ Ignore the **Destination Name** dropdown.
- ▶ Enter a name for the stream.
- ▶ Copy the plain text from the SDP file and paste it into the **Destination SDP** box.
- ▶ Highlight the first two lines in the **Selected Channels** box:  
**TDM.0 – I8S: #0** and **TDM.0 – I8S: #1**
- ▶ Click the downward arrow next to the **Selected Channels** box to enable these internal channels.
- ▶ Leave the **Link Offset** box as it is.
- ▶ Click **Update Destination**.  
This will route all channels of the AES67 stream to the internal DSP.  
The audio will start playing.  
The table in the center of the page will show the routed audio.

To remove a connection:

- ▶ Open the loudspeaker’s web interface.
- ▶ Navigate to the **RX STREAMS** menu item in the menu on the left.  
The table in the center of the page will show the current routed audio.
- ▶ Click on the trash can icon on the right of the list to remove the connection.  
This will un-route all channels of the AES67 stream from the internal DSP.  
The audio will stop playing.  
The entry in the table will be removed.



## Routing with ANEMAN

The ANEMAN Network Controller software from Merging Technologies supports the loudspeaker. A useful tool for operating AES67 networks is the MTDDiscovery software by Merging Technologies.

**i** Make sure to install the Ross Video AES67 Plug-In. Follow the instructions by Merging Technologies on how to install plugins in the ANEMAN software.

To establish a connection:

- ▶ On the loudspeaker's web interface, enable ANEMAN Connection Management from the AES67 CONFIG menu item (see "Setting up the ANEMAN/Ravenna connection management" on page 28).
- ▶ Install the ANEMAN Network Controller software by Merging Technologies and the ROSS VIDEO ANEMAN plugin.
- ▶ We also recommend installing the MTDDiscovery software by Merging Technologies.
- ▶ Open the ANEMAN Network Controller software. The loudspeaker will be detected automatically.

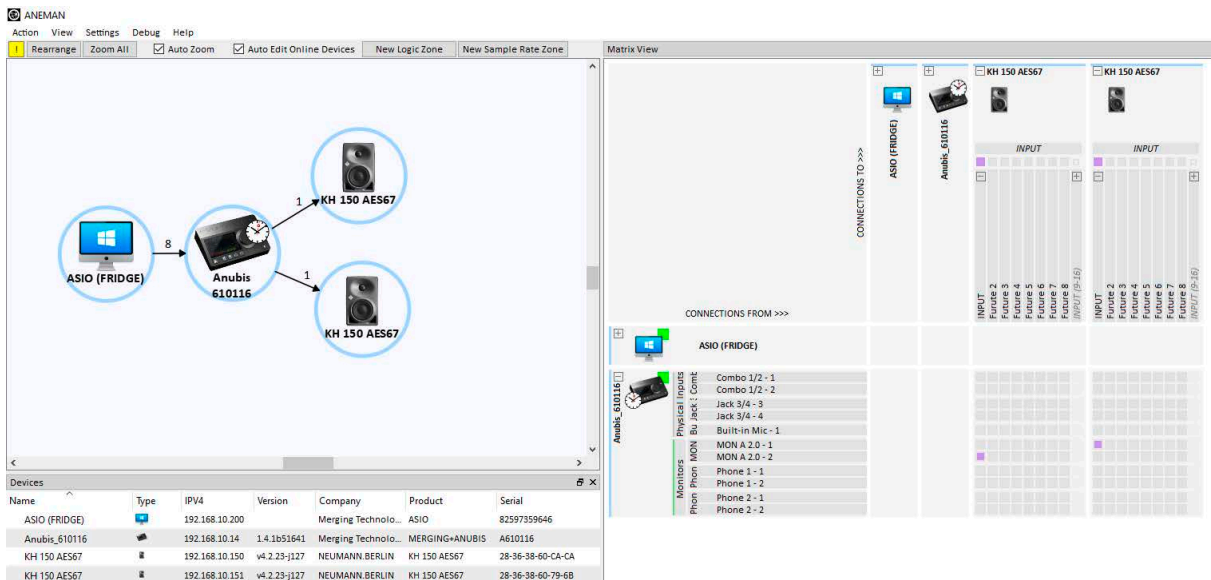

- ▶ Select the source device and the loudspeaker from the **Devices** list while holding down the Ctrl key.
- ▶ Click the audio cross points in the matrix on the right. The cross points become orange.
- ▶ Click **Apply multicast** in the top left corner of the matrix. ANEMAN will send the commands to set up the loudspeaker. Once the connection is made, the cross points become purple and the audio will start playing.

To remove a connection:

- ▶ Select the loudspeaker from the **Devices** list.
- ▶ Click on the cross points.
- ▶ Click **Remove multicast** in the top left corner of the matrix. ANEMAN will send the commands to remove the loudspeaker. The audio will stop playing.



## Compatibility with DANTE® AES67 audio streams

The loudspeaker can receive DANTE® AES67 audio streams.

Please refer to the user manual of your DANTE® interface or contact the manufacturer of your DANTE® interface to find out whether your DANTE® interface is capable of generating AES67-compatible streams. This feature must be implemented by the manufacturer of the DANTE® device.

To enable the DANTE AES67 SAP Protocol:

- ▶ Navigate to the **AES67 CONFIG** menu item.
- ▶ Select **True** from the **Enable** dropdown on the **SAP Configuration** tab.

This will enable the reception and discovery of AES67 streams generated by a DANTE® interface. Routing (reception) of the stream can be done either with ANEMAN or via RX PATCH or RX STREAMS.

 It is not possible to perform this configuration in the DANTE® controller software.

For more information on routing DANTE® AES67 streams with ANEMAN, refer to the documentation provided by Merging Technologies.

### Routing DANTE® AES67 with RX PATCH

To establish a connection:

- ▶ Open the loudspeaker's web interface.
- ▶ Navigate to the **RX PATCH** menu item in the menu on the left. The top left will show all existing DANTE® AES67 audio sources (streams) in your network.
- ▶ In the matrix, click on the cross point in the top left corner. This will route all channels of the DANTE® AES67 stream to the internal DSP. The matrix will indicate the routed audio with green cross points. The audio will start playing.

To remove a connection:

- ▶ Open the loudspeaker's web interface.
- ▶ Navigate to the **RX PATCH** menu item in the menu on the left. The top left will show all existing DANTE® AES67 audio sources (streams) in your network.
- ▶ In the matrix, click on the green cross point in the top left corner. This will un-route all channels of the DANTE® AES67 stream from the internal DSP. The audio will stop playing.

### Routing DANTE® AES67 with RX STREAMS

To establish a connection:

- ▶ Open the loudspeaker's web interface.
- ▶ Navigate to the **RX STREAMS** menu item in the menu on the left.
- ▶ Click the  icon next to **AES67 RX Streams**. The **Advanced** tab on the right will be enabled. All discovered DANTE® AES67 sources will be shown in the **Destination Name** dropdown.
- ▶ Select the desired DANTE® AES67 stream.
- ▶ Enter a name for the stream.
- ▶ Skip the **Destination SDP** box.
- ▶ Highlight the first two lines in the **Selected Channels** box: **TDM.0 – I8S: #0** and **TDM.0 – I8S: #1**
- ▶ Click the downward arrow next to the **Selected Channels** box to enable these internal channels.
- ▶ Leave the **Link Offset** box as it is.
- ▶ Click **Update Destination**. This will route all channels of the DANTE® AES67 stream to the internal DSP.



The audio will start playing.  
The table in the center of the page will show the routed audio.

To remove a connection:

- ▶ Open the loudspeaker's web interface.
- ▶ Navigate to the **RX STREAMS** menu item in the menu on the left.  
The table in the center of the page will show the current routed audio.
- ▶ Click on the trash can icon on the right of the list to remove the connection.  
This will un-route all channels of the AES67 stream from the internal DSP.  
The audio will stop playing.  
The entry in the table will be removed.

### Routing DANTE® AES67 with RX STREAMS using an SDP file

To establish a connection:

- ▶ Obtain the SDP file of the DANTE® AES67 audio stream.
- ▶ Open the loudspeaker's web interface.
- ▶ Navigate to the **RX STREAMS** menu item in the menu on the left.
- ▶ Click the **+** icon next to **AES67 RX Streams**.  
The **Advanced** tab on the right will be enabled.
- ▶ Ignore the **Destination Name** dropdown.
- ▶ Enter a name for the stream.
- ▶ Copy the plain text from the SDP file and paste it into the **Destination SDP** box.
- ▶ Highlight the first two lines in the **Selected Channels** box:  
**TDM.0 – I8S: #0** and **TDM.0 – I8S: #1**
- ▶ Click the downward arrow next to the **Selected Channels** box to enable these internal channels.
- ▶ Leave the **Link Offset** box as it is.
- ▶ Click **Update Destination**.  
This will route all channels of the DANTE® AES67 stream to the internal DSP.  
The audio will start playing.  
The table in the center of the page will show the routed audio.

To remove a connection:

- ▶ Open the loudspeaker's web interface.
- ▶ Navigate to the **RX STREAMS** menu item in the menu on the left.  
The table in the center of the page will show the current routed audio.
- ▶ Click on the trash can icon on the right of the list to remove the connection.  
This will un-route all channels of the DANTE® AES67 stream from the internal DSP.  
The audio will stop playing.  
The entry in the table will be removed.



## Cleaning and maintaining the loudspeaker

### CAUTION

Damage to the product caused by liquids!

Liquids entering the product can cause a short-circuit in the electronics and damage or even destroy the product.

▶ Keep all liquids away from the product!

- ▶ Before cleaning, disconnect the product from the power supply.
- ▶ Use a soft, dry, and lint-free cloth to clean the product.
- ▶ Be careful not to accidentally adjust the controls when cleaning.

## Troubleshooting

Problem	Cause	Solution
The Neumann logo is off, no sound is heard from the loudspeaker.	The loudspeaker's main internal fuse has blown.	Have the product checked by an authorized Neumann service partner. There is no plug fuse in the device.
The Neumann logo is off or not clearly visible, but sound is heard from the loudspeaker.	The Neumann logo is switched off or dimmed.	Switch on the Neumann logo and switch off the dimming (see page 11).
The loudspeaker is buzzing.	Incorrect wiring in the audio cable and/or poor quality grounding in the audio cable.	Check the cabling, especially if unbalanced cabling has been used – see the cable wiring diagram on page 8. Use gold-plated connectors. Set the output level of the loudspeaker as low as possible and set the output level of the audio source as high as possible, without causing it to clip. Set the GROUND LIFT switch to the Lift position.
The loudspeaker sounds very "thin" in the bass. The low frequency response is very low.	Incorrect wiring in the audio cable or adapter.	Check the cabling, especially if unbalanced cabling has been used – see the cable wiring diagram on page 8.
	One loudspeaker is out of phase with the other. This results in cancellation in the low frequency range.	Check the cabling, especially if unbalanced cabling has been used – see the cable wiring diagram on page 8.  Check the settings in the signal source.
Standby is too sensitive or not sensitive enough.	Incorrect standby settings, or noise peaks / extraneous noise in the source.	Check the standby settings and signal source – see "Customizing standby behavior" on page 18.

For further information, please refer to the "Questions & Answers" section on the product page at [www.neumann.com](http://www.neumann.com).



## Specifications

For a complete list of specifications, see the loudspeaker's product page at [www.neumann.com](http://www.neumann.com).

Product properties	KH 120 II AES67	KH 150 AES67
Power supply	100 to 240 V~, 50/60 Hz	
Power consumption (standby/idle)	0.3 W / 17 W	
Power consumption (full load)	320 W	
Dimensions (H x W x D)	287 x 182 x 227 mm 11.3" x 7.2" x 8.9"	345 x 225 x 273 mm 13.6" x 8.8" x 10.7"
Weight	5.4 kg	8.0 kg
Drivers (woofer, tweeter)	130 mm (5.25"), 25 mm (1")	165 mm (6.5"), 25 mm (1")
<b>Temperature</b>		
Operation and storage, unpacked	+10 °C to +40 °C	
Transport and storage, packed in original packaging	-25 °C to +60 °C	
<b>Relative humidity</b>		
Operation and storage, unpacked	max. 75% (non-condensing)	
Transport and storage, packed in original packaging	max. 90% (non-condensing)	

## Acoustical measurements and block diagram

Additional technical data such as acoustical measurements and a block diagram can be found on the loudspeaker's product page at [www.neumann.com](http://www.neumann.com).

## Accessories

Product	Description
LH 28	Tripod stand adapter
LH 29	TV spigot (lighting stand adapter)
LH 32	Wall bracket
LH 37	Subwoofer adapter
LH 43	Surface mounting plate
LH 45	Wall bracket
LH 46	Adjustable ceiling drop adapter
LH 47	Mounting adapter plate
LH 48	Tripod adapter plate
LH 61	Adjustable L-bracket
LH 64	Omnimount/VESA adapter
LH 65	Table stand for KH 120 II
LH 66	Table stand for KH 150

 For a full list of mounting accessories, see the **Mounting Matrix** at [www.neumann.com](http://www.neumann.com).

## Installation angles

