

VIDEO INSTANT REPLAYER P-20HD

Version 1.21 and later



Panel Descriptions	2	Other Functions	39
Top Panel/Front Panel	2	Saving this Unit's Settings to a SD Card/USB Storage	39
Rear Panel (Connecting Your Equipment)	3	Formatting an SD Card	40
Connecting a Footswitch	4	Importing Title Materials	41
Getting Ready	5	Exporting Recorded Video Data	42
Main Screen	5	Exporting/Importing a Project	43
Turning the Power On/Off	8	Turning Off the Power from the Menu	44
About SD Cards	8	Using a Footswitch	44
Operating the Menu	9	Using an Expression Pedal	45
Setting the Date and Time	9	Preventing Unintended Operation (Panel Lock)	46
How the P-20HD is Organized	10	Returning to the Factory Settings (Factory Reset)	46
Video Input/Output Settings	12	Using a USB Keyboard to Operate the P-20HD	47
List of Compatible Video Formats	12	Using LAN	48
Setting the System Frame Rate	12	Using RS-232	50
Specifying the Input Format (EDID)	13	Menu List	52
Setting the Output Format	13	1: Project	52
Creating a Project	14	2: Transition	53
Creating a New Project	14	3: Playlist	54
Opening an Existing Project	14	4: Pad	54
Configuring the Project Settings	14	5: Marker	55
Video Operations	15	6: Video Input	55
Recording and Playback	15	7: Video Output	57
Using Markers (Bookmarks)	17	8: Audio Input	58
Using Clips	19	9: Audio Output	59
Clip List Operations	24	10: Audio Rec Level	61
Pad Operations	25	11: SD Card/USB Memory	61
Using the Palettes	25	12: Annotation	61
Other Palette Operations	26	13: Ctl/Exp.	62
Using Still Images	27	14: RS-232	63
Using Audio Files	29	15: LAN	63
Adjusting the Video	30	16: System	64
Audio Operations	32	CLIP LIST	66
Adjusting the Volume	32	PALETTE	66
Applying Effects to the Input Audio	32	STILL	67
Applying Effects to Output Audio	33	AUDIO	67
Muting Only Specific Audio (Mute)	34	List of Shortcut Keys	68
Switching Between Audio Output from Each Output Connector	34	Remote Control Commands (LAN/RS-232)	69
Mixing the AUDIO IN Audio with the Audio from the Video	35	Appendix	71
Annotation	36	Troubleshooting	71
Connecting a Pen Display/ Pen Tablet	36	Error Message List	72
Getting Ready to Use Annotation	37	Approximate Recording Times	72
Drawing on the Screen	38	Main Specifications	73
		Dimensions	74
		Video Block Diagram	75
		Audio Block Diagram	76

Panel Descriptions

Top Panel/Front Panel



Front Panel

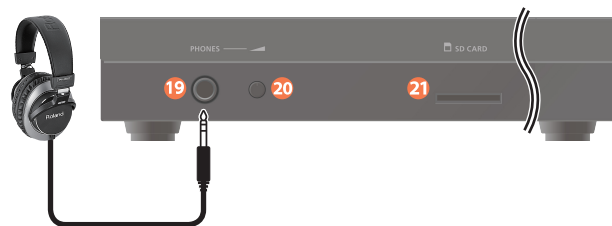

Name	Explanation
19 PHONES jack	Connect your headphones here.
20 [PHONES] knob	Adjusts the headphone volume.
21 SD card slot	Insert an SD card here.

Name	Explanation				
INPUT section					
1 [REC] button	Starts/stops recording. <table border="1"> <tr> <td>Lit</td> <td>Recording</td> </tr> <tr> <td>Unlit</td> <td>Recording stopped</td> </tr> </table> <p>To stop recording, hold down the [REC] button and press the [EXIT] button.</p>	Lit	Recording	Unlit	Recording stopped
Lit	Recording				
Unlit	Recording stopped				
2 [SELECT] button	Switches between input video (LIVE IN 1/LIVE IN 2/ PinP/SPLIT). The LED for the selected input lights up.				
3 [AUDIO OUT] knob	Adjusts the output volume.				
Pad section					
4 [STILL] button	Switches the pad functions to select still image clips.				
[AUDIO] button	Switches the pad functions to select audio clips.				
[CLIP LIST] button.	Switches the pad functions to select video clips.				
[PALETTE] button	Switches the pad functions to select video clips within a palette.				
5 Pads [1]–[8]	Used for selecting the clip (video/still image/ audio) assigned to each pad.				
6 [<] [>] buttons	Switches the pad page.				
7 [SPEED] lever	Adjusts the playback speed.				
8 [SPEED RANGE] button	Switches between ranges of playback speeds that can be adjusted using the [SPEED] lever.				
OUTPUT section					
9 [LIVE IN] button	Outputs video from the LIVE IN bus.				
[REPLAY] button	Outputs video from the REPLAY bus.				
AUTO PLAY section					
10 [CLIP] button	Plays back the video clip.				
[PLAYLIST] button	Plays back the playlist.				
11 Cooling vents	Heat from inside the P-20HD is released from these vents. * Do not block the cooling vents. If the cooling vents are blocked, the internal temperature might rise, causing the unit to malfunction.				

Name	Explanation				
MARKER section					
[LIVE IN] button	Switches between marker reference times. <table border="1"> <tr> <td>Lit</td> <td>LIVE IN time</td> </tr> <tr> <td>Unlit</td> <td>REPLAY time</td> </tr> </table>	Lit	LIVE IN time	Unlit	REPLAY time
Lit	LIVE IN time				
Unlit	REPLAY time				
[DELETE] button	Deletes a bookmark.				
12 [IN] [OUT] buttons	Sets the video clip's start time (IN point) and end time (OUT point).				
[BOOKMARK] button	Sets a marker (bookmark) in the recording data.				
[MAKE CLIP] button	Creates a video clip whose OUT point is the moment at which you press the button.				
TRANSPORT section					
13 [] button	Stops the video that's currently playing back. <table border="1"> <tr> <td>Video</td> <td>Paused</td> </tr> <tr> <td>Audio</td> <td>Muted</td> </tr> </table>	Video	Paused	Audio	Muted
Video	Paused				
Audio	Muted				
[▶] button	Plays back the recorded video.				
[◀] [▶] buttons	Jumps to the next bookmark (or previous bookmark).				
14 [MENU] button	Shows or hides the menu.				
15 [EXIT] button	Exits a menu level or cancels an operation.				
16 [VALUE] knob (ENTER)	<table border="1"> <tr> <td>Turning</td> <td>Selects a menu item, or edits the value of a setting.</td> </tr> <tr> <td>Pressing</td> <td>Confirms a selected menu item or an edited setting. Also executes an operation.</td> </tr> </table>	Turning	Selects a menu item, or edits the value of a setting.	Pressing	Confirms a selected menu item or an edited setting. Also executes an operation.
Turning	Selects a menu item, or edits the value of a setting.				
Pressing	Confirms a selected menu item or an edited setting. Also executes an operation.				
JOG/SHUTTLE section					
17 [JOG] button	Sets the [JOG/SHUTTLE] dial to jog mode (p. 15).				
[SHUTTLE] button	Sets the [JOG/SHUTTLE] dial to shuttle mode (p. 15).				
18 [JOG/SHUTTLE] dial	In jog mode/shuttle mode, adjust the frame advance, frame rewind, and playback speed. When you press the dial while in shuttle mode, shuttle mode is turned off.				

Rear Panel (Connecting Your Equipment)

- * To prevent malfunction and equipment failure, always turn down the volume, and turn off all the units before making any connections.
- * Be sure to use cables and adaptor plugs with the proper connectors matching those of the other devices you are using.
- * Before disconnecting an SD card or a USB storage while the power is on, be sure to eject the media by using the Eject command on this unit (p. 8, p. 61).

CTL/EXP 1, 2 jacks

You can connect a footswitch (such as a BOSS FS-6, sold separately) or expression pedal (such as the EV-5, sold separately) to this jack. Use this when you want to switch between video using your foot.

* Use only the specified expression pedal (Roland EV-5, BOSS FV-500L/FV-500H; sold separately). Connecting any other expression pedals may cause malfunctions and/or damage to this unit.

AUDIO OUT L, R jacks

These output the resulting audio mix. Use these to connect an audio recorder, amplifier, speakers, or related equipment.

DC IN jack

Connect the included AC adaptor to this jack.

* Use the cord hook to secure the cord of the AC adaptor as shown in the illustration.

AUDIO IN L, R jacks

Use these jacks for audio input. Connect an audio mixer, CD player, or other audio equipment.

Ground terminal

Connect this to an external earth or ground, if necessary.

USB 3.0 port

Connect USB storage such as a USB flash drive or an external SSD, and use it to back up this unit's settings or import materials from storage into this unit.

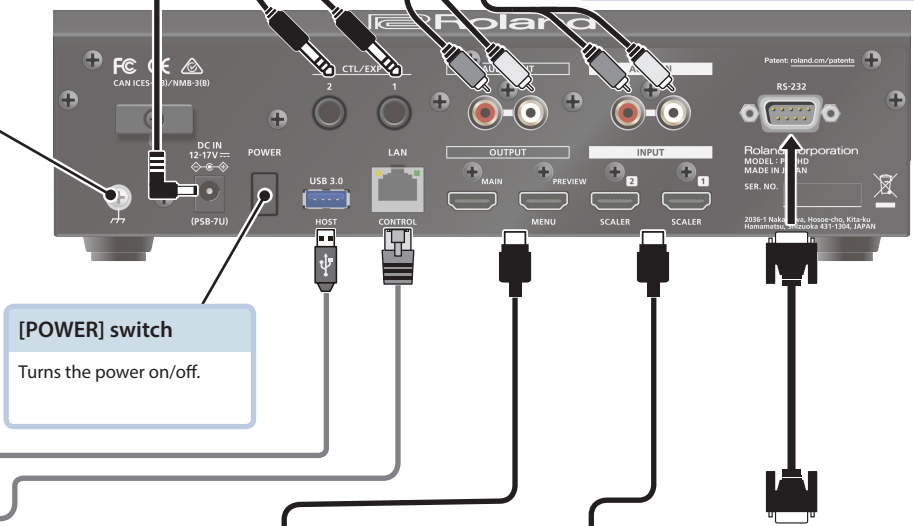

LAN CONTROL jack

Connect this to a network device such as a computer or other network device to remotely control or to exchange files with the P-20HD.

* As this port supports GbE, use a CAT5e LAN cable or higher.

OUTPUT (MAIN/PREVIEW) connectors

These connectors are for video output. Connect them to devices such as projectors or external displays.

* The menu of the P-20HD is shown on this unit's display and on the display connected to the OUTPUT PREVIEW connector.

INPUT 1-2 connectors

These connectors are for video input. Connect a video device with an HDMI output connector such as a camera, or other devices like a computer.

RS-232 connector

A remote-control device (such as a computer that supports RS-232) can be connected here to remotely control the P-20HD.

Connecting a Footswitch

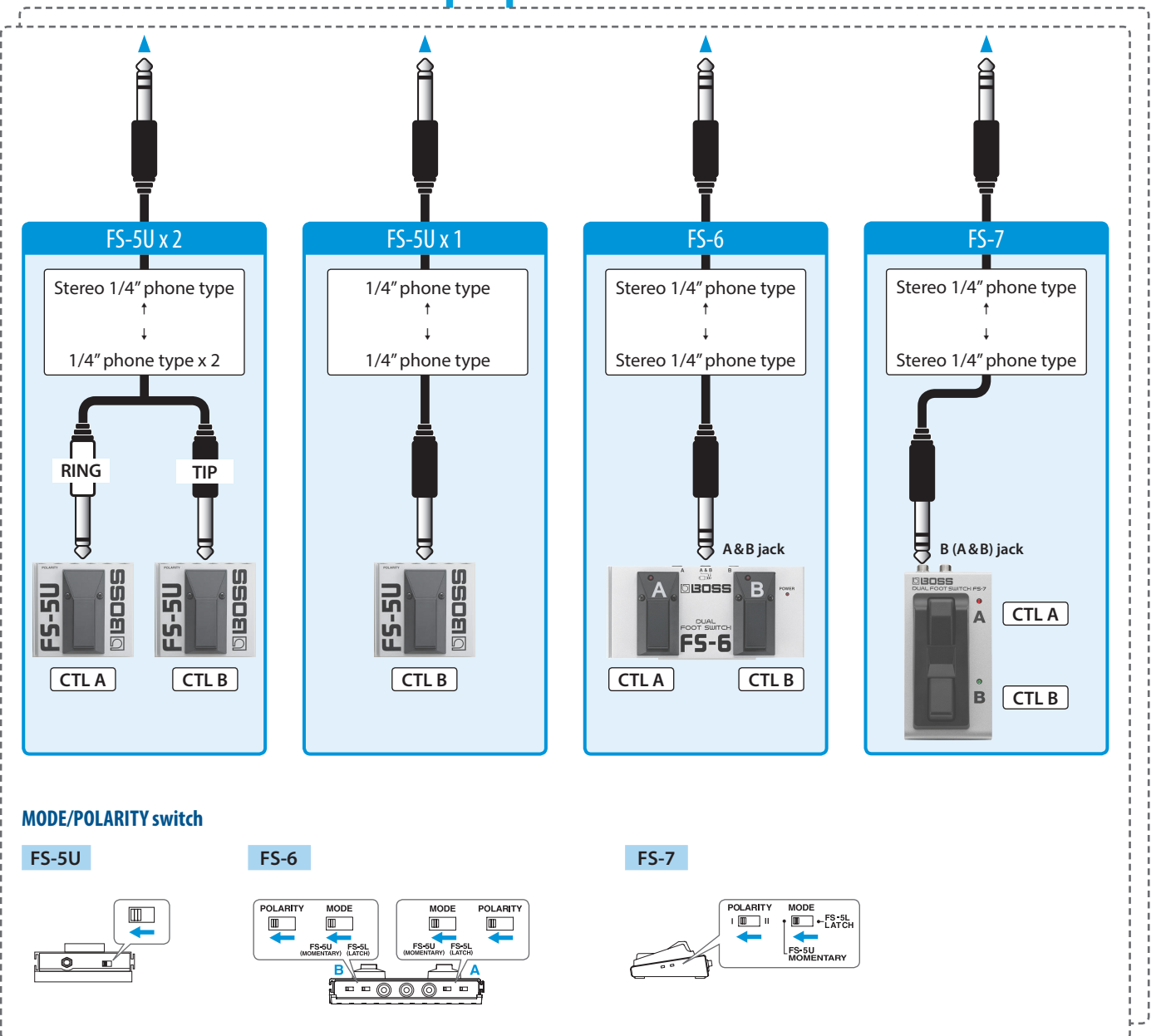

NOTE

The BOSS FS-6's A, B, and A & B jacks also act as the power switch. The power turns on when you insert a plug into the jack, and turns off when you remove the plug.

To prevent the batteries from running down, remove the plugs from the jacks when you're not using the BOSS FS-6.

Getting Ready

Main Screen

This is the main screen of the P-20HD.

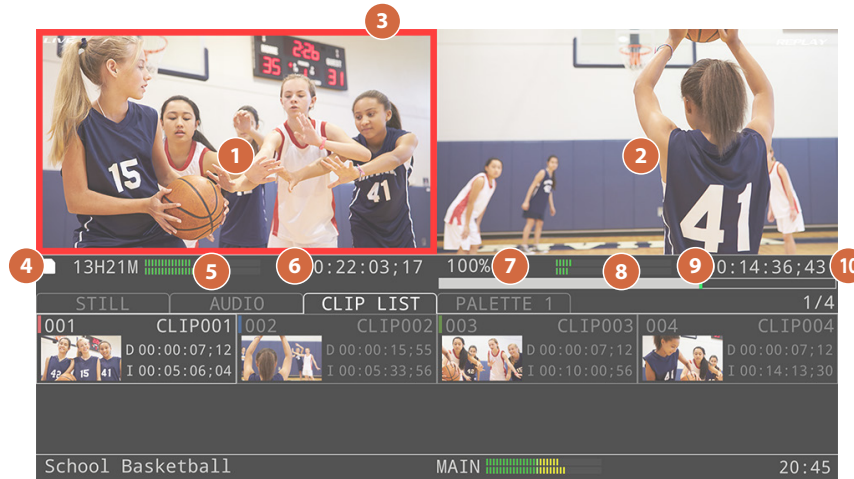

Name	Explanation																
1 LIVE IN video preview area	Displays the preview video for the recording content that is being input. You can also change the input video with the INPUT SELECT.																
2 REPLAY video preview area	Displays the preview video for the video that is playing back. When in shuttle mode, a gauge is shown on the preview screen that indicates the shuttle dial's angle (the playback speed rate).																
3 Tally frame	A red border is displayed around the preview area of the side that is selected as the MAIN output video. You can switch the MAIN output video using the OUTPUT switch buttons. The tally frame is displayed on both the LIVE IN and REPLAY areas while switching.																
4 SD card icon and remaining time display	Displays the recording time available on the SD card in (min:sec) format. When the remaining time goes down to 30 minutes, the icon turns yellow; and when the remaining time goes down to 15 minutes, the icon turns red. When the remaining time reaches zero, recording automatically stops. "--H--M" is displayed if a card is not inserted. The  mark appears when the SD card is locked.																
5 LIVE IN audio level meter	Displays the audio levels for the LIVE IN bus (p. 32).																
6 Record icon and recording time indicator	An icon (●) showing the recording status and the recording time is shown. If recording is stopped, the ● icon is hidden, and the recording time indicates (*) the existing recording time. "--:--:--" (*) is shown at the point where no recording exists. * This is shown in "HH:MM:SS; frame" format when the system frame rate is 59.94. This is shown in "HH:MM:SS" format when the system frame rate is 50.																
7 Playback speed indicator	Shows the playback speed. This shows the speed from -100% to 100% according to the [SPEED] lever position, and the rate of playback (x-128, x-64, x-32, x-16, x-8, x-4, x-2, x-1, x1, x2, x4, x8, x16, x32, x64, x128) according to the shuttle operation.																
8 REPLAY audio level meters	Displays the audio levels for the REPLAY bus (p. 32).																
9 Playback status icon	Shows an icon indicating the playback status. <table border="1"> <tr> <td>Hidden</td> <td>Before playback starts</td> </tr> <tr> <td> </td> <td>Paused (playback speed = 0%)</td> </tr> <tr> <td>▶</td> <td>During playback (playback speed = 100%)</td> </tr> <tr> <td>◀</td> <td>During reverse playback (playback speed = -100%)</td> </tr> <tr> <td>▶▶</td> <td>Fast-forward (playback speed > 100%)</td> </tr> <tr> <td>◀◀</td> <td>Reverse playback (playback speed < -100%)</td> </tr> <tr> <td>▶ </td> <td>Frame advance/slow-motion playback (frame advance/0% < playback speed < 100%)</td> </tr> <tr> <td>◀ </td> <td>Frame rewind/reverse slow-motion playback (frame advance/-100% < playback speed < 0%)</td> </tr> </table>	Hidden	Before playback starts		Paused (playback speed = 0%)	▶	During playback (playback speed = 100%)	◀	During reverse playback (playback speed = -100%)	▶▶	Fast-forward (playback speed > 100%)	◀◀	Reverse playback (playback speed < -100%)	▶	Frame advance/slow-motion playback (frame advance/0% < playback speed < 100%)	◀	Frame rewind/reverse slow-motion playback (frame advance/-100% < playback speed < 0%)
Hidden	Before playback starts																
	Paused (playback speed = 0%)																
▶	During playback (playback speed = 100%)																
◀	During reverse playback (playback speed = -100%)																
▶▶	Fast-forward (playback speed > 100%)																
◀◀	Reverse playback (playback speed < -100%)																
▶	Frame advance/slow-motion playback (frame advance/0% < playback speed < 100%)																
◀	Frame rewind/reverse slow-motion playback (frame advance/-100% < playback speed < 0%)																



Name	Explanation
10 Playback time display	Shows the playback time (*). * This is shown in "HH:MM:SS; frame" format when the system frame rate is 59.94. This is shown in "HH:MM:SS: frame" format when the system frame rate is 50.
11 Timeline display	Displays the playback position within the recording time. The full length of the timeline bar shows the recording time, and the length of the position bar (the gray area) shows the playback time.
12 Marker position display	The yellow-green indication on the timeline shows the marker position. If the LIVE IN marker button is unlit, this appears at the playback position (at the front of the position bar). If the LIVE IN marker button is lit, this appears at the recording position (the right side of the timeline). Pressing the [IN] button creates an IN point marker, indicated by a marker on the timeline. Pressing the [BOOKMARK] button creates a bookmark at the marker position, and indicators appear on the light blue markers on the timeline.
13 Pad tab	This tab shows the type of pad that's now selected. The display changes according to the selection made using the pad switching buttons. If the PALETTE button is lit, the selected palette number is shown in the tab to indicate the palette number. Example: PALETTE 1
14 Selected clip and no. of clips indicator	Shows the position of the selected clip in the list, and the total number of clips.
15 Clip display	This area is used for displaying each clip. The selected clip is highlighted.
16 Project name	Shows the name of the project. This is hidden if a project is not open.
17 MAIN bus level meter	This is the audio output level meter for the MAIN bus.
18 Current time	Shows the current time, or the date and time.

Video Clip

Name	Explanation
19 Clip color indicator	Shows the color label that's set for each clip.
20 Clip number	Shows the clip position within the list.
21 Thumbnail	Shows a thumbnail of the clip. A temporary thumbnail is shown if an actual thumbnail has not been created.
22 Clip name	Shows the name of the clip (maximum of 10 characters).
23 Clip length indicator	Shows the length of the clip.
24 Clip IN point indicator	Shows the time of the IN point for the clip.

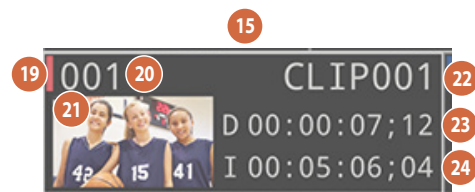

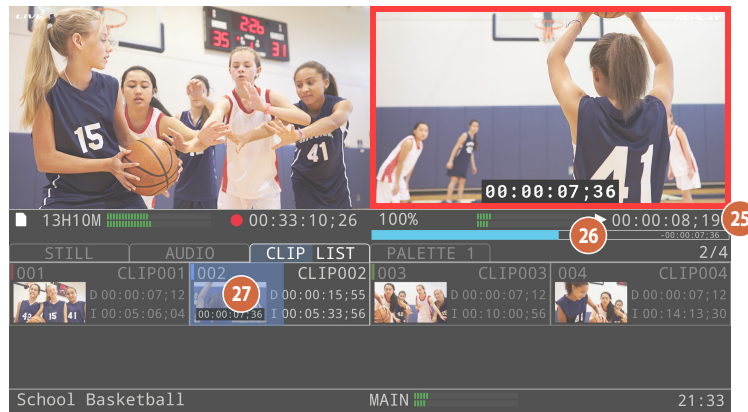

Name	Explanation
When playing back a clip	
25 Playback time display	Shows the playback time from the beginning of the clip. The remaining playback time is shown on the preview screen when either a clip or a playlist is playing back.
26 Timeline display	The playback position is shown, with the clip length being the total length. The position bar is shown in light blue.
27 Playback clip display	For the clip area of the playback target, the playback position is displayed, with the clip area width being the clip length. Also, the remaining playback time for the clip is shown inside the thumbnail.
When playing back a playlist	



When playing back a playlist, the clips in the palette play back in order from the beginning. For the timeline and playback time, the playback position is shown respective to the total of all clips in the playlist.

Still image clips

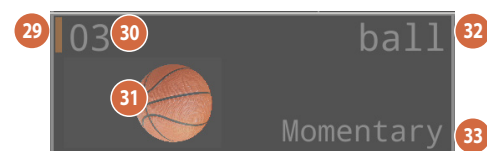
28 Clip display	This area is used for displaying each clip. The selected clip is highlighted. The clip now playing back is shown in yellow.
29 Clip color indicator	Shows the color label that's set for each clip.
30 Clip number	Shows the clip position (01–16) within the list.
31 Thumbnail	Shows a thumbnail of the clip.
32 Clip name	Shows the name of the clip (maximum of 10 characters).
33 Playback action display	Shows the playback mode (Latch/Momentary) set for the clip.



Audio clips

34 Clip display	This area is used for displaying each clip. The selected clip is highlighted. The orange area shows the playback progress for the clip now playing back.
35 Clip color indicator	Shows the color label that's set for each clip.
36 Clip number	Shows the clip position within the list.
37 Thumbnail	Shows an audio thumbnail (musical note icon). The remaining time for the clip is shown on the thumbnail during playback.
38 Clip name	Shows the name of the clip (maximum of 10 characters).
39 Clip length indicator	Shows the length of the clip.
40 Playback action display	Shows the playback mode (Latch/Momentary) set for the clip.
41 Loop setting indicator	Shows the icon corresponding to the loop setting. Loop is set to OFF:  Loop is set to ON: 

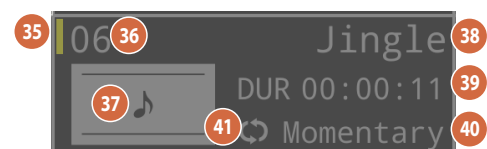

Turning the Power On/Off

- * Once everything is properly connected (p. 3), be sure to follow the steps below to turn on the power of the respective equipment. If you turn on equipment in the wrong order, you risk causing malfunction or equipment failure.
- * Before turning the unit on/off, always be sure to turn the volume down. Even with the volume turned down, you might hear some sound when switching the unit on/off. This is normal and is not a malfunction.
- * Make sure to execute the proper shutdown operations when turning off the power.

Turning the power on

1. Make sure that all devices are powered off.
2. Turn on the [POWER] switch of the P-20HD.

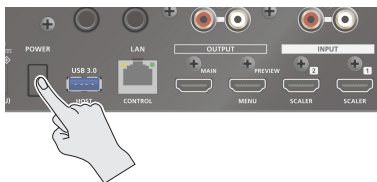

3. Turn on the power of the source devices.
Turn on the power of the source devices that are connected to the P-20HD's input connectors, such as video cameras.
4. Turn on the power of the output devices.
Turn on the power of the devices that are connected to the P-20HD's output connectors, such as projectors.

Turning the power off

1. Turn off the power of the output devices first, and then the source devices.
2. Turn off the [POWER] switch of the P-20HD.

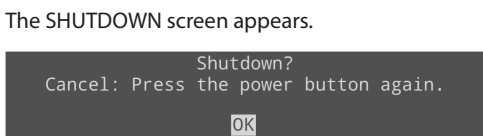

3. Press the [VALUE] knob to finish shutting down.
If you wish to cancel, press the [POWER] switch again.

About the Auto-off function

If 240 minutes pass while the P-20HD remains in the following state, the Auto-off function on this unit automatically turns off the power.

- No operation performed on the P-20HD
- No audio or video input
- No equipment connected to the OUTPUT jacks

The Auto-off function is turned off by factory default. To turn the Auto-off function on, set "Auto Off" in the System menu to "On."

- * Note that any unsaved data is lost when the power turns off. You must save any data in advance that you want to keep.
- * To restore power, turn the power on again.

About SD Cards

You can't use the features of the P-20HD without inserting an SD card, except for making menu settings. Make sure to insert an SD card before you use this unit.

SD cards that can be used on the P-20HD



SDXC cards can be used on the P-20HD.

Some SD card types or SD cards from some manufacturers may not properly record audio/video with this unit.

As a rule of thumb, use an SD card with a data transfer speed of least 20 MB/sec in a speed test.

SD, SDHC, and microSD cards cannot be used.

The available recording time depends on the card's storage capacity (p. 72).

Refer to the support page on the Roland website for the latest information on compatibility.

<https://roland.cm/p-20hd>

Write-Protect (LOCK) Function

The P-20HD cannot use the SD card if it is locked. Unlock the SD card before use.



Inserting the SD Card

1. Push the SD card all the way into the SD CARD slot until you hear a click.

- * Ensure that the SD card is oriented correctly, and insert it all the way into the port. Do not forcibly push the card into place.



Formatting an SD Card

Make sure that the SD card you want to use on the P-20HD is properly formatted using the P-20HD.

- * Note that any data that is deleted as a result of formatting the media cannot be recovered. Back up any important data to your computer beforehand.

1. Follow these steps: press the [MENU] button → "SD Card/USB Memory" → "SD Card" → select "Format" and press the [VALUE] knob.

2. A dialog appears, select "OK," and press the [VALUE] knob.

The SD card is formatted.

Removing the SD Card

1. Follow these steps: press the [MENU] button → "SD Card/USB Memory" → "SD Card" → select "Eject" and press the [VALUE] knob.

Once the message "The SD Card is safe to remove" is displayed on the screen, you can safely remove the card.

- * You can also press the [EXIT] button along with the [MENU] button to perform the same operation as shown in step 1 (shortcut operation).

2. Push the SD card further into the slot.

3. Hold the SD card and pull it out towards you.

Operating the Menu

Here's how to access the menu and configure the settings for video and for the P-20HD.

* The menu is also shown on the monitor that's connected to the OUTPUT PREVIEW connector.

1. Press the [MENU] button to display the menu.

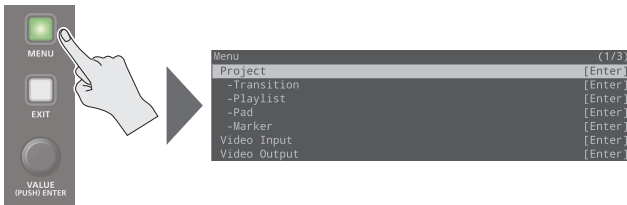

The [MENU] button lights, and the menu categories are shown.

2. Turn the [VALUE] knob to select the category, and press the [VALUE] knob to confirm.

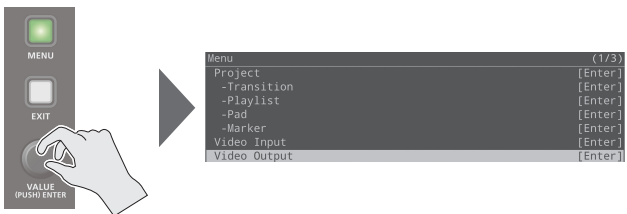

The menu items of the selected category are displayed.

3. Turn the [VALUE] knob to select the menu item to edit, and press the [VALUE] knob to confirm.

The cursor moves to the value.

- If the setting is deep down in the menu directory, repeat step 3.
- Press the [EXIT] button to go back up one level.

4. Turn the [VALUE] knob to change the value of the setting.

- By turning the [VALUE] knob while pressing it, you can make larger changes to the value.
- Hold down the [VALUE] knob to reset the menu item you're currently setting to its default value.

5. Press the [VALUE] knob to confirm the setting.

The cursor returns to the menu item.

6. Press the [MENU] button to close the menu.

Setting the Date and Time

Follow the steps below to set the internal clock the first time you turn on this unit. The date and time you set here is shown onscreen, and is stored as data in the files you record.

NOTE

- The battery-powered internal clock keeps operating even after the power is turned off.
- If the battery runs out, the message "Battery Error" is displayed. If you see this message, contact the nearest Roland Service Center.

1. Follow the steps: press the [MENU] button → "System" → select "Date & Time Settings," and press the [VALUE] knob.



2. From the "Date/Time/Time Zone/Date Format" items, select "Date" and press the [VALUE] knob.

A dialog box for changing the date and time appears.



3. Select the item in the date display (YYYY/MM/DD format) that you wish to change, and press the [VALUE] knob.

The unit enters numerical edit mode, and the value to edit blinks.

4. Use the [VALUE] knob to change the value, and press the [VALUE] knob.

5. Repeat steps 3–4 to set the year, month and day.

6. Select "OK" to close the dialog box.

7. Set the "Time", "Time Zone", and "Date Format" in the same way.

8. After you've set the necessary values, select "Set" and press the [VALUE] knob.

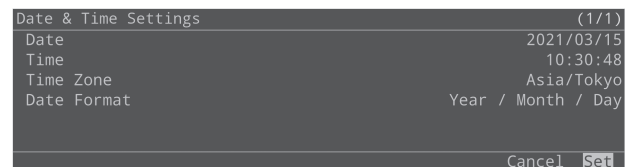

This confirms the values you set.

If you select "Cancel," the values you set are discarded and returned to their original values.

9. A dialog appears, select "OK," and press the [VALUE] knob.

10. A dialog appears again, select "OK," and press the [VALUE] knob.

How the P-20HD is Organized

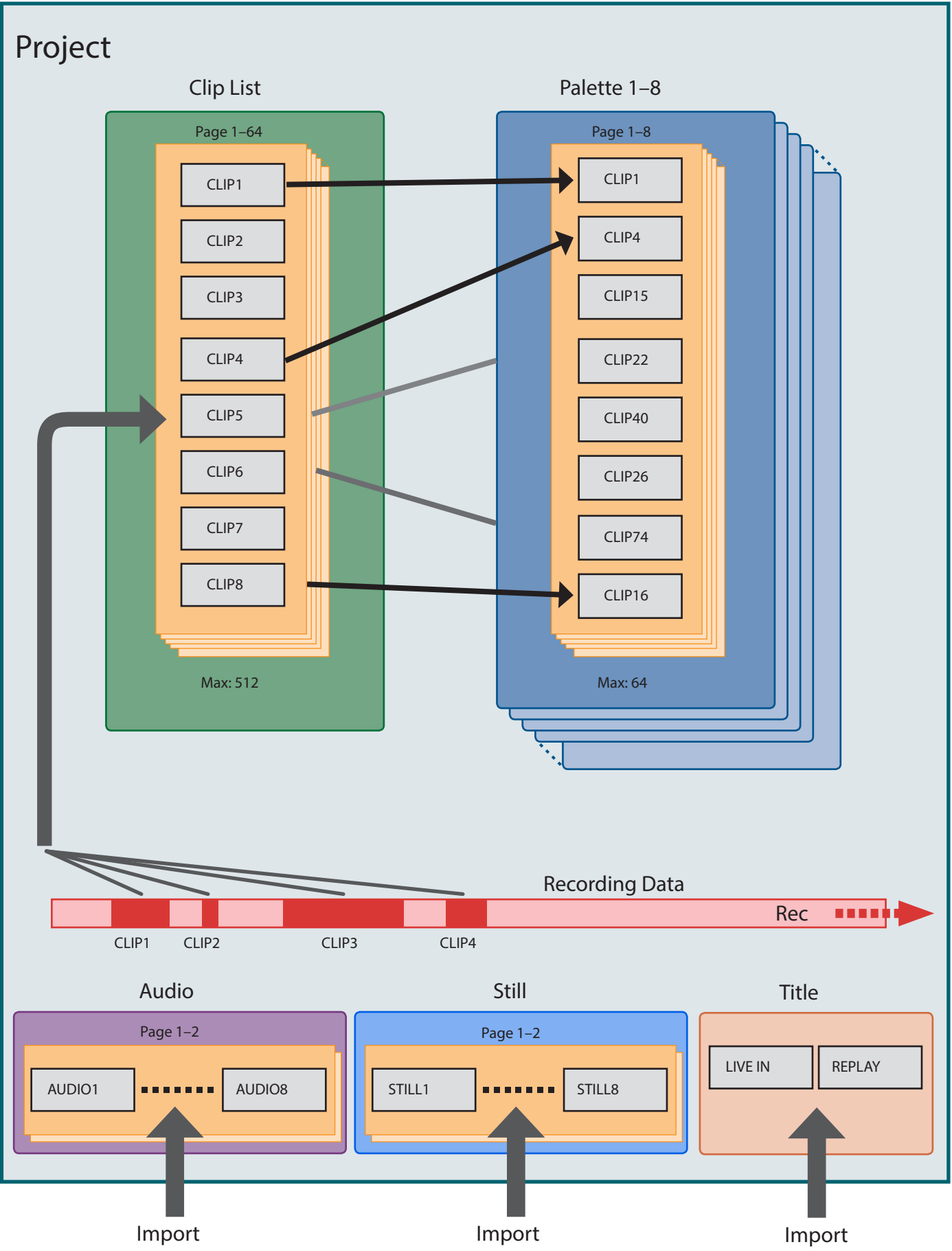

Terms used	Explanation
Project	On the P-20HD, a project is used for managing material (unprocessed content) and operation-related settings as a unit.
Recording data	This is the video data you've recorded. Even if video recording is stopped, you can simply start recording again to create a continuous block of data. Up to 12 hours of video can be recorded per project. Create your video clips by entering the IN and OUT points of the recording data.
Clip	This is a unit of playback over a specified range of time. There are three kinds of clips: video, still images and audio.
Still image (still)	This is where still image clips are stored. You can import up to 16 still image files.
Audio	This is where audio clips are stored. You can import up to 16 audio files.
Clip list	This is the video material storage area, where all video clips within a project are stored. Create your video clips by setting the time ranges from recording data. The video clips you create are registered in the clip list. Add these clips from the clip list to the palette as necessary to manage and play them back.
Palette	This is a collection of video clips provided for you to group together or play back in continuous order in a playlist. Eight palettes are available for each project.
Page	Each type of clip is grouped into units of eight within the material storage area. These units are respectively called "pages." <ul style="list-style-type: none"> • Up to 16 audio or still image clips can be stored, which is two pages. • You can store up to 512 clips in the clip list, meaning a maximum of 64 pages. • You can have up to 64 clips in a palette, meaning a maximum of eight pages.
Marker	Markers are used to "bookmark" recording data in order to create clips or jump to specific positions. There are three types of markers, "IN," "OUT" and "BOOKMARK." * Each recording data can have up to 64 bookmarks. * A bookmark is automatically added when recording additional material.

SD Card Folder Structure

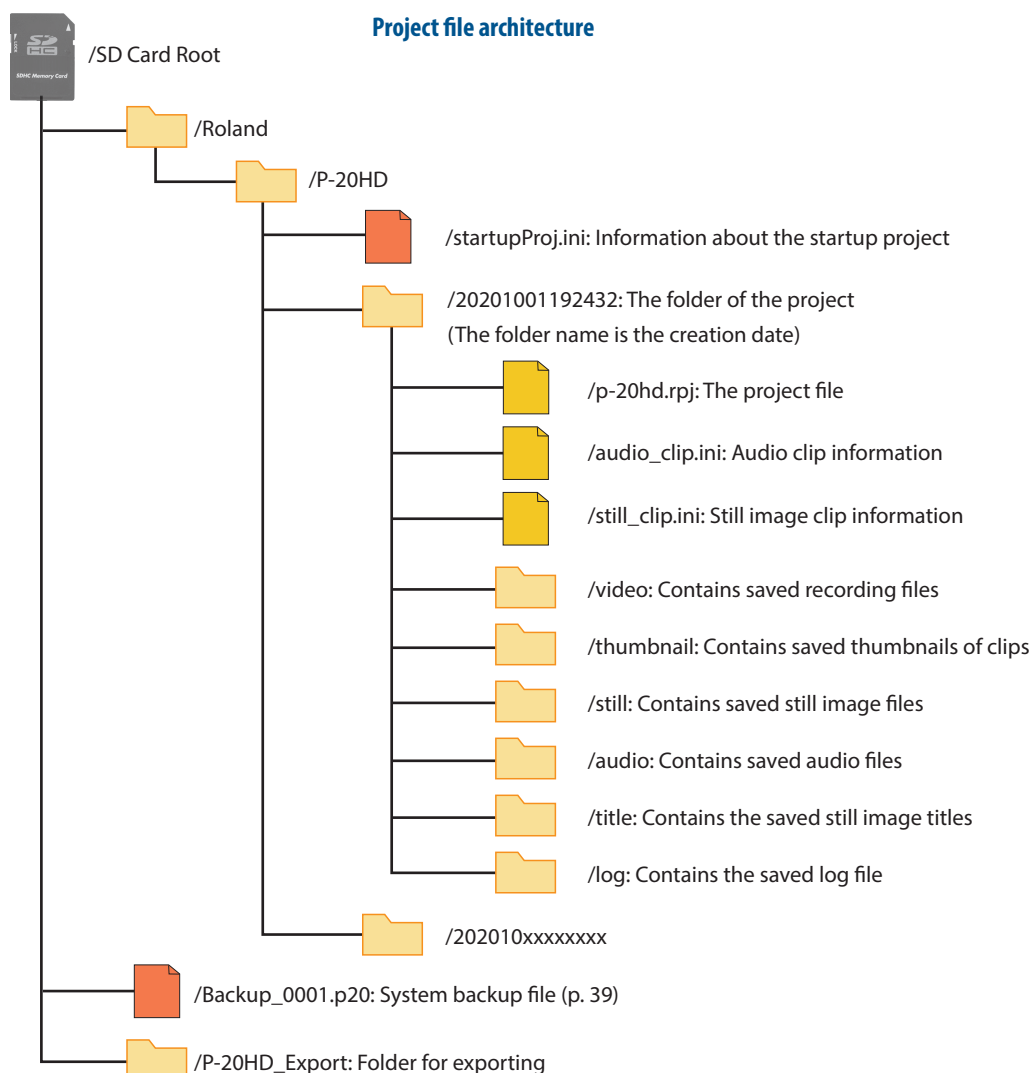

Video Input/Output Settings

List of Compatible Video Formats

The P-20HD supports input and output of signals in the following formats, regardless of the format in which the video was recorded.

Input formats

Frame rate	
When set to "59.94 Hz"	When set to "50 Hz"
720/59.94p	720/50p
1080/59.94i	1080/50i
1080/59.94p	1080/50p
SVGA (800 x 600/60 Hz)	SVGA (800 x 600/60 Hz)
XGA (1024 x 768/60 Hz)	XGA (1024 x 768/60 Hz)
WXGA (1280 x 800/60 Hz)	WXGA (1280 x 800/60 Hz)
FWXGA (1366 x 768/60 Hz)	FWXGA (1366 x 768/60 Hz)
SXGA (1280 x 1024/60 Hz)	SXGA (1280 x 1024/60 Hz)
SXGA+ (1400 x 1050/60 Hz)	SXGA+ (1400 x 1050/60 Hz)
UXGA (1600 x 1200/60 Hz)	UXGA (1600 x 1200/60 Hz)
Full HD (1920 x 1080/60 Hz)	Full HD (1920 x 1080/60 Hz)
WUXGA (1920 x 1200/60 Hz)	WUXGA (1920 x 1200/60 Hz)

Audio input format HDMI: Linear PCM, 24 bits, 48 kHz, 2 ch

Output formats

Frame rate	
When set to "59.94 Hz"	When set to "50 Hz"
1080/59.94p	1080/50p
1080/59.94i	1080/50i
720/59.94p	720/50p

Audio output format HDMI: Linear PCM, 24 bits, 48 kHz, 2 ch

Setting the System Frame Rate

On the P-20HD, the input/output format is determined according to the system frame rate. Set the system frame rate to match the connected equipment.

1. Press the [MENU] button → "System" → select "Frame Rate," and press the [VALUE] knob.

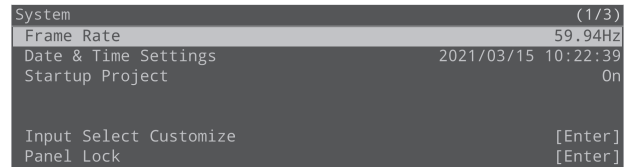

2. Select "59.94 Hz" or "50 Hz," and press the [VALUE] knob.
3. Press the [MENU] button to close the menu.

Internal processing

The internal processing on the P-20HD is progressive. Interlaced input video is automatically converted to a progressive signal. The video might appear jagged at that time, or the video in a PinP inset screen or on the multi-view monitor might blur. This is due to progressive conversion, and is not a malfunction.

Specifying the Input Format (EDID)

With the factory settings, the EDID data is “Internal” (set so that EDID data for all formats that can be inputted is sent). Edit this setting if you want the EDID data for a specific input format to be sent to the source device.

What is EDID?

EDID is data that is transmitted from the P-20HD to the source device when the P-20HD is connected to a source device. EDID contains data such as the formats that can be input to the P-20HD (resolution, color space, color depth) and audio information.

Based on the EDID data that the source device receives, it outputs the most appropriate video format to the P-20HD.

1. Press the [MENU] button → “Video Input” → select “LIVE IN 1” (INPUT 1 connector) or “LIVE IN 2” (INPUT 2 connector), and press the [VALUE] knob.

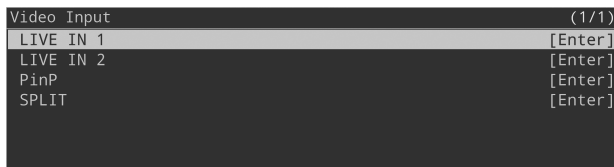

2. Select “EDID,” and press the [VALUE] knob.

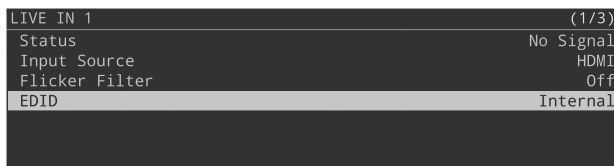

3. Select the input format (EDID), and press the [VALUE] knob.

This switches the input format (EDID).

4. Press the [MENU] button to close the menu.

Setting the Output Format

Here’s how to specify the output format as appropriate for the device that’s connected.

NOTE

If the display does not support the output format of the P-20HD, the video may not play properly.

1. Press the [MENU] button → “Video Output” → select “MAIN OUTPUT,” and press the [VALUE] knob.



2. Select “Output Format” with the [VALUE] knob.

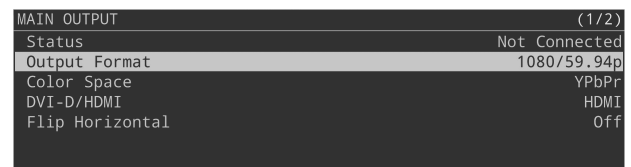

3. Use the [VALUE] knob to select the output format, and press the [VALUE] knob.

The output format switches.

4. Press the [MENU] button to close the menu.

MEMO

About the output format for the OUTPUT PREVIEW connector

- When the annotation feature (p. 36) is off, this is fixed at 1080p.
- When annotation is on, the following formats are used, according to the settings of the OUTPUT MAIN connector format setting.

OUTPUT MAIN connector	OUTPUT PREVIEW connector
1080p	1080p
1080i	1080p
720p	720p

* In either case, the frame rate is determined by the system frame rate settings (p. 12).

Creating a Project

The recorded materials and materials imported from external sources are saved in the SD card in units called projects. Projects are used for creating and managing “clips” that contain specific time ranges of a recorded video, as well as “playlists” that feature multiple clips that are played back in series.

After you turn the P-20HD on, you have the choice to create a new project or open an existing project.

Creating a New Project

Here’s how to create a new project.

1. Press the [MENU] button → “Project” → select “New,” and press the [VALUE] knob.

The New Project screen appears.

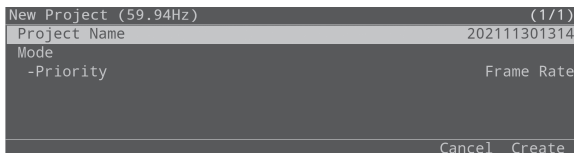

2. Select “Project Name,” and press the [VALUE] knob.
3. Set the project name.

1. Use the [VALUE] knob to move the cursor, and press the [VALUE] knob.

The cursor blinks.



2. Use the [VALUE] knob to edit the character, and press the [VALUE] knob.
 - Hold down the [MENU] button and press the [VALUE] knob to insert a character at the cursor position.
 - Press the [EXIT] button to delete the character at the cursor position.
3. When you finish entering the project’s name, use the [VALUE] knob to select “OK,” and press the [VALUE] knob.

4. Select Mode “Priority,” and press the [VALUE] knob.
5. Select “Resolution” or “Frame Rate,” and press the [VALUE] knob.

Priority	Explanation
Resolution (resolution priority mode)	A recording and playback mode in which resolution is given priority. This is effective for high-definition video.
Frame Rate (frame rate priority mode)	A recording and playback mode in which frame rate is given priority. This is effective for video with rapid motion, such as sporting events.

6. Select “Create,” and press the [VALUE] knob.

A confirmation message appears.
7. Select “OK,” and press the [VALUE] knob.

A new project is created, and the unit returns to the main screen.

MEMO

Projects are saved automatically, so there is no need to save it yourself.

Opening an Existing Project

When you open an existing project, this switches to the current project.

1. Press the [MENU] button → “Project” → select “Open,” and press the [VALUE] knob.

The Open Project screen appears.



2. Select a project to open, and then press the [VALUE] knob.

A confirmation message appears.
3. Select “OK,” and press the [VALUE] knob.

The selected project is loaded, and the unit returns to the main screen.

MEMO

- If “Startup Project” in system settings is set to “On,” the project that was last saved on the SD card is automatically loaded. To switch to another project, open the project using the above operation.
- Even if a project is already open, you can open a new or existing project from [MENU] → “Project” and switch to that project.

Configuring the Project Settings

1. Press the [MENU] button → “Project” → select “Project Settings,” and press the [VALUE] knob.

The Project Settings screen appears.



2. Select a menu item, and press the [VALUE] knob.

* For details on the menu items, refer to “Project Settings” (p. 52).
3. Change the value of the setting, and press the [VALUE] knob.
4. Press the [MENU] button to close the menu.

Video Operations

Recording and Playback

You can play back a previously recorded scene while the P-20HD is recording (chase play).

1. Press the INPUT [SELECT] button to select the input.

Confirm that the video of the input you selected is shown on this unit's display and in the upper left of the monitor connected to the OUTPUT PREVIEW connector.

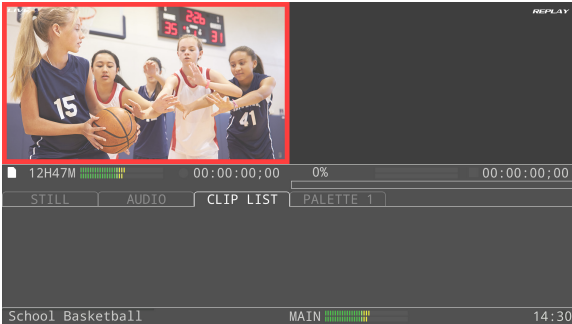

* You can make only the necessary input selectable when you press the INPUT [SELECT] button.

Set the selection to "Enable" or "Disable" for each input in "Input Select Customize" within the SYSTEM menu.

2. Press the [REC] button.

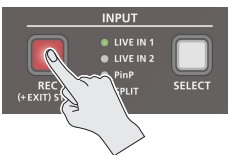

Recording on the SD card begins.

After recording begins, the recorded video (replay video) plays back around one second later on this unit's display and in the upper right of the output preview.

MEMO

- To stop chase play, press the [||] button.
- To resume playback, press the [▶] button.

3. Hold down the [EXIT] button and press the [REC] button.

This stops the recording.

Once recording stops, the playback briefly stops as well, but the unit allows you play back soon afterwards.

NOTE

- Never remove the SD card while recording or playing back.
- Up to 12 hours of video can be recorded per project. Recording stops automatically when the recording time exceeds 12 hours.

Changing the Playback Speed

Use the [SPEED] lever and the [JOG/SHUTTLE] dial to advance through the frames of the video during playback, or to change the playback speed.

MEMO

You can also freely play back video data recorded at a past date and time (scenes that were previously recorded) while recording.

[SPEED] lever

Move the [SPEED] lever back and forth to change the playback speed.

NOTE

The video sound is not played back when you change the playback speed.

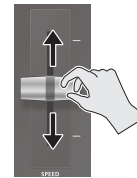

- The playback speed always starts at 100% when you press the [PLAY] button, regardless of the lever position. After playback begins, the speed changes according to how you move the [SPEED] lever.
- Playback begins when you move the lever from the 0% position while playback is paused.

[JOG/SHUTTLE] dial

Use this dial to switch between jog mode (frame advance) and shuttle mode (speed change).

* If the [JOG] button and [SHUTTLE] button are both unlit, operating the dial has no effect.

Jog mode

Press the [JOG] button to enter jog mode (the button lights up).

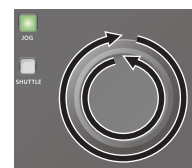

Pauses the instant you turn the dial, and advances by frame.

Clockwise	Frame advance forward
Counterclockwise	Frame advance reverse

There are two operating methods. You can set the frame advance interval for each operation.

- Turn the [JOG/SHUTTLE] dial
Set the frame advance interval in "JOG Speed", Project Settings menu (p. 52).
- Turn the [JOG/SHUTTLE] dial while holding down the [JOG] button
Set the frame advance interval in "[JOG] + Dial", Project Settings menu (p. 52).

Shuttle mode

Press the [SHUTTLE] button to enter shuttle mode (the button lights up).

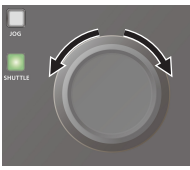

Changes the playback speed according to the angle at which you move the dial.

Turning	To the right	Play forward
	To the left	Play in reverse
Press the dial	Cancels the shuttle mode	

There are two operating methods. You can set the speed factor (maximum value) for each operation.

- **Turn the [JOG/SHUTTLE] dial**
Set the speed factor in "SHUTTLE Speed", Project Settings menu (p. 53).
- **Turn the [JOG/SHUTTLE] dial while holding down the [SHUTTLE] button**
Set the speed factor in "[SHUTTLE] + Dial", Project Settings menu (p. 53).
When in shuttle mode, a gauge is shown on the preview screen that indicates the shuttle dial's angle (the playback speed rate).

Switching Between Videos to Output

The P-20HD lets you seamlessly switch the output between the input video (live in video) and the playback video (replay video).

1. Press the **OUTPUT [LIVE IN] button** or the **OUTPUT [REPLAY] button** to select the video that you want to output.

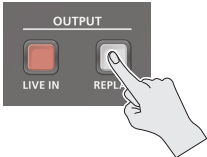

Button	Explanation
OUTPUT [LIVE IN] button	The video of the LIVE IN bus is output from the OUTPUT MAIN connector.
OUTPUT [REPLAY] button	The video of the REPLAY bus is output from the OUTPUT MAIN connector.

Using effects when switching videos (mix/wipe)

You can use effects such as mix or wipe that are applied when switching between videos.

1. Press the [MENU] button → Project "Transition" → select "LIVE IN ► REPLAY" or "REPLAY ► LIVE IN," and press the [VALUE] knob.

* You can also use separate effects for when the live in video switches to the replay video (LIVE IN > REPLAY), and for when the replay video switches to the live in video (REPLAY > LIVE IN).

The Transition screen appears.





2. Select "Time," and press the [VALUE] knob.

3. Set the transition effect switching time and press the [VALUE] knob.

For example, if you set "Time" to one second, the effect takes one second to completely finish after it starts.

4. Select "Type," and press the [VALUE] knob.

5. Select the transition effect and press the [VALUE] knob.

Transition effect	Explanation
Mix	The two videos are mixed as the transition occurs. 
Wipe	The next video moves across to replace the original video. 

6. When wipe has been set in step 5, set this using the menu items shown below.

Menu item	Explanation
Wipe Pattern	Selects the wipe pattern.
Wipe Direction	Selects the wipe direction.

7. Press the [MENU] button to close the menu.

Using Markers (Bookmarks)

On the P-20HD, you can set up to 64 markers in your recorded video data.

You can move between playback positions at which you set the markers, by using the [I◀] [▶I] buttons or by selecting a marker from the marker menu.

* Markers cannot be manipulated while a clip or playlist is playing back.

Setting Markers (Bookmarks)



You can set a marker at the current recording/playback position for recorded video data.

1. Press the [BOOKMARK] button.

A marker is set at the current position.

At this time, the marker's reference time changes according to the status of the [LIVE IN] button.

Press the [LIVE IN] button to switch between lit and unlit status.

[LIVE IN] button status	Explanation
Lit	<p>A marker is set at the current recording position (live in time).</p>  <p>Marker</p>
Unlit	<p>A marker is set at the current playing back position (replay time).</p>  <p>Marker</p>

In either case, a green mark is added to the timeline (indicating that a marker is set).

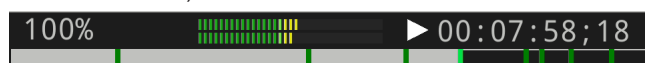

* The marker settings are enabled when the [BOOKMARK] button is lit.

Moving to a Marker (Bookmark) Playback Position

By pressing the marker jump buttons [I◀] [▶I] at a time when the recorded video data can be played back, you can move the playback position from the current position to a previous or following marker.

1. Press the [I◀] or [▶I] button.

The playback position moves to the previous or the following marker.

MEMO

When you press [I◀] but there is no marker before the current playback position, the playback position moves to the beginning of the recorded video data.

When you press [▶I] but there is no marker after the current playback position, the playback position moves to the end of the recorded video data.

MEMO

When you select "Project" → "Marker" from the [MENU] button, all markers are displayed as a list.

Also, when you select a marker and press the [VALUE] knob, the playback position moves to the position of the selected marker.

Adding markers automatically

By setting the auto-marker, you can generate markers automatically at specified intervals during recording.

NOTE

You cannot add more markers than the maximum of 64, including markers placed manually.

1. Press the [MENU] button and select "Project" → "Project Settings" → select "Auto Marker," and press the [VALUE] knob.

Project Settings (1/4)	
Project Name	School Basketball
Mode	
-Priority	Frame Rate
Default Clip Length	7.0sec
Auto Marker	Off
Playback Audio Source	REPLAY

2. Set the auto-marker interval, and press the [VALUE] knob.

For the marker interval, you can specify a time within 1–60 minutes, in units of one minute.

3. Press the [MENU] button to close the menu.

MEMO

When you want to record more material to a project that already contains recorded video data, a marker is automatically added to the recording start point regardless of the auto-marker settings.

Deleting a Marker (Bookmark)

- 1. Press the [◀] or [▶] button to move the current position to the location of the marker that you want to delete.**
- 2. Press the [DELETE] button.**

The marker at the current position is deleted.

* Markers can only be deleted when the [DELETE] button is lit (when there is a marker at the playback position).

Using Clips

With the P-20HD, you can specify a certain time range of a recorded video and use it to create a clip. The clips you create can be used as material for replay.

Once you create clips of highlight scenes from recorded video, you can play back these video clips at whatever timing you like.

Use the following methods to specify the time ranges.

- Specify a time range while watching the video, and create the clip
- Create the clip based on the current recording/playback position

Creating a Clip

Specify a time range while watching the video, and create the clip

You can specify a time range within a recorded video and turn it into a clip.

By combining this with playback operation of the clip, you can play back video from the time range you like at the timing you desire.

1. With content having been recorded (now recording, or recording stopped), press the [▶] button to start playback.

At this time, check that the MARKER [LIVE IN] button is unlit. Once the MARKER [LIVE IN] button lights, press the button again to make it go dark.



Specify the IN point (the beginning of the time range).

Make sure that the MARKER [IN] button is lit.

2. Press the MARKER [IN] button.



A light blue marker is shown on the timeline, and the button goes dark.



The time at which you press the MARKER [IN] button marks the start of the time range.

Specify the OUT point (the end of the time range).

The MARKER [OUT] button lights up one second after the video progresses from the IN point that you set. Make sure that the MARKER [OUT] button is lit.

3. Use the [▶] button or the [JOG/SHUTTLE] dial to move the video forward.

4. Press the MARKER [OUT] button at the position where you want to end the time range.

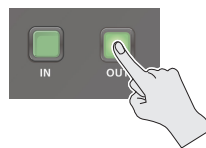

The button goes dark, and a clip is created.

A light blue marker is erased on the timeline.

The clips you create are registered in the clip list.

NOTE

- You can't make clips shorter than one second. A clip is not made if you press the [OUT] button within an IN/OUT range that is shorter than one second. Once the [OUT] button lights up, you can make a clip.
- You can't set the OUT point earlier than the IN point.
- The time that is actually set when you press the [IN] or [OUT] buttons may be a little off compared to the time you specified, depending on when you push the buttons.

MEMO

If the MARKER [LIVE IN] button in step 1 is lit, a clip is created based on the live in time (the current time of recording). In this case, the IN/OUT points are set to the recording positions at the times they are pressed. For example, when you press [IN] and then press [OUT] three seconds later, the three seconds recorded between IN and OUT are turned into a clip.

Create the clip based on the current recording/playback position

It's easy to create a clip by specifying only the OUT point.

By combining this with playback operation of the clip, you can instantly replay what happened immediately before. This is convenient when you want to keep the game play that just happened as a clip, such as when players score points in a live sporting event.

1. With content having been recorded (now recording, or recording stopped), press the [▶] button to start playback.

At this time, check that the MARKER [LIVE IN] button is lit. If the MARKER [LIVE IN] is unlit, press the button again to make it light.

2. Press the MARKER [MAKE CLIP] button where you want to set the end of the time range.

A seven-second clip of recorded video is created whose time range ends at the position where you pressed the button, and the clip is registered in the clip list.

NOTE

- You can't perform this operation if the recording time has not reached the time set for the clip and the [MAKE CLIP] button is dark.
- The IN/OUT points for the clip may be little off compared to the times you specified, depending on when you press the [MAKE CLIP] button.

MEMO

- If the MARKER [LIVE IN] button in step 1 is unlit, you can create a clip whose replay position is at the end of the time range, not based on the current time of recording.
- When you create a clip using MAKE CLIP, the playback position jumps to the IN point to create a thumbnail. After the clip is created, the playback position returns to its previous position. If OUTPUT is set to REPLAY, playback does not jump to the IN point and a thumbnail is not created, to avoid adversely affecting the REPLAY output. A temporary thumbnail is created for the clip.
- You can select clips you create by using the pads, or execute the "Update Thumbnails" operation from the menu to display the thumbnails.

Changing the length of a clip to create

You can change the length of the clip to create (the default value is 7 seconds).

MEMO

The setting is saved on a per-project basis.

1. Press the [MENU] button → "Project" → "Project Settings" → select "Default Clip Length," and press the [VALUE] knob.

Project Settings (1/4)	
Project Name	School Basketball
Mode	
-Priority	Frame Rate
Default Clip Length	7.0sec
Auto Marker	Off
Playback Audio Source	REPLAY

2. Change the clip length, and press the [VALUE] knob.
3. Press the [MENU] button to close the menu.

Playing Back a Clip

You can easily play back the clips you create.

1. Press the [CLIP LIST] button.



The CLIP LIST screen is shown on the bottom half of this unit's display.

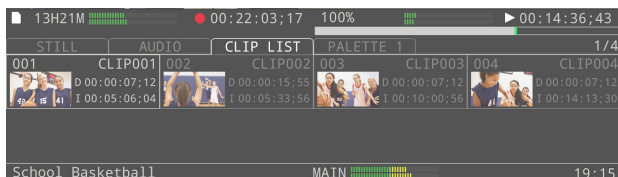

2. Press the pad corresponding to the clip you want to play back.

The clip is selected, and the replay video stops at the video of the selected clip's IN point.

A thumbnail of the clip is created at this timing if it is not shown.

MEMO

- You can use the [VALUE] knob to select the clip you want to play back from the clip list.
- Press the [<] [>] buttons to switch between the clip ranges (pages) shown on this unit's display.

3. Press the AUTO PLAY [CLIP] button.



The clip plays back when the output is switched to the replay side.

When the clip finishes playing back, the OUTPUT videos (LIVE IN and REPLAY) automatically return to how they were prior to playback.

NOTE

- You can't use the [SPEED] lever or [JOG/SHUTTLE] dial to change the playback speed (with the lever, jog or shuttle operations) when playing back a clip.
- When you press the [CLIP] button before pressing a pad, the video selected by the cursor plays back at the time you pressed the button.

Playing back a playlist

1. Press the [CLIP LIST] button to display the CLIP LIST screen.

2. Press the AUTO PLAY [PLAYLIST] button.

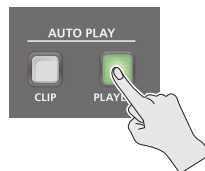

All registered clips in the clip list from the first clip to the last clip play back in series.

As with the playback of clips, clips are played back by switching the output to the replay side.

When the last clip finishes playing back, the OUTPUT videos automatically return to how they were (LIVE IN and REPLAY) prior to playback.

NOTE

You can't use the [SPEED] lever or [JOG/SHUTTLE] dial to change the playback speed (with the lever, jog or shuttle operations) when playing back a playlist.

Editing a Clip

You can change a clip's parameters after it is created.

- * You can't edit clips during playback.

Displaying the CLIP MENU screen

Access the CLIP MENU screen from the CLIP LIST or PALETTE screen.

1. Turn the [VALUE] knob to select the desired clip, and press the [VALUE] knob

The CLIP MENU screen appears.



Editing a Clip's Name

Clips can be renamed.

1. On the CLIP LIST (PALETTE) screen, select the clip to display the CLIP MENU screen.

2. Select "Name" and press the [VALUE] knob.

3. Edit the clip name.

- * Clip names can contain up to 10 characters.

1. Use the [VALUE] knob to move the cursor, and press the [VALUE] knob.

The cursor blinks.



2. Use the [VALUE] knob to edit the character, and press the [VALUE] knob.

- Hold down the [MENU] button and press the [VALUE] knob to insert a character at the cursor position.
- Press the [EXIT] button to delete the character at the cursor position.

4. When you finish entering the clip's name, use the [VALUE] knob to select "OK," and press the [VALUE] knob.

NOTE

If the clip list is referring to a palette, changing the clip name here also changes the clip to which it refers.

Changing the length of a clip

You can edit the "In Position" and "Out Position" parameters of a clip to change its start position, end position and length.

1. On the CLIP LIST (PALETTE) screen, select the clip to display the CLIP MENU screen.



2. Use the [▶] button and the [JOG/SHUTTLE] dial to move the recording data to the position you want to set as the IN point.

3. Press the MARKER [IN] button to set the IN point.

- * You can't set the IN point later than the OUT point.

4. Using the operations in step 2, move to the position you want to set as the OUT point.

5. Press the MARKER [OUT] button to set the OUT point.

- * You can't set the OUT point before the IN point.

- * You can't set the OUT point less than one second after the IN point.

- * In some circumstances, the IN/OUT points may be slightly off compared to the positions you specified.

Changing the thumbnail position

You can specify the thumbnail position and change the thumbnail of a clip.

1. On the CLIP LIST (PALETTE) screen, select the clip to display the CLIP MENU screen.

2. Use the [▶] button and the [JOG/SHUTTLE] dial to move the recording data to the position you want to set as the thumbnail.

3. Select "Update Thumbnail" and press the [VALUE] knob.

The image at the position you moved to becomes the thumbnail.

- * In some circumstances, the thumbnail may be in a slightly different position than the one you specified.

Registering a clip to a palette

This is explained in "Registering a Clip to a Palette" (p. 25).

Sorting a clip

This is explained in "Sorting Clips" (p. 24).

Deleting a Clip

Here's how to delete clips you don't need from the list.

- 1. On the CLIP LIST screen, select the clip to display the CLIP MENU screen.**
- 2. Select "Delete" and press the [VALUE] knob.**
- 3. A dialog appears, select "OK," and press the [VALUE] knob.**

The clip is deleted, and the menu closes.

- * A confirmation message appears when deleting a clip registered to a palette.

Clip List Operations

Creating a Thumbnail

You can create thumbnails for many clips all at once that do not yet have a thumbnail.

* The playback position jumps to the IN point to create a thumbnail.

1. Press the [MENU] button → “Pad” → select “CLIP LIST,” and press the [VALUE] knob.
The clip list menu screen appears.
2. Select “Create Thumbnails” and press the [VALUE] knob.
3. A dialog appears, select “OK,” and press the [VALUE] knob.
This creates thumbnails for clips that do not yet have a thumbnail.

Initializing the Clip List

You can initialize the contents of the clip list.

NOTE

When you initialize the contents of a clip list, all clips registered in that list are deleted. The clips registered in the palette are deleted as well.

1. Press the [MENU] button → “Pad” → select “CLIP LIST,” and press the [VALUE] knob.
The clip list menu screen appears.
2. Select “Clear All” and press the [VALUE] knob.
A confirmation message appears.
3. Select “OK,” and press the [VALUE] knob.
The clip list is now initialized.

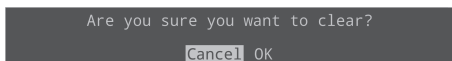

* If you decide to cancel, press the [EXIT] button.

Adding Transition Effects

You can add transition effects between clips when playing back a playlist.

1. Press the [MENU] button → select “Playlist,” select the clip list or palette you want to set, and press the [VALUE] knob.



2. Select a menu item shown below, and press the [VALUE] knob.

Menu	Explanation
Transition	
Time	Sets the transition effect time.
Type	Selects the type of transition effect.

3. Change the value of the setting, and press the [VALUE] knob.
4. Press the [MENU] button to close the menu.
* For details on the menu items, refer to “3: Playlist” (p. 54).

Sorting Clips

You can sort the playlists or the clips within a palette.

1. On the CLIP LIST (PALETTE) screen, select the clip to display the CLIP MENU screen.
2. Select “Move to” and press the [VALUE] knob.
This displays the clip list.
3. Use the [VALUE] knob to select the destination, and press the [VALUE] knob.
4. Select “Move,” and press the [VALUE] knob.
* Choose “Select” to once again specify the destination. Select “Cancel” to discard the sorting and return to the previous screen.

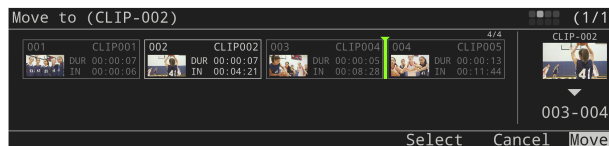

A confirmation message appears.

5. Select “OK,” and press the [VALUE] knob.
This confirms the sorting.

Pad Operations

Using the Palettes

On the P-20HD, you can register the clips you have created in eight different palettes and categorize the clips by player, scene and so on according to your tastes.

You can also play back the clip list and clips arranged in a palette in series (This is the playlist playback feature).

Further, you can play back highlights during an event or an ending.

Registering a Clip to a Palette

1. Press the [CLIP LIST] button

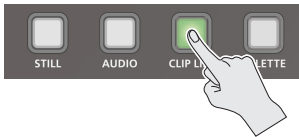

2. Use the [VALUE] knob or press the pads to select the clip you want to register, and press the [VALUE] knob.

The CLIP MENU screen appears.



3. Select "Add to PALETTE," and press the [VALUE] knob.

The [PALETTE] button and pads [1]–[8] blink.

4. Press the same pad number as the palette to which you want to register (for example, press pad [3] to register to palette 3).

5. Select "OK," and press the [VALUE] knob.

The clips are now registered in the palette.

6. Hold down the [PALETTE] button and press the pad you pressed in step 4.

The palette switches to the one in which you just registered the clip.

MEMO

The operation for playing back clips in the PALETTE screen is the same as with the CLIP LIST screen.

Selecting a Palette

1. Hold down the [PALETTE] button and press pads [1]–[8].

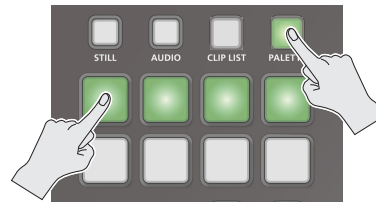

The palette corresponding to the pad you pressed is selected.

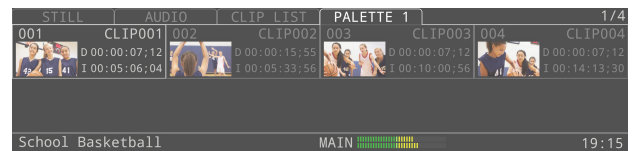

- * If you press only the [PALETTE] button, the palette that was last displayed is selected.
- * If you hold down just the [PALETTE] button, the pad corresponding to the selected palette number lights up. Also, the number of the selected palette is shown in the palette tab onscreen.

Playing Back a Playlist

1. Hold down the [PALETTE] button and press pads [1]–[8] to display the PALETTE screen.

2. Press the AUTO PLAY [PLAYLIST] button.

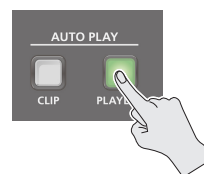

The clips in the selected palette play back in series, from the first registered clip to the last.

As with the playback of clips, clips are played back by switching the output to the replay side.

When the last clip finishes playing back, the OUTPUT videos automatically return to how they were (LIVE IN and REPLAY) prior to playback.

NOTE

You can't use the [SPEED] lever or [JOG/SHUTTLE] dial to change the playback speed (with the lever, jog or shuttle operations) when playing back a playlist.

Editing Clips in a Palette

If a clip in the clip list is referring to a clip registered to a palette, changing the contents of the clip also changes the clip to which it refers.

* You can't edit clips during playback.

Editing a clip's name

This is explained in "Editing a Clip's Name" (p. 22).

Changing the length of a clip

This is explained in "Changing the length of a clip" (p. 22).

Changing the thumbnail position

This is explained in "Changing the thumbnail position" (p. 22).

Deleting clips in a palette

1. On the PALETTE screen, use the [VALUE] knob or press a pad to select the clip.

The CLIP MENU screen appears.

PALETTE-1 CLIP-01 (1/2)	
Name	CLIP001
In Position	00:05:06;02
Out Position	00:05:13;14
Duration	00:00:07;12
Update Thumbnail	[Exec]
Color	Red

2. Select "Delete," and press the [VALUE] knob.

A confirmation message appears.

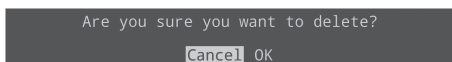

* If you decide to cancel, press the [EXIT] button.

3. Select "OK," and press the [VALUE] knob.

The clips are now deleted from the palette.

However, clips that are in a clip list still remain.

Other Palette Operations

Creating a Thumbnail

You can create thumbnails for many clips all at once that do not yet have a thumbnail.

* The playback position jumps to the IN point in order to create a thumbnail.

1. Press the [MENU] button → "Pad" → select "PALETTE," and press the [VALUE] knob.

The menu screen for the selected palette appears.

2. Select "Create Thumbnails," and press the [VALUE] knob.

3. A dialog appears, select "OK," and press the [VALUE] knob.

This creates thumbnails for clips that do not yet have a thumbnail.

Initializing a Palette's Contents

You can initialize the contents of a palette.

NOTE

When you initialize the contents of a palette, all clips registered in that list are deleted from the palette (Note that clips that are in a clip list still remain).

1. Press the [MENU] button → "Pad" → select "PALETTE," and press the [VALUE] knob.

The menu screen for the selected palette appears.

2. Select "Clear All" and press the [VALUE] knob.

A confirmation message appears.

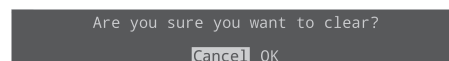

* If you decide to cancel, press the [EXIT] button.

3. Use the [VALUE] knob to select "OK," and press the [VALUE] knob.

The palette is initialized.

Changing the Pad Illumination Colors

You can change the colors in which the pads light up.

1. Press the [MENU] button → "Pad" → select "PALETTE," and press the [VALUE] knob.

The menu screen for the selected palette appears.

2. Select "Pad Color" and press the [VALUE] knob.

3. Turn the [VALUE] knob to select the color and press the [VALUE] knob.

Using Still Images

You can import still images created on your computer as materials and display those images by pressing the pads.

You can overlay still images you have imported onto a video.

Supported files

Format	Bitmap file (.bmp), 24-bit color, uncompressed
	PNG file (.png), 24-bit color, 8-bit with alpha channel
File name	Must be single-byte alphanumeric characters, up to 32 characters long including the extension. * The extension (".bmp" or ".png") must be added.
Size	1920 x 1080 pixels
No. of images	Max. of 16 per project

* The dimensions of the still image file you use should be 1920 x 1080 pixels.

Importing a Still Image

To begin, save the material files for the still images that you created on your computer beforehand to the root directory of your USB storage device.

1. Connect the USB storage device containing your materials to the USB 3.0 port of this unit.

2. Press the [STILL] button.

The STILL screen is shown.

3. Turn the [VALUE] knob to move the cursor to the position of the still image clip to import.

4. Press the [VALUE] knob.

The Still Image clips menu screen appears.

5. Select "Import" and press the [VALUE] knob.

The Import Still Image screen appears.



Import Still Image (STILL-01)		
Championship.bmp	310KB	2021/04/06 01:21
Highlights.png	24KB	2021/04/06 01:04
LiveSports.png	91KB	2021/04/06 22:13
Opening.bmp	65KB	2021/04/06 01:14
TeamA.png	98KB	2021/04/06 17:44
TeamB.png	94KB	2021/02/26 22:23

6. Select the file to import, and press the [VALUE] knob.

7. A dialog appears, select "OK," and press the [VALUE] knob.

The import begins, and the still image clips are arranged on the screen. The pads that correspond to still images that were imported light up yellow.

Playing Back Still Image Clips

1. Press the [STILL] button.

2. Press a pad from [1]–[8] corresponding to the position of the still image clip you want to play back.

This displays the still image clip.

MEMO

- You can individually set the effects applied when images are displayed from the STILL screen menu.
- Still images are layered on top of the video and output.
- The still image is not displayed by the Preview Bus (display of this unit, PREVIEW output). Check the image at the Main Bus output.

Setting a Still Image Clip

For still image clips that are assigned to the pads, you can individually configure the playback-related settings.

1. Press the [STILL] button.
2. Turn the [VALUE] knob to move the cursor and select the still image clip.
3. Press the [VALUE] knob.

The still image clip setting screen is displayed.



4. Select a menu item shown below, and press the [VALUE] knob.

Menu	Explanation
Import	Imports the still image.
Name	Sets the name of the still image clip.
File	Shows the filename (display only).
Alpha Channel	Shows whether the image has an alpha channel (display only).
On/Off	Sets what happens when the still image plays back.
In Transition	Sets the type of effect used when displaying the still image.
Time	Sets the time used when the still image plays back.
Direction	Sets the direction of motion used when the still image plays back. * When "In Transition" is set to "Fade," no effect is applied.
Out Transition	Sets the type of effect used when wiping the still image.
Time	Sets the time used when wiping the still image.
Direction	Sets the direction of motion used when wiping the still image. * When "Out Transition" is set to "Fade," no effect is applied.
Swap with	Swaps the position of still image clips. <ol style="list-style-type: none"> 1. Select "Swap with" and press the [VALUE] knob. This displays the still image clip list. 2. Select the destination, and press the [VALUE] knob. 3. Select "Swap," and press the [VALUE] knob. A confirmation message appears. 4. Select "OK," and press the [VALUE] knob. This confirms the swap.
Delete	Deletes the still image clip.
Color	Set the color of the label that's shown in the still image clip.

* For details on the menu items, refer to "STILL" (p. 67).

5. Change the value of the setting and execute the operation.

6. Press the [MENU] button to close the menu.

Using Audio Files

Audio files that you created on your computer can be imported into the P-20HD as materials. The imported audio can then be played back by pressing the pads.

Supported files

Format	WAV (linear PCM, 48 kHz, 16-bit, stereo/ 44.1 kHz, 16-bit, stereo)
File name	Must be single-byte alphanumeric characters, up to 32 characters long including the extension. The extension (".wav") must be added.
No. of files	Max. of 16 per project

Importing an Audio File

To begin, save the audio files (materials) you created on your computer to the root directory of a USB storage device.

1. **Connect the USB storage device containing your materials to the USB 3.0 port of this unit.**
2. **Press the [AUDIO] button**
The AUDIO CLIP MENU screen is shown.
3. **Use the [VALUE] knob to move the cursor to the position of the audio clip to import.**
4. **Press the [VALUE] knob.**
The audio clip setting screen is displayed.
5. **Select "Import" and press the [VALUE] knob.**
The Import Audio screen appears.
6. **Select the files you want to import, and press the [VALUE] knob.**
7. **A dialog appears, select "OK," and press the [VALUE] knob.**
The import begins, and the audio clips are arranged on the screen.

Playing Back Audio Clips

1. **Press the [AUDIO] button**
2. **Press a pad from [1]–[8] corresponding to the position of the audio clip you want to play back.**
The audio clip plays back.

MEMO

You can individually set the loop, volume and so on from the menu in the AUDIO CLIP MENU screen.

Setting an Audio Clip

1. **Press the [AUDIO] button**
2. **Turn the [VALUE] knob to move the cursor and select the audio clip.**
3. **Press the [VALUE] knob.**
The audio clip setting screen is displayed.

Menu	Explanation
Import	Imports the audio.
File	Shows the audio file name.
Name	Shows the audio clip name.
Duration	Shows the audio clip length.
Level	Sets the volume of the audio clip.
On/Off	Sets what happens when the audio clip plays back.
Offset	Sets the playback start position of the audio clip.
Fade In	Sets the fade-in time.
Fade Out	Sets the fade-out time.
Loop	When this is set to "On," the audio clip plays back in a loop.
Swap with	Swaps audios.
Delete	Deletes the audio.
Color	Set the color of the label that's shown in the audio clip.

4. **Select a menu item shown below, and press the [VALUE] knob.**

Menu	Explanation
Import	Imports the audio.
File	Shows the audio file name.
Name	Shows the audio clip name.
Duration	Shows the audio clip length.
Level	Sets the volume of the audio clip.
On/Off	Sets what happens when the audio clip plays back.
Offset	Sets the playback start position of the audio clip.
Fade In	Sets the fade-in time.
Fade Out	Sets the fade-out time.
Loop	When this is set to "On," the audio clip plays back in a loop.
Swap with	Swaps audios. 1. Select "Swap with" and press the [VALUE] knob. This displays the audio clip list. 2. Select the destination, and press the [VALUE] knob. 3. Select "Swap," and press the [VALUE] knob. A confirmation message appears. 4. Select "OK," and press the [VALUE] knob. This confirms the swap.
Delete	Deletes the audio.
Color	Set the color of the label that's shown in the audio clip.

* For details on the menu items, refer to "AUDIO" (p. 67).

5. **Change the value of the setting and execute the operation.**
6. **Press the [MENU] button to close the menu.**

Adjusting the Video

Adjusting Output Video

Here's how to adjust the output video so that it is appropriate for the device that receives output from the P-20HD.

MEMO

You can output a test pattern, which is useful for adjusting the image quality of a display.

Press the [MENU] button → "System" → "Test Pattern" to select the test pattern.

1. Press the [MENU] button → "Video Output" → select "MAIN OUTPUT" or "PREVIEW OUTPUT," and press the [VALUE] knob.



2. Select a menu item shown below, and press the [VALUE] knob.



Menu	Explanation
Status	Shows the status of the OUTPUT jacks. If there is no connection, "Not Connected" is shown.
Output Format (only for MAIN OUTPUT)	Sets the output format.
Output Assign (only for PREVIEW OUTPUT)	Specifies the output bus that is assigned to the PREVIEW OUTPUT.
Color Space	Specifies the color space.
DVI-D/HDMI	Specifies the output mode.
Flip Horizontal (only for MAIN OUTPUT)	If this is set to "On," the video is output with left and right flipped.
Brightness	Adjusts the brightness.
Contrast	Adjusts the contrast.
Saturation	Adjusts the saturation.
Red	Adjusts the red level.
Green	Adjusts the green level.
Blue	Adjusts the blue level.

* For details on the menu items, refer to "7: Video Output" (p. 57).

3. Adjust the output video and press the [VALUE] knob.
4. Press the [MENU] button to close the menu.

Adjusting the Input Video

Here's how to adjust the video that is input from the INPUT 1 and 2 connectors.

1. Press the [MENU] button → "Video Input" → select "LIVE IN 1" or "LIVE IN 2," and press the [VALUE] knob.

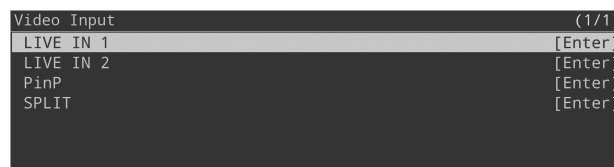

2. Select a menu item shown below, and press the [VALUE] knob.



Menu	Explanation
LIVE IN 1, 2	
Status	Displays information about the input video (video format, size, etc.).
Input Source	Selects the input source.
Flicker Filter	If this is set to "On," flickering is reduced.
EDID	Specifies the input format (EDID).
Zoom	Adjusts the zoom ratio.
Scaling Type	Specifies the scaling type.
Manual Size H	Adjusts the horizontal size.
Manual Size V	Adjusts the vertical size.
Position H	Adjusts the horizontal position.
Position V	Adjusts the vertical position.
Brightness	Adjusts the brightness.
Contrast	Adjusts the contrast.
Saturation	Adjusts the saturation.
Red	Adjusts the red level.
Green	Adjusts the green level.
Blue	Adjusts the blue level.

PinP	
Background Ch	Sets the channel for the background video of the inset screen.
Window Ch	Sets the channel for the video of the inset screen.
Window Pos H	Adjusts the horizontal position of the inset screen.
Window Pos V	Adjusts the vertical position of the inset screen.
Window Aspect	Sets the aspect ratio of the inset screen.
Window Size	Adjusts the size (zoom) of the inset screen.
Window Crop H	Adjusts the horizontal size of the inset screen.
Window Crop V	Adjusts the vertical size of the inset screen.
View Pos H	Adjusts the horizontal position at which the inset screen video is shown.
View Pos V	Adjusts the vertical position at which the inset screen video is shown.
View Zoom	Adjusts the zoom of the inset screen video.

Border Color	Sets the border color for the inset screen video.
Border Width	Sets the border width for the inset screen video.

SPLIT	
Pattern	Sets the split composite pattern.
Center	Sets the split position.
A-Ch(Left/Upper)	Sets the channel for the left/upper split video.
B-Ch(Right/Lower)	Sets the channel for the right/lower split video.
A-Center	Adjusts the horizontal/vertical position of the left/upper split video.
B-Center	Adjusts the horizontal/vertical position of the right/lower split video.
Border Color	Sets the border color for the split.
Border Width	Sets the border width for the split.

* For details on the menu items, refer to “6: Video Input” (p. 55).

3. Adjust the input video and press the [VALUE] knob.
4. Press the [MENU] button to close the menu.

Switching between input video (LIVE IN 1/LIVE IN 2/ PinP/SPLIT)

1. Press the INPUT [SELECT] button.



Each time you press the button, the video switches in this order: “LIVE IN 1” → “LIVE IN 2” → “PinP” → “SPLIT” → “LIVE IN 1.”

MEMO

- You can directly switch the input video by holding down the [EXIT] button and pressing the INPUT [SELECT] button several times, and then releasing the [EXIT] button after you’ve selected the desired video.
- You can make only the necessary input selectable when you press the INPUT [SELECT] button.

Set the selection to “Enable” or “Disable” for each input in “Input Select Customize” within the SYSTEM menu.

Assigning the Output Buses

The P-20HD features three internal output buses (Main, Preview and Replay).

You can set which output bus is assigned to the PREVIEW OUTPUT connector.

1. Press the [MENU] button → “Video Output” → select “PREVIEW OUTPUT,” and press the [VALUE] knob.



2. Select “Output Assign,” and press the [VALUE] knob.



3. Select the output bus, and press the [VALUE] knob.
4. Press the [MENU] button to close the menu.

Audio Operations

Adjusting the Volume

Here's how to adjust the volume of the input and output audio.

1. Press the [MENU] button → “Audio Input” → select a value from “LIVE IN 1” to “AUDIO PLAYER,” and press the [VALUE] knob.



2. Select “Level,” and press the [VALUE] knob.
3. Adjusts the input volume, and press the [VALUE] knob.
4. Press the [MENU] button.
5. Press the [MENU] button → “Audio Output” → select “Main Bus” or “Preview Bus,” and press the [VALUE] knob.

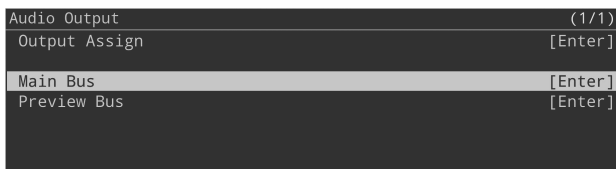

6. Select “Level,” and press the [VALUE] knob.
7. Adjusts the output volume, and press the [VALUE] knob.
8. Press the [MENU] button to close the menu.

Level meter display

The colors on the level meter help you to check whether the volume is adjusted appropriately.

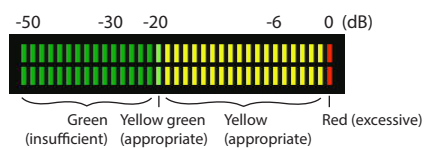

Lit color	Status
Red	Lights up at 0 dB or higher. This indicates an excessive volume level.
Yellow	Lights up at -19 to -1 dB. This indicates an appropriate volume level.
Yellow green	Lights up at -20 dB. This indicates an appropriate volume level.
Green	Lights up at -50 to -21 dB. This indicates that the volume is too low.

* If the speaker output volume is not where it should be even after you've adjusted the levels so that the level meters light up yellow, try adjusting the volume on your speakers or amp. Adjusting the levels using the “OUTPUT LEVEL” parameter may distort or degrade the audio signal.

Applying Effects to the Input Audio

You can apply effects to the input audio to adjust the character of the sound.

1. Press the [MENU] button → “Audio Input” → select “LIVE IN 1,” “LIVE IN 2” or “AUDIO IN,” and press the [VALUE] knob.



2. Select the menu item of the effect, and press the [VALUE] knob.

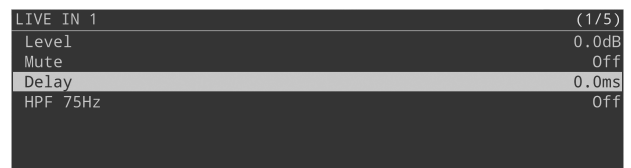

3. Edit the setting value, and press the [VALUE] knob.
4. Press the [MENU] button to close the menu.

Delay

Delays the audio output.

Use this effect to delay the output of the audio, making the timing of the video and audio match.

Menu	Explanation
Delay	Adjusts the delay time of the audio.

High-pass filter (HPF, 75 Hz)

Cuts off unneeded low-band audio. The cutoff frequency is 75 Hz.

Menu	Explanation
HPF 75 Hz	Turns the high-pass filter on/off.

Noise gate (Gate)

Eliminates unwanted background noise.

Menu	Explanation
Gate	Turns the noise gate on/off.
Threshold	Specifies the base level used as the threshold for removing audio. Audio below the level set here is removed.
Release	Adjusts the length of time until the audio is fully attenuated after the audio level falls below the threshold.

Equalizer (EQ)

Adjusts the tonal character of the audio for each frequency band.

Menu	Explanation
EQ	Turns the equalizer on/off.
Hi Gain	Boosts or attenuates the high band.
Hi Freq	Adjusts the center frequency when changing the tonal character of the high band.
Mid Gain	Boosts or attenuates the midrange band.
Mid Freq	Adjusts the center frequency when changing the tonal character of the midrange band.
Mid Q	Adjusts the frequency bandwidth when boosting or attenuating the midrange band.
Lo Gain	Boosts or attenuates the low band.
Lo Freq	Adjusts the center frequency when changing the tonal character of the low band.

Compressor

Audio that exceeds the specified threshold level is compressed.

Menu	Explanation
Compressor	Turns the compressor on/off.
Threshold	Specifies the base level at which the compressor is applied. Compression is applied to audio that exceeds the threshold.
Ratio	Specifies the degree of compression applied to the audio. The ratio used when no compression is applied is defined as "1."
Attack	Specifies the time until compression starts when audio exceeding the threshold is input.
Release	Adjusts the length of time until compression ends after audio falls below the threshold.
Makeup Gain	Adjusts the final output volume level after applying the compressor.

Applying Effects to Output Audio

Here's how to modify the tonal character by applying effects to the audio output.

1. Press the [MENU] button → "Audio Output" → select "Main Bus" or "Preview Bus," and press the [VALUE] knob.
2. Select the menu item of the effect, and press the [VALUE] knob.

* The effects that can be used depend on the bus you select. For details on the effects, see the next page.

Input	Effect that can be used
Main Bus	Delay, Limiter, EQ
Preview Bus	Delay, Limiter

3. Edit the setting value, and press the [VALUE] knob.
4. Press the [MENU] button to close the menu.

Delay

Delays the audio output.

Use this effect to delay the output of the audio, making the timing of the video and audio match.

Menu	Explanation
Delay	Adjusts the delay time of the audio.

Limiter

Limits the output level so that it doesn't exceed the level you specify.

Menu	Explanation
Limiter	Turns the limiter on/off.
Threshold	Specifies the base level at which the limiter is applied. Compression is applied to audio that exceeds the threshold. The volume level of audio that is output is limited so as to stay to below the threshold.

Equalizer (EQ)

Adjusts the tonal character of the audio for each frequency band.

Menu	Explanation
EQ	Turns the equalizer on/off.
Hi Gain	Boosts or attenuates the high band.
Hi Freq	Adjusts the center frequency when changing the tonal character of the high band.
Mid Gain	Boosts or attenuates the midrange band.
Mid Freq	Adjusts the center frequency when changing the tonal character of the midrange band.
Mid Q	Adjusts the frequency bandwidth when boosting or attenuating the midrange band.
Lo Gain	Boosts or attenuates the low band.
Lo Freq	Adjusts the center frequency when changing the tonal character of the low band.

Muting Only Specific Audio (Mute)

Here's how to temporarily mute specific input or output audio (Mute function).

Muting input audio

1. Press the [MENU] button → “Audio Input” → select an item from “LIVE IN 1” to “AUDIO PLAYER,” and press the [VALUE] knob.



2. Select “Mute,” and press the [VALUE] knob.



3. Select “On,” and press the [VALUE] knob.
4. Press the [MENU] button to close the menu.

Muting Output Audio

1. Press the [MENU] button → “Audio Output” → select “Main Bus” or “Preview Bus” and press the [VALUE] knob.
2. Select “Mute,” and press the [VALUE] knob.



3. Select “On,” and press the [VALUE] knob.
4. Press the [MENU] button to close the menu.

Switching Between Audio Output from Each Output Connector

The P-20HD features two internal audio output buses (Main and Preview).

You can set which audio output bus is assigned to each output connector.

1. Press the [MENU] button → “Audio Output” → select “Output Assign,” and press the [VALUE] knob.

The menu related to output audio is shown.



2. Select “PREVIEW OUT,” “AUDIO OUT” or “PHONES OUT,” and press the [VALUE] knob.

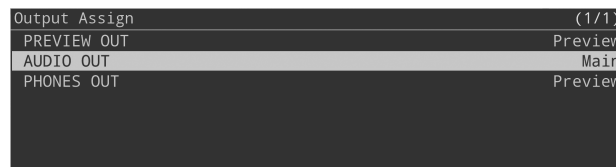

3. Select the output bus, and press the [VALUE] knob.
4. Press the [MENU] button to close the menu.

Mixing the AUDIO IN Audio with the Audio from the Video

With the P-20HD, you can mix the audio from AUDIO IN with one of the following audio signals.

- Audio from input video
- Audio from final output

Mixing the AUDIO IN Audio with the Audio from the Input Video

Here's how to mix the audio signal from the AUDIO IN with the audio signal from the Live In video.

This lets you record narration at the same time as you record the video.

1. Select "AUDIO INPUT" → "AUDIO IN" → "Send To" → "Live In Bus" from the [MENU] button, and press the [VALUE] knob.

AUDIO IN	(1/5)
Level	0.0dB
Mute	Off
Delay	0.0ms (0.0Frame)
HPF 75Hz	Off
Send To	Live In Bus

Mixing the AUDIO IN Audio with the Audio from the Final Output

Here's how to mix the audio signal from the AUDIO IN with the audio signal that's output from the P-20HD.

You can use this feature for adding commentary audio during video replay.

1. Select "AUDIO INPUT" → "AUDIO IN" → "Send To" → "Input Bus" from the [MENU] button, and press the [VALUE] knob.

AUDIO IN	(1/5)
Level	0.0dB
Mute	Off
Delay	0.0ms (0.0Frame)
HPF 75Hz	Off
Send To	Input Bus

Annotation

On this unit, you can use the annotation feature to draw handwritten letters, arrows and other objects on the video image. By connecting a commercially available pen tablet to the P-20HD, you can draw on the pen tablet and composite what you draw with the video. As the P-20HD lets you switch between live and replay video, you can composite your drawing with either type of video.

Supported pen tablets

This unit supports the use of commercially available pen displays and pen tablets.

Refer to the support page on the Roland website for the latest information on which models are compatible.

<https://roland.cm/p-20hd>

Connecting a Pen Display/ Pen Tablet

See the Owner's Manual of your pen tablet for the connections you need to make with the pen tablet.

Connecting to a Pen Display

When using a pen display with this unit, you can draw on the video image while looking at it on the pen display, and composite the image with what you draw.

Use the cable included with your pen display and connect the pen display to the P-20HD as shown in the illustration below.

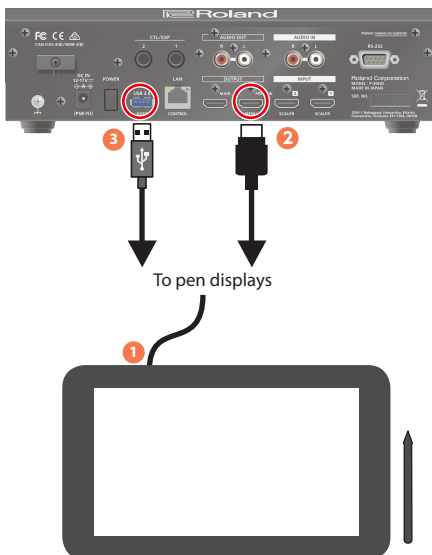

1. Follow the steps in your pen display's Owner's Manual to connect the cable to your pen display.
2. Connect the HDMI connector to the PREVIEW connector on the P-20HD.
3. Connect the USB connector to the USB 3.0 port on the P-20HD.

* If you want to use a USB storage device or a USB keyboard with the P-20HD at the same time, connect with a USB hub.

Connecting to a Pen Tablet

When using a pen tablet with this unit, you can draw using the pen tablet while looking at the video image on your display (connected to the PREVIEW connector), and composite the image with what you draw.

1. Use the USB cable included with your pen tablet to connect the pen tablet to the P-20HD.
2. Connect the PREVIEW connector on the P-20HD to a display that supports an HDMI connection.

Getting Ready to Use Annotation

Enabling annotation

1. From the [MENU] button → select “Annotation” → “Switch” and press the [VALUE] knob.
2. Select “On,” and press the [VALUE] knob.

While annotation is enabled, the output video from the P-20HD along with the buttons for controlling the animation are shown on the external display or pen display connected to the PREVIEW connector.

* The following screen is shown in this unit’s display if a pen tablet is not connected.

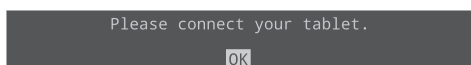

3. Press the [MENU] button to close the menu.

To disable annotation, set “Switch” to “Off.” When the confirmation message appears, select “OK” and press the [VALUE] knob.

Displaying the cursor

You can make the pen cursor display in the PREVIEW screen.

1. From the [MENU] button → select “Annotation” → “Cursor Display” and press the [VALUE] knob.
2. Set whether the cursor is shown or hidden, and press the [VALUE] knob.

Menu	Explanation
Off	The cursor is not shown in the annotation screen that is output to the PREVIEW connector.
On	The cursor is shown in the annotation screen that is output to the PREVIEW connector.
Auto	The cursor is shown or hides depending on the type of pen tablet that’s connected. Pen display: cursor is hidden Pen tablet: cursor is shown

3. Press the [MENU] button to close the menu.

Calibration

You can calibrate the drawing position if the position of the pen/ cursor is out of alignment with the actual image that is drawn.

NOTE

There is no need to calibrate if you’re using a tablet without an LCD screen.

1. From the [MENU] button → select “Annotation” → “Calibration” and press the [VALUE] knob.

A calibration screen is shown on the PREVIEW screen (pen display).

A confirmation message is shown on this unit’s display.

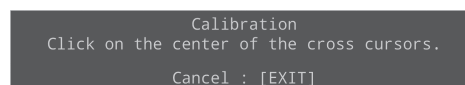

2. Click the cross-shaped cursor on the four corners of the screen in order with the pen.



Each cross-shaped cursor changes from white to red when clicked.

Once all the cross-shaped cursors in all four corners have turned red, the calibration is finished.

The display automatically returns to the menu after calibration.

* To cancel calibration, press the [EXIT] button on the P-20HD.

Drawing on the Screen

While annotation is enabled, the output video from the P-20HD along with the buttons for controlling the animation are shown on the external display or pen display connected to the PREVIEW connector. Use these annotation buttons to draw using the pen.

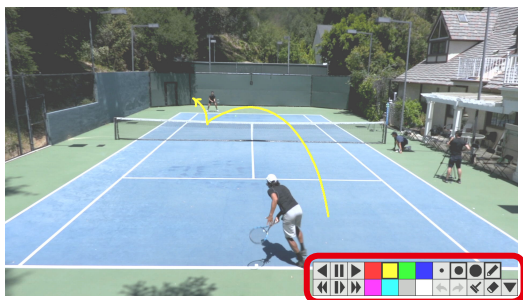

You can use the annotation buttons on the P-20HD for the following operations.

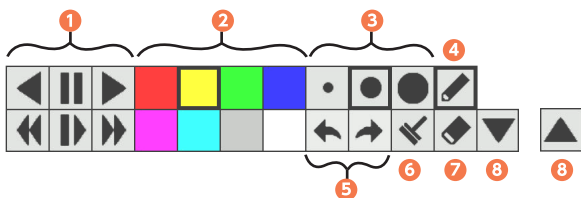

Button	Explanation	
Transport		
1		Plays in reverse.
		Stops playback.
		Plays back.
		Plays in reverse at double speed.
		Plays back in slow motion (x0.5).
		Plays back at double speed.
Color palette		
2	Selects the pen color. A cursor border is shown around the selected color.	
Thickness		
3	Selects the thickness for the pen and eraser. A cursor border is shown around the selected button. You can set the pen and eraser thickness individually.	
Draw		
4	Draws using the pen.	

Button	Explanation
Undo/ Redo	
5	Reverts to the previous operation (Undo). The operations that can be undone are drawing, erasing and clear. * This is enabled only when the undo operation is available.
	Reverts the undo operation (Redo). The operations that can be redone are drawing, erasing and clear. * This is enabled only when the redo operation is available.
Clear	
6	Erases the area drawn with the pen.
Eraser	
7	Clears all contents drawn on the screen.
Button display	
8	Hides (minimizes) the annotation buttons.
	Shows the annotation buttons.

NOTE

- The image you've drawn is deleted when the output resolution is changed.
- The image you've drawn is deleted when you unplug the pen tablet's USB cable from the P-20HD, or when you turn annotation off from the menu.
- Any drawings you make are not saved.

Other Functions

Saving this Unit's Settings to a SD Card/USB Storage

You can group together the unit's settings into a single file (with a ".p20" extension) and save this to an SD card or USB storage. The saved file can be loaded into this unit from the SD card or USB storage when necessary.

* Depending on the USB storage used, it may take a while for the unit to recognize the media.

Saving the file

When overwriting an existing file:

1. Press the [MENU] button → "SD Card/USB Memory" → select "Save Settings," and press the [VALUE] knob.

The Save Settings screen appears.



2. Select either "Save to SD Card" or "Save to USB Memory," and press the [VALUE] knob.

The backup file list appears.

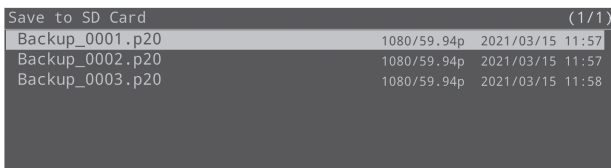

3. Select the file to overwrite, and press the [VALUE] knob.

A confirmation message appears.

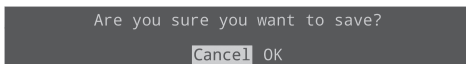

* If you decide to cancel, press the [EXIT] button.

4. Select "OK" and press the [VALUE] knob.

This saves the file to the SD card or USB storage, and the unit returns to the main screen.

When saving a new file or saving with a different filename:

1. Press the [MENU] button → "SD Card/USB Memory" → select "Save Settings As," and press the [VALUE] knob.

The Save Settings as screen appears.



2. Select either "Save to SD Card" or "Save to USB Memory," and press the [VALUE] knob.

The Save to SD Card or Save to USB Memory screen appears.

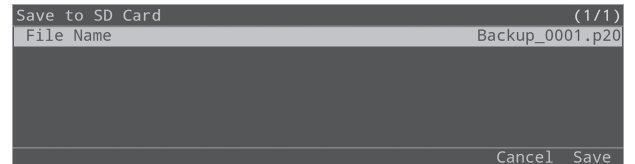

3. Select "File Name," and press the [VALUE] knob.

4. Enter the file name.

* You can input a maximum of 20 characters (excluding the extension).

1. Use the [VALUE] knob to move the cursor, and press the [VALUE] knob.

The cursor blinks.

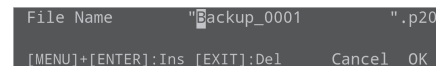

2. Use the [VALUE] knob to edit the character, and press the [VALUE] knob.

- Hold down the [MENU] button and press the [VALUE] knob to insert a character at the cursor position.
- Press the [EXIT] button to delete the character at the cursor position.

3. When you finish entering the name, use the [VALUE] knob to select "OK," and press the [VALUE] knob.

5. Select "Save," and press the [VALUE] knob.

A confirmation message appears.

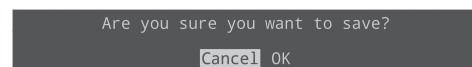

* If there is already a file with the same name, an overwrite confirmation message appears.

* If you decide to cancel, press the [EXIT] button.

6. Select "OK" and press the [VALUE] knob.

This saves the file to the SD card or USB storage, and the unit returns to the main screen.

Recalling the saved settings

This is how to load a file saved on a SD card or USB storage back into this unit. When you load the settings, the current settings in this unit are overwritten.

1. Press the [MENU] button → “SD Card/USB Memory” →select “Load Settings,” and press the [VALUE] knob.

The Load Settings screen appears.



2. Select either “Load from SD Card” or “Load from USB Memory,” and press the [VALUE] knob.

The backup file list appears.



3. Select the file that you want to recall, and press the [VALUE] knob.

A confirmation message appears.

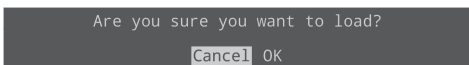

4. Select “OK” and press the [VALUE] knob.

The settings are now loaded, and the unit returns to the main screen.

Formatting an SD Card

When using an SD card for the first time, you must format it on the P-20HD.

NOTE

- The P-20HD does not recognize SD cards that were not formatted on this unit.
- Formatting the media erases all data saved on the SD card (such as this unit’s settings and video data). If the storage media contains important data, back the data up to your computer before you format it.

1. Press the [MENU] button → “SD Card/USB Memory” →select SD Card “Format,” and press the [VALUE] knob.

A confirmation message appears.

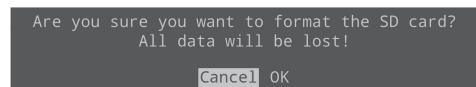

* If you decide to cancel, press the [EXIT] button.

2. Select “OK” and press the [VALUE] knob.

The SD card is now formatted.

When formatting is complete, the message “Completed.” appears.

3. Press the [VALUE] button to close the message.

4. Press the [MENU] button to close the menu.

Importing Title Materials

You can import still images such as event logos, corporate logos and so on, and layer them on top of live in video and replay video as title materials.

Supported files

Format	Bitmap file (.bmp), 24-bit color, uncompressed
	PNG file (.png), 24-bit color, 8-bit with alpha channel
File name	Must be single-byte alphanumeric characters, up to 32 characters long including the extension.
	The extension (".bmp" or ".png") must be added.
Size	480 x 270 (maximum 1920 x 1080) pixels
	* If the still image size is greater than 480 x 270 pixels, the image is cropped to 480 x 270 when imported.
No. of images	One each for live in and replay video

1. Save the still image in the root directory of the USB storage.
2. Connect the USB storage to the USB 3.0 port.
3. Press the [MENU] button → "Project" → select "Project Settings," and press the [VALUE] knob.
The Project Settings screen appears.
4. Select "Import LIVE IN Title" or "Import REPLAY Title," and press the [VALUE] knob.

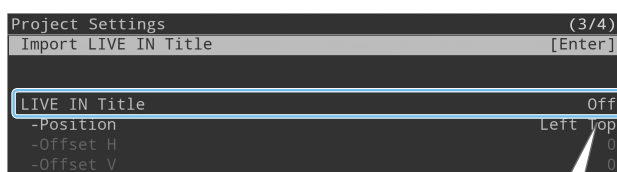

The import operation does not work when LIVE IN Title or REPLAY Title is set to "Imported." Make the settings as necessary.

This displays the still image list.

- * If there is already a still image, an overwrite confirmation message appears.

5. Select a still image to import, and then press the [VALUE] knob.



A confirmation message appears.

- * If you decide to cancel, press the [EXIT] button.

6. Select "OK" and press the [VALUE] knob.

The still image is imported.



The filename of the still image is shown.

7. Press the [MENU] button to close the menu.

Displaying the Title

1. Press the [MENU] button → "Project" → "Project Settings" → select "LIVE IN Title" or "REPLAY Title," and press the [VALUE] knob.

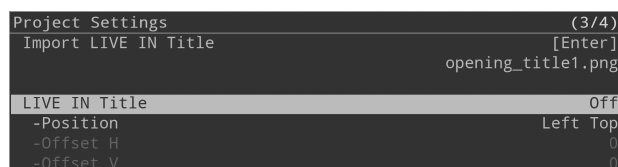

2. Select "Imported," and press the [VALUE] knob.

The title is shown on the live in or replay video.

3. Select a menu item shown below, and press the [VALUE] knob.

Menu item	Explanation
LIVE IN Title	Use the following parameters to adjust the title position for the live in video.
Position	Sets the position (upper left, upper right, lower left, lower right) of the title.
Offset H	Adjusts the horizontal position of the title.
Offset V	Adjusts the vertical position of the title.
REPLAY Title	Use the following parameters to adjust the title position for the replay video.
Position	Sets the position (upper left, upper right, lower left, lower right) of the title.
Offset H	Adjusts the horizontal position of the title.
Offset V	Adjusts the vertical position of the title.

4. Adjust the title position and press the [VALUE] knob.

5. Press the [MENU] button to close the menu.

MEMO

If you select "LIVE" or "REPLAY" in step 2, you can display the preinstalled still images (text-based images that say either "LIVE" or "REPLAY").

Exporting Recorded Video Data

You can convert recorded video data or clips to MP4 (.mp4) files, and export this data to an SD card or to USB storage.

- * The files exported from the P-20HD can be downloaded to your computer via a network (FTP).
For the detailed operations, see “Exchanging Files with Your Computer via the Network (FTP)” (p. 49).

NOTE

Do not remove the SD card or USB storage device or turn off the power while data is being exported.

Exporting Recorded Video Data

Here’s how to convert recorded video data in a project to MP4 (.mp4), and export this data to an SD card or to USB storage as a single video file.

MEMO

When exporting video files, the time range information for clips added to the clip list is simultaneously exported as an **EDL file** (.edl) and an **FCPXML file** (.fcpxml).

By importing the exported movie file and EDL file into your video editing software that supports EDL files, you can recreate the state of the clip list in your video editing software.

- * FCPXML is the file format that contains editing information for Final Cut Pro.

1. Press the [MENU] button → “Project” → select “Project Utility,” and press the [VALUE] knob.

The project list appears.

2. Select the project that contains the recorded video data you want to export, and press the [VALUE] knob.

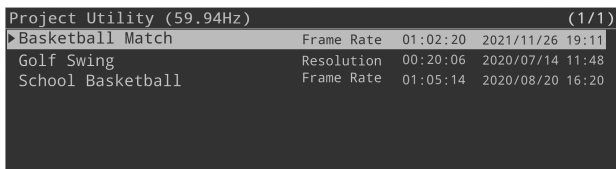

3. Select “Export Rec Data (mp4)” and press the [VALUE] knob.

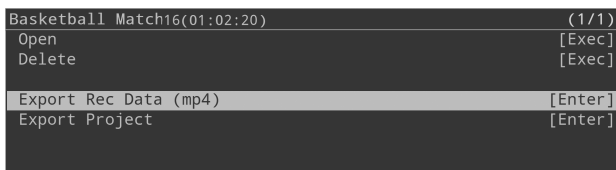

4. Select either “Export to SD Card” or “Export to USB Memory” depending on the media to which you want to export the data, and press the [VALUE] knob.

A confirmation message appears.

5. Select “OK,” and press the [VALUE] knob.

The recorded video data export begins.
When export is finished, the message “Completed.” appears.

6. Press the [MENU] button to close the menu.

MEMO

Each of the exported files is saved in the “/P-20HD_Export” folder.

Exporting Clips

Here’s how to convert the clip list or clips in the palette to MP4 (.mp4), and export this data to an SD card or to USB storage as a video file.

NOTE

The playback time for exported video files is slightly longer than the actual clips.

1. Select the clip to export in the CLIP LIST (PALETTE) screen, and press the [VALUE] knob.

The CLIP MENU screen appears.

2. Select “Export (mp4)” and press the [VALUE] knob.



3. Select either “Export to SD Card” or “Export to USB Memory” depending on the media to which you want to export the data, and press the [VALUE] knob.

A confirmation message appears.

4. Select “OK,” and press the [VALUE] knob.

The clip begins exporting.
When export is finished, the message “Completed.” appears.

5. Press the [MENU] button to close the menu.

MEMO

Exported video files are saved in the “/P-20HD_Export” folder.

Video file formats

The video files that are exported use the following format, according to the project’s Priority parameter and frame rate settings.

Priority	Frame Rate	Video file format
Resolution	59.94Hz	1080/29.97p
	50Hz	1080/25p
Frame Rate	59.94Hz	720/59.94p
	50Hz	720/50p

Exporting/Importing a Project

You can archive a project (the file extension used is “.pav”), and export the archive to an SD card or USB storage. Archived projects can be imported into this unit, restoring the original data.

* You can exchange projects that were exported from the P-20HD, between the P-20HD and your computer over a network (FTP). For the detailed operations, see “Exchanging Files with Your Computer via the Network (FTP)” (p. 49).

NOTE

Do not remove the SD card or USB storage device or turn off the power while data is being exported or imported.

Exporting a Project

1. Press the [MENU] button → “Project” → select “Project Utility,” and press the [VALUE] knob.

The project list appears.

2. Select a project to export, and then press the [VALUE] knob.

Project Utility (59.94Hz) (1/1)			
Basketball Match	Frame Rate	01:02:20	2021/11/26 19:11
Golf Swing	Resolution	00:20:06	2020/07/14 11:48
School Basketball	Frame Rate	01:05:14	2020/08/20 16:20

3. Select “Export Project,” and press the [VALUE] knob.

Basketball Match16(01:02:20) (1/1)	
Open	[Exec]
Delete	[Exec]
Export Rec Data (mp4)	[Enter]
Export Project	[Enter]

4. Select either “Export to SD Card” or “Export to USB Memory” depending on the media to which you want to export the data, and press the [VALUE] knob.

A confirmation message appears.

5. Select “OK,” and press the [VALUE] knob.

The project begins exporting.

When export is finished, the message “Completed.” appears.

6. Press the [MENU] button to close the menu.

MEMO

The exported project archive is saved in the “/P-20HD_Export” folder.

Importing a Project

You can import an archived project (with a file extension of “.pav”) saved to an SD card or USB storage into this unit.

The current project switches once the archived project is imported.

1. Press the [MENU] button → “Project” → select “Import Project,” and press the [VALUE] knob.

Project (1/1)	
New	[Enter]
Open	[Enter]
Project Settings	[Enter]
Project Utility	[Enter]
Import Project	[Enter]

2. Select either “Import from SD Card” or “Import from USB Memory” depending on the media from which you want to import the data, and press the [VALUE] knob.

Import Project (1/1)	
Import from SD Card	[Enter]
Import from USB Memory	[Enter]

The project archive list appears.

3. Select the project archive that you want to import, and press the [VALUE] knob.

A confirmation message appears.

4. Select “OK,” and press the [VALUE] knob.

The project begins importing.

When the import is finished, the project switches and the message “Completed.” appears.

Turning Off the Power from the Menu

In addition to using the [POWER] switch on the P-20HD to shut down the power, you can also power down this unit from the menu.

This method is useful when you want to turn the power on/off from the primary side of the AC adaptor. Leave the [POWER] switch pressed in, and instead turn off the power from the menu.

1. Press the [MENU] button → “System” → select “Shutdown,” and press the [VALUE] knob.

A confirmation message appears.

System	(3/3)
Test Pattern	Off
Test Tone	Off
Auto Off	Off
Shutdown	[Exec]
Factory Reset	[Exec]
Version	



Shutdown?
Cancel OK

* If you decide to cancel, press the [EXIT] button.

2. Select “OK,” and press the [VALUE] knob.

The unit turns off.

MEMO

To turn on this unit normally using the [POWER] switch, press the [POWER] switch once, and then press it again once the switch is in the off position.

Using a Footswitch

You can use a footswitch connected to the CTL/EXP 1 and 2 jacks to control the P-20HD with your foot. You can assign various functions to the footswitch.

MEMO

- See “Connecting a Footswitch” (p. 4) for how to connect a footswitch to this unit.
- If a single-pedal type footswitch such as the BOSS FS-5U is connected using a phone cable (mono), the function assigned by “CTL B” is enabled.

1. Press the [MENU] button → “Ctl/Exp” → “Ctl/Exp 1” or “Ctl/Exp 2” → select “Ctl/Exp Type,” and press the [VALUE] knob.

Ctl/Exp 1	(1/1)
Ctl/Exp Type	Off
Ctl A Assign	Mark IN
Ctl B Assign	Mark OUT
Exp Assign	Speed Control
Exp Calibration	[Enter]

2. Select “Ctl A & Ctl B” (the footswitch), and press the [VALUE] knob.

3. Select “Ctl A Assign” or “Ctl B Assign,” and press the [VALUE] knob.

Ctl/Exp 1	(1/1)
Ctl/Exp Type	Ctl A & Ctl B
Ctl A Assign	Mark IN
Ctl B Assign	Mark OUT
Exp Assign	Speed Control
Exp Calibration	[Enter]

4. Select the function that you want to assign to CTL A or CTL B of the footswitch, and press the [VALUE] knob.

* For details on the menu items, refer to “13: Ctl/Exp” (p. 62).

5. Press the [MENU] button to close the menu.

Using an Expression Pedal

You can use an expression pedal connected to the CTL/EXP 1 and 2 jacks to control the P-20HD with your foot.

Adjusting the Pedal (Pedal Calibration)

The first time you use an expression pedal, you must calibrate (adjust) the pedal so that it will operate optimally.

In some cases, an expression pedal might no longer operate optimally due to the passage of time or changes in the operating conditions. If you notice problems such as slight movements of the pedal causing a major change in volume, or if the video fails to switch when you press the pedal, you should execute calibration

1. Press the [MENU] button → “Ctl/Exp” → “Ctl/Exp 1” or “Ctl/Exp 2” → select “Ctl/Exp Type,” and press the [VALUE] knob.



2. Select “Exp” (the expression pedal), and press the [VALUE] knob.

3. Select “Exp Calibration,” and press the [VALUE] knob.



4. Following the onscreen instructions, push down on the pedal with your heel, and press the [VALUE] knob.

The minimum value (min) can be set to a position below the center line of the meter.

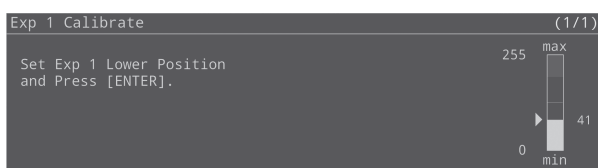

5. Following the onscreen instructions, push up on the pedal with your toes, and press the [VALUE] knob.

The maximum value (max) can be set to a position above the center line of the meter.

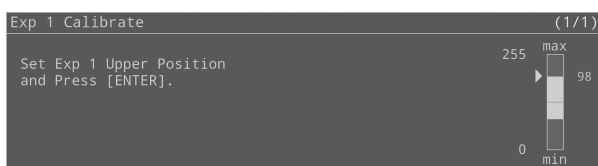

When the message “Completed.” appears, calibration is complete.

6. Press the [MENU] button to close the menu.

Assigning a Function to the Pedal

You can assign various functions to the expression pedal.

1. Press the [MENU] button → “Ctl/Exp” → “Ctl/Exp 1” or “Ctl/Exp 2” → select “Ctl/Exp Type,” and press the [VALUE] knob.



2. Select “Exp” (the expression pedal), and press the [VALUE] knob.

3. Select “Exp Assign,” and press the [VALUE] knob.

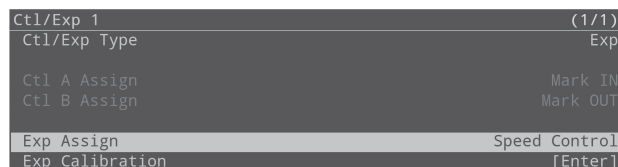

4. Select the function that you want to assign to the expression pedal, and press the [VALUE] knob.

* For details on the menu items, refer to “13: Ctl/Exp” (p. 62).

5. Press the [MENU] button to close the menu.

Preventing Unintended Operation (Panel Lock)

You can disable operation of the panel's buttons and knobs to prevent unintended operations (Panel Lock function).

1. Press the [MENU] button → “System” → select “Panel Lock,” and press the [VALUE] knob.

The Panel Lock menu appears.

Panel Lock		Lock: [ENTER]+[MENU] (1/5)
All		Off
REC Button		Off
AUDIO OUT Knob		Off
INPUT/OUTPUT Section		
-INPUT SELECT Button		Off
-OUTPUT SELECT Buttons		Off

2. Select a target for panel lock, and press the [VALUE] knob.

* For details on the menu items, refer to “Panel Lock” (p. 64) in the System menu.

3. Select “On,” and press the [VALUE] knob.
4. Press the [MENU] button to close the menu.
5. Hold down the [VALUE] knob and long-press the [MENU] button (for at least three seconds).

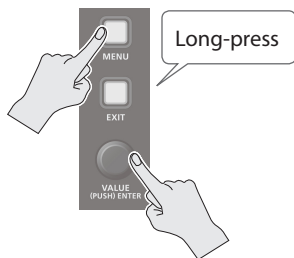

The message “Panel Locked.” is shown, and the panel lock is activated.

This locks the buttons and knobs that you set to “On” in step 3.

6. To turn the panel lock off, hold down the [VALUE] knob again and long-press the [MENU] button (for at least three seconds).

The message “Lock Released.” appears, and the panel lock is deactivated.

Returning to the Factory Settings (Factory Reset)

Here's how you can return the settings of the P-20HD to their factory-set state.

If the unit does not operate as described even though you've followed the steps in the manual, try executing a factory reset.

NOTE

- When you execute a factory reset, all of the settings you made are lost (excluding the project settings and data).
- Be sure not to turn off the power after the factory reset until the unit returns to the main screen.

1. Press the [MENU] button → “System” → select “Factory Reset,” and press the [VALUE] knob.

A confirmation message appears.

System		(3/3)
Test Pattern		Off
Test Tone		Off
Auto Off		On
Shutdown		[Exec]
Factory Reset		[Exec]
Version		1.20.011

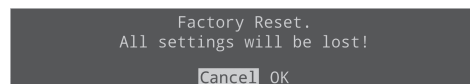

* If you decide to cancel, press the [EXIT] button.

2. Select “OK,” and press the [VALUE] knob.

The factory reset is executed.

Once the factory reset is complete, you are returned to the main screen.

Using a USB Keyboard to Operate the P-20HD

You can connect a USB keyboard (commercially available) to the USB 3.0 port to operate the P-20HD.

* This unit supports the use of 101/102-key keyboards.

* If you want to use both USB storage and a pen tablet with the P-20HD at the same time, use a USB hub to connect.

P-20HD operating panel		Key operations	
Common	[VALUE] knob	Turn counterclockwise	[→]
		Press while turning counterclockwise	[Ctrl] + [→]
		Turn clockwise	[←]
		Press while turning clockwise	[Ctrl] + [←]
		Press	[Enter]
	[EXIT] button	[Back Space]	
INPUT	[REC] button	[r]	
	[EXIT] + [REC] button	[Back Space] + [r]	
	[SELECT] button	[F5]	
	[EXIT] + [SELECT] button	[Back Space] + [F5]	
AUDIO OUT	[AUDIO OUT] knob	Turn counterclockwise	[F9] [Ctrl] + [F9] (the value changes in larger increments)
		Turn clockwise	[F10] [Ctrl] + [F10] (the value changes in larger increments)
Pad	[STILL] button	[s]	
	[AUDIO] button	[a]	
	[CLIP LIST] button	[c]	
	[PALETTE] button	[p]	
	[PALETTE] button + pads [1]–[8]	[p] + [1]–[8]	
	Pads [1]–[8]	[1]–[8]	
	[<] button	[Page Down]	
	Move to the first page	[Ctrl] + [Page Down]	
	[>] button	[Page Up]	
	Move to the last page	[Ctrl] + [Page Up]	
SPEED	[SPEED] lever	Raise	[↑] [Ctrl] + [↑] (the value changes in larger increments)
		Lower	[↓] [Ctrl] + [↓] (the value changes in larger increments)
	[SPEED RANGE] button	[F6]	
MARKER	[LIVE IN] button	[F7]	
	[DELETE] button	[Delete]	
	[IN] button	[i]	
	[OUT] button	[o]	
	[BOOKMARK] button	[b]	
AUTO PLAY	[MAKE CLIP] button	[m]	
	[CLIP] button	[d]	
OUTPUT	[PALYLIST] button	[f]	
	[LIVE IN] button	[,] (comma)	
	[REPLAY] button	[.] (period)	
TRANSPORT	[◀] button/[▶] button	[v] / [n]	
	Jump to the first bookmark	[Ctrl] + [v]	
	Jump to the last bookmark	[Ctrl] + [n]	
	[⏸] button	[Esc] or [Pause]	
	[▶] button	[Space]	
MENU	[MENU] button	[F1]	
JOG/SHUTTLE	[JOG] button	[j]	
	[SHUTTLE] button	[h]	
	[JOG/SHUTTLE] dial	Turn counterclockwise	[-] [Ctrl] + [-] (The value changes in larger increments. Enabled when in JOG mode.)
		Turn clockwise	[+] [Ctrl] + [+] (The value changes in larger increments. Enabled when in JOG mode.)
Shortcut	Add current clip to the specified palette	[Alt] + [1]–[8]	
	Deleting the current clip	[Alt] + [Delete]	

Using LAN

By connecting the LAN CONTROL jack to your network device such as a computer, you can use the following features.

- Transmit commands from your network device to remotely control the P-20HD.
- Download/upload archived projects between your computer and the P-20HD via FTP.
- Download exported videos, EDL and FCPXML files from the P-20HD to your computer via FTP.

* This product cannot be used to directly connect to a network operated by a telecommunications provider (such as a mobile or landline-based telecommunications company, an Internet provider or the likes), including a public wireless LAN. You must use a router or similar equipment when connecting this product to the Internet.

LAN Interface

This uses the LAN CONTROL port on the P-20HD.

Communication standards

Port	LAN CONTROL port
TCP port number	Remote control connection: 8023 FTP: 21

* Use a CAT5e LAN cable or better when connecting your network device to the P-20HD.

Configuring the Network Settings

1. Press the [MENU] button → “LAN” → select the menu item shown below, and press the [VALUE] knob.



Menu item	Explanation
IP Setting	Selects how settings are made for the IP address, subnet mask, and default gateway. Using DHCP: The IP address and other information needed for connecting to the network is obtained automatically from the DHCP server of the LAN. Manually: The IP address, subnet mask, and default gateway are specified manually.
IP Address	Shows the IP address. (*1)
Subnet Mask	Shows the subnet mask. (*1)
Gateway	Shows the default gateway. (*1)

(*1) When IP Setting is set to “Manually,” set these respectively according to the network.

2. Change the value of the setting, and press the [VALUE] knob.

Once the LAN connection is established, “Connected” is shown in the title bar.

3. Select User Account “User ID,” and press the [VALUE] knob.

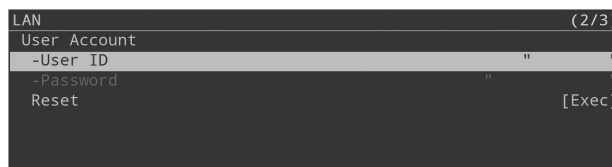

4. Input your user ID (4–8 characters).

The user ID that you set here is required later, when you make a remote control connection or an FTP connection from your network device to the P-20HD.



5. Select “OK” and press the [VALUE] knob.

6. Select User Account “Password” and press the [VALUE] knob.

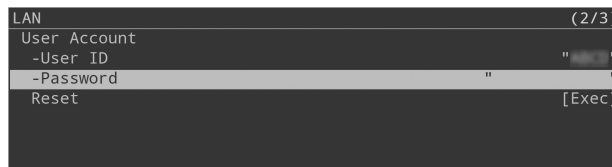

7. Input your password (8–12 characters).

The password that you set here is required later, when you make a remote control connection or an FTP connection from your network device to the P-20HD.



8. Select “OK” and press the [VALUE] knob.

9. Press the [MENU] button to close the menu.

MEMO

You can reset your user ID and password by executing User Account “Reset.”

Remotely Controlling the P-20HD via Network Device

You can remotely control the P-20HD by transmitting commands to the P-20HD from the Telnet client of a network device.

* For details on the commands used, refer to "Remote Control Commands (LAN/RS-232)" (p. 69).

Getting ready

1. Connect your network device to the P-20HD via the network.

* For details on the settings to use on the P-20HD, refer to "Configuring the Network Settings" (p. 48).

Settings on the P-20HD

2. Press the [MENU] button → "LAN" → select "Remote Control," and press the [VALUE] knob.

3. Select "On," and press the [VALUE] knob.

This lets you transmit/receive commands to/from your network device.

4. Press the [MENU] button to close the menu.

Settings on the Telnet client

5. Start the Telnet client and input the host name and TCP port.

This connects the network device to the P-20HD.

Host name	IP address of P-20HD
TCP port number	8023

6. Transmit the user ID command for the P-20HD.

7. Transmit the password command for the P-20HD.

8. Transmit the version request command.

The connection is established after confirming the response command to the P-20HD version information. Now you can remotely control the P-20HD by transmitting commands to the P-20HD from the Telnet client.

Exchanging Files with Your Computer via the Network (FTP)

You can use an FTP client to connect your computer to the P-20HD and perform the following file operations. When using an FTP connection, the contents of the "/P-20HD_Export" folder on your SD card or USB storage are shared.

- Downloading/uploading an exported (p. 43) project archive
- Downloading an exported (p. 42) video, EDL or FCPXML file

Getting ready

1. Install an FTP client on your computer.

2. Connect your computer to the P-20HD via the network.

* For details on the settings to use on the P-20HD, refer to "Configuring the Network Settings" (p. 48).

Settings on the P-20HD

3. Press the [MENU] button → "LAN" → select FTP "Directory," and press the [VALUE] knob.

4. Select the media you wish to access from your computer (SD Card or USB Memory), and press the [VALUE] knob.

5. Select "FTP," and press the [VALUE] knob.

6. Select "On," and press the [VALUE] knob.

Once you've done this, you can access the "/P-20HD_Export" folder on USB storage or SD card from your computer.

Once the FTP connection is established, "Online" is shown in the "Status" parameter.

7. Press the [MENU] button to close the menu.

Settings on the FTP client

8. Launch the FTP client.

9. In the connection dialog box, input the host name, user name and password, and click "Connect."

Host name	IP address of P-20HD
User name	User ID for the P-20HD
Password	Password for the P-20HD

* The labels shown in the connection dialog box may differ with each app.

* Disable the anonymous authentication setting, if one exists.

The connection has been established once the P-20HD's files are shown.

Using RS-232

By connecting the RS-232 connector to a controlling device such as a computer or to a Roland video switcher, you can use the following features.

- Transmit commands from your controlling device to remotely control the P-20HD.
- Synchronize P-20HD playback and the video transition on your video switcher.

RS-232 Interface

RS-232 connector pin layout

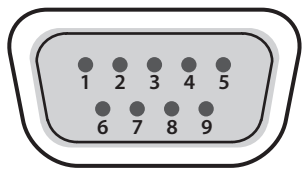

DB-9 type (male)

Pin assignments

Pin No.	Signal
1	N.C.
2	RXD
3	TXD
4	DTR
5	GND
6	DSR
7	RTS
8	CTS
9	N.C.

Communication standards

Communication method	Synchronous (asynchronous), full-duplex
Communication speed	9,600, 38,400 bps
Parity	none
Data length	8 bits
Stop bit	1 bit
Code set	ASCII

Cable wiring diagram

Use an RS-232 crossover cable to connect the P-20HD and the controller (an RS-232-compatible computer or other device).

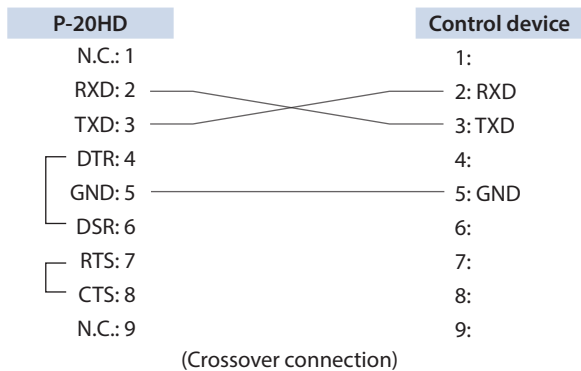

* The connections between 4 and 6 and between 7 and 8 are inside the P-20HD.

Remotely Controlling the P-20HD from a Controlling Device

You can remotely control the P-20HD from a controlling device such as a computer by transmitting commands.

* For details on the commands used, refer to "Remote Control Commands (LAN/RS-232)" (p. 69).

Getting ready

1. Connect the P-20HD with the controlling device using an RS-232 crossover cable.

Settings on the P-20HD

2. Press the [MENU] button → "RS-232" → select "Remote Control," and press the [VALUE] knob.



3. Select "PC," and press the [VALUE] knob.

This lets you transmit/receive commands to/from the controlling device.

4. Press the [MENU] button to close the menu.

Synchronizing the P-20HD with the Roland Video Switcher

You can operate this unit by synchronizing the P-20HD playback and the video transition on your video switcher.

* The P-20HD video must be inputted to the video switcher.

The P-20HD can operate either as a host or as a remote.

- As a host

When playing back a clip or playlist on the P-20HD, the final output on the video switcher automatically switches to the P-20HD video.

When playback finishes, the video returns to the channel that was selected before the video switched.

- As a remote

The clip selected on the P-20HD automatically plays back when you operate the video switcher and perform the final output of the P-20HD video.

To check which video switchers are compatible, access the website shown below.

<https://roland.cm/p-20hd>

Using the P-20HD as host

This explains how to configure the settings, using the example of connecting to the V-60HD.

Getting ready

1. Connect the P-20HD to the V-60HD using an RS-232 crossover cable.
2. Connect the OUTPUT MAIN connector of the P-20HD to the HDMI IN 5 or HDMI IN 6 connector of the V-60HD.

Settings on the V-60HD

3. Make the RS-232/GPI menu settings as follows.

Menu item	Setting
RS-232	ON
BAUDRATE	Use the same settings as the P-20HD.
PANEL INFORMATION	ON

Settings on the P-20HD

4. Press the [MENU] button → select "RS-232," and press the [VALUE] knob.

The RS-232 menu appears.

RS-232	(1/1)
Baudrate	9600bps
Remote Control	Switcher
-Target Model	V-60HD
-Input Channel	Ch6
-Host/Remote	Host
-Time Offset at Play Start	0ms
-Time Offset at Play End	0ms

5. Use the [VALUE] knob to change the setting as shown below.

Menu item	Setting
Baudrate	Use the same settings as the V-60HD.
Remote Control	Switcher
Target Model	V-60HD
Input Channel	Ch5 or Ch6 (select the V-60HD channel used for inputting the P-20HD video).
Host/Remote	Host
Time Offset at Play Start	Begin playing back the clip or playlist on the P-20HD, and then adjust the time it takes before the video transition starts on the V-60HD.
Time Offset at Play End	Adjust the time it takes before the video transition starts, so that the V-60HD video transition finishes when the clip or playlist stops playing back on the P-20HD.

6. Press the [MENU] button to close the menu.

Using the P-20HD as remote

This explains how to configure the settings, using the example of connecting to the V-60HD.

Getting ready

1. Connect the P-20HD to the V-60HD using an RS-232 crossover cable.
2. Connect the OUTPUT MAIN connector of the P-20HD to the HDMI IN 5 or HDMI IN 6 connector of the V-60HD.

Settings on the V-60HD

3. Make the RS-232/GPI menu settings as follows.

Menu item	Setting
RS-232	ON
BAUDRATE	Use the same settings as the P-20HD.
PANEL INFORMATION	ON

Settings on the P-20HD

4. Press the [MENU] button → select "RS-232," and press the [VALUE] knob.

The RS-232 menu appears.

5. Use the [VALUE] knob to change the setting as shown below.

Menu item	Setting
Baudrate	Use the same settings as the V-60HD
Remote Control	Switcher
Target Model	V-60HD
Input Channel	Ch5 or Ch6 (Select the V-60HD channel used for inputting the P-20HD video.)
Host/Remote	Remote

6. Press the [MENU] button to close the menu.

Menu List

When you press the [MENU] button, the menu is shown on this unit's display and on the display connected to the OUTPUT PREVIEW connector.

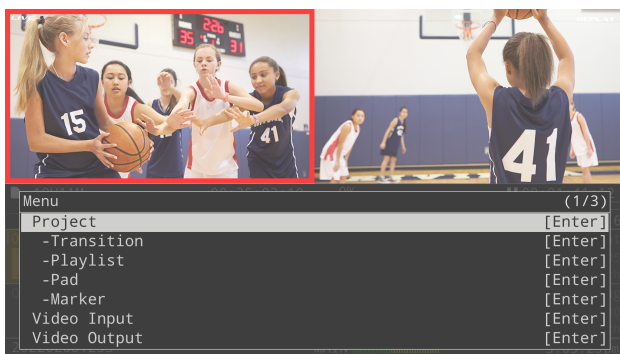

MEMO

- If “[Enter]” is shown for the setting value, you can press the [VALUE] knob to proceed to a lower-level menu.
- Press the [VALUE] knob to execute an operation.
- By turning the [VALUE] knob while pressing it, you can change the value more greatly.
- Long-pressing the [VALUE] knob returns the currently selected menu item to its default value.

1: Project

Menu item	Value (Bold: default)	Explanation
New	[ENTER]	Creates a new project.
Open	[ENTER]	Shows the list for selecting a project.
Project Settings	[ENTER]	Switches to the project settings menu.
Project Utility	[ENTER]	Switches to the project utility menu.
Import Project	[Enter]	Imports a project archive stored on a SD card or USB storage into this unit.

New Project

Menu item	Value (Bold: default)	Explanation
Project Name	YYYYMMDDHHMM	Input the project name here. (The default value is the date and time.)
Mode	–	–
Priority	Selects the recording/playback mode.	
	Resolution	A recording and playback mode in which resolution is given priority. This is effective for high-definition video.
	Frame Rate	A recording and playback mode in which frame rate is given priority. This is effective for video with rapid motion, such as sporting events.

Project Settings

Menu item	Value (Bold: default)	Explanation
Project Name	YYYYMMDDHHMM	Input the project name here. (The default value is the date and time.)
Mode	–	–
Priority	Resolution, Frame Rate	Shows the recording and playback mode.
Default Clip Length	1.0– 7.0 –60.0sec	Sets the length of clips created using the MAKE CLIP function.
Auto Marker	Off , 1–60min	Automatically adds markers while you are recording, at the intervals you specify.
Playback Audio Source	REPLAY	Uses the REPLAY sound for the audio during replay.
	LIVE IN	Uses the LIVE IN sound for the audio during replay.
JOG Speed	When in jog mode, this sets the frame advance interval when you turn the [JOG/SHUTTLE] dial.	
	Normal	1-frame interval
	High	18-frame interval * When recording/playback mode (Priority) is “Frame Rate” 9-frame interval * When recording/playback mode (Priority) is “Resolution”
[JOG] + Dial	When in jog mode, this sets the frame advance interval when you turn the [JOG/SHUTTLE] dial while holding down the [JOG] button.	
	Normal	1-frame interval
	High	18-frame interval * When recording/playback mode (Priority) is “Frame Rate” 9-frame interval * When recording/playback mode (Priority) is “Resolution”

Menu item	Value (Bold: default)	Explanation
SHUTTLE Speed	x1, x2, x4, x8, x16, x32, x64 , x128	When in shuttle mode, this sets the speed factor (maximum value) when you turn the [JOG/SHUTTLE] dial.
[SHUTTLE] + Dial	x1, x2, x4, x8, x16, x32, x64, x128	When in shuttle mode, this sets the speed factor (maximum value) when you turn the [JOG/SHUTTLE] dial while holding down the [SHUTTLE] button.
Import LIVE Title	[ENTER]	Imports the title material (still image) from USB storage for the live in video.
	(File name)	Displays the filename of the imported title material.
LIVE IN Title	This sets the title shown on the live in video.	
	Off	The title is not shown.
	LIVE	Displays the preinstalled still image (a text-based image that says "LIVE").
	Imported	Displays the imported title material.
Position	Left Top , Right Top, Left Bottom, Right Bottom	Sets the title position.
Offset H (*1)	0–200	Adjusts the horizontal position of the title.
Offset V (*1)	0–200	Adjusts the vertical position of the title.
Import REPLAY Title	[ENTER]	Imports the title material (still image) from USB storage for the replay video.
	(File name)	Displays the filename of the imported title material.
REPLAY Title	Selects the title shown on the replay video.	
	Off	The title is not shown.
	REPLAY	Displays the preinstalled still image (a text-based image that says "REPLAY").
	Imported	Displays the imported title material.
Position	Left Top, Right Top , Left Bottom, Right Bottom	Sets the title position.
Offset H (*2)	0–200	Adjusts the horizontal position of the title.
Offset V (*2)	0–200	Adjusts the vertical position of the title.

(*1) This can be set if LIVE IN Title is "Imported."

(*2) This can be set if REPLAY Title is "Imported."

Project Utility

Menu item	Value (Bold: default)	Explanation
Open	[Exec]	Opens the project.
Delete	[Exec]	Deletes the project.
Export Rec Data (mp4)	[Enter]	Here's how to convert video files in a project to MP4 (.mp4), and export this data to an SD card or to USB storage. * The time range information for clips added to the clip list is simultaneously exported as an EDL file (.edl) and an FCPXML file (.fcpxml). * Each exported file is saved to the "/P-20HD_Export" folder on your SD card or USB storage are shared.
Export Project	[Enter]	Archives a project and exports it to an SD card or to USB storage.

2: Transition

LIVE IN ► REPLAY, REPLAY ► LIVE IN

Menu item	Value (Bold: default)	Explanation					
Time	0.0– 1.0 –5.0sec	Sets the transition effect time.					
Type	Mix , Wipe	Sets the transition effect type.					
Wipe Pattern	Selects the wipe pattern.						
	Horizontal	Vertical	Upper Left	Upper Right	Lower Left	Lower Right	H-Center
Wipe Direction	Normal , Reverse	Selects the wipe direction.					

3: Playlist

Menu item	Value (Bold: default)	Explanation
CLIP LIST	[ENTER]	Configures the settings for the clip list.
PALETTE 1	[ENTER]	Configures palette 1.
PALETTE 2	[ENTER]	Configures palette 2.
PALETTE 3	[ENTER]	Configures palette 3.
PALETTE 4	[ENTER]	Configures palette 4.
PALETTE 5	[ENTER]	Configures palette 5.
PALETTE 6	[ENTER]	Configures palette 6.
PALETTE 7	[ENTER]	Configures palette 7.
PALETTE 8	[ENTER]	Configures palette 8.

Menu item	Value (Bold: default)	Explanation
Duration	–	Shows the length of the clips chained together in the palette.
Transition	–	–
Time	0.0– 1.0 –5.0sec	Sets the transition effect time between clips.
Type	Black Fade , White Fade	Selects the type of transition effect used between clips.

4: Pad

Menu item	Value (Bold: default)	Explanation
STILL	[ENTER]	Configures the settings for all still image clips.
AUDIO	[ENTER]	Configures the settings for all audio clips.
CLIP LIST	[ENTER]	Configures the settings for the clip list.
PALETTE (*current palette number)	[ENTER]	Configures the settings for the current palette.

STILL

Menu item	Value (Bold: default)	Explanation
Clear All	[Exec]	Deletes all of the still image clips.

AUDIO

Menu item	Value (Bold: default)	Explanation
Clear All	[Exec]	Deletes all of the audio clips.

CLIP LIST

Menu item	Value (Bold: default)	Explanation
Create Thumbnails	[Exec]	Creates thumbnails for clips that do not yet have a thumbnail.
Clear All	[Exec]	Deletes all of the clips in the clip list.

PALETTE

Menu item	Value (Bold: default)	Explanation
Create Thumbnails	[Exec]	Creates thumbnails for clips that do not yet have a thumbnail.
Clear All	[Exec]	Deletes all of the clips in the current palette.
Pad Color	Yellow, Green, Magenta (even-numbered palettes), Red, Blue (odd-numbered palettes), Orange	Specifies the color of the pad illumination.

5: Marker

Menu item	Value (Bold: default)	Explanation
01-	[ENTER]	Moves to a specified marker.

6: Video Input

Menu item	Value (Bold: default)	Explanation
LIVE IN 1	[ENTER]	Configures LIVE IN 1.
LIVE IN 2	[ENTER]	Configures LIVE IN 2.
PinP	[ENTER]	Configures PinP.
SPLIT	[ENTER]	Configures the split.

LIVE IN 1, LIVE IN 2

Menu item	Value (Bold: default)	Explanation
Status	-	Displays information about the input video (video format, size, etc.).
Input Source	HDMI , Black, White, Gray, Green, Blue	Selects the input source.
Flicker Filter	Off , On	If this is set to "On," flickering is reduced.
EDID	Internal , SVGA (800 x 600), XGA (1024 x 768), WXGA (1280 x 800), FWXGA (1366 x 768), SXGA (1280 x 1024), SXGA+ (1400 x 1050), UXGA (1600 x 1200), Full HD (1920 x 1080), WUXGA (1920 x 1200), 720/59.94p, 1080/59.94i, 1080/59.94p	Specifies the input format (EDID). If this is set to "Internal," EDID data for all formats that can be input to the P-20HD is transmitted. What is EDID? EDID is data that is transmitted from the P-20HD to the source device when the P-20HD is connected to a source device. EDID contains data such as the formats that can be input to the P-20HD (resolution, color space, color depth) and audio information. Based on the EDID data that the source device receives, it outputs the most appropriate video format to the P-20HD.
Zoom	10.0- 100.0 -1000.0% (*2)	Adjusts the zoom ratio.
Scaling Type	Specifies the scaling type.	
	Full	Always displays the picture expanded to full screen, irrespective of the aspect ratio of the input video.
	Letterbox	Enlarges or reduces the incoming video to a full-screen view while keeping the aspect ratio unchanged.
	Crop	Enlarges or reduces the incoming video so that the output picture has no blank margins while keeping the aspect ratio unchanged. Video extending beyond the borders is cut off.
	Dot by Dot	Performs no scaling.
Manual Size H	-2000- 0 - +2000 (*3)	Adjusts the horizontal size.
Manual Size V	-2000- 0 - +2000 (*3)	Adjusts the vertical size.
Position H	-1920- 0 - +1920	Adjusts the horizontal position.
Position V	-1200- 0 - +1200	Adjusts the vertical position.
Brightness	-64- 0 - +63	Adjusts the brightness.
Contrast	-64- 0 - +63	Adjusts the contrast.
Saturation	-64- 0 - +63	Adjusts the saturation.
Red	-64- 0 - +63	Adjusts the red level.
Green	-64- 0 - +63	Adjusts the green level.
Blue	-64- 0 - +63	Adjusts the blue level.

(*3) The valid range of setting values depends on conditions such as the input/output format.

PinP

Menu item	Value (Bold: default)	Explanation
Background Ch	LIVE IN 1 , LIVE IN 2	Sets the channel for the background video of the inset screen.
Window Ch	LIVE IN 1, LIVE IN 2	Sets the channel for the video of the inset screen.
Window Pos H	-100.0– -25.0 – +100.0%	Adjusts the horizontal position of the inset screen.
Window Pos V	-100.0– -25.0 – +100.0%	Adjusts the vertical position of the inset screen.
Window Aspect	1:1, 3:2, 4:3, 16:9	Sets the aspect ratio of the inset screen.
Window Size	10.0– 40.0 –100.0%	Adjusts the size (zoom) of the inset screen.
Window Crop H	0.0 – +100.0%	Adjusts the horizontal size of the inset screen.
Window Crop V	0.0 – +100.0%	Adjusts the vertical size of the inset screen.
View Pos H	-100.0– 0.0 – +100.0%	Adjusts the horizontal position at which the inset screen video is shown.
View Pos V	-100.0– 0.0 – +100.0%	Adjusts the vertical position at which the inset screen video is shown.
View Zoom	100.0 –1000.0%	Adjusts the zoom of the inset screen video.
Border Color	White , Yellow, Cyan, Green, Magenta, Red, Blue, Black	Sets the border color for the inset screen video.
Border Width	Off, 1 –8	Sets the border width for the inset screen video.

SPLIT

Menu item	Value (Bold: default)	Explanation
Pattern	V-Center , H-Center, V-Stretch, H-Stretch	Sets the split composite pattern.
Center	0.0– 50.0 –100.0%	Sets the split position.
A-Ch (Left/Upper)	LIVE IN 1 , LIVE IN 2	Sets the channel for the left/upper split video.
B-Ch(Right/Lower)	LIVE IN 1, LIVE IN 2	Sets the channel for the right/lower split video.
A-Center	-25.0– 0.0 – +25.0%	Adjusts the horizontal/vertical position of the left/upper split video.
B-Center	-25.0– 0.0 – +25.0%	Adjusts the horizontal/vertical position of the right/lower split video.
Border Color	White , Yellow, Cyan, Green, Magenta, Red, Blue, Black	Sets the border color for the split.
Border Width	Off, 1 –8	Sets the border width for the split.

7: Video Output

Menu item	Value (Bold: default)	Explanation
MAIN OUTPUT	[ENTER]	Configures the OUTPUT MAIN connector side.
PREVIEW OUTPUT	[ENTER]	Configures the OUTPUT PREVIEW connector side.

MAIN OUTPUT, PREVIEW OUTPUT

Menu item	Value (Bold: default)	Explanation
Status	–	Shows the status of the OUTPUT jacks. If there is no connection, “Not Connected” is shown.
Output Format (only for MAIN OUTPUT)	1080/59.94p (50p) 1080/59.94i (50i) 720/59.94p (50p)	Sets the output format.
Output Assign (only for PREVIEW OUTPUT)	Main, Preview , Replay	Specifies the output bus that is assigned to the PREVIEW OUTPUT.
Color Space	RGB(0-255), RGB(16-235), YPbPr	Specifies the color space.
DVI-D/HDMI	HDMI , DVI-D	Specifies the output mode.
Flip Horizontal (only for MAIN OUTPUT)	Off , On	If this is set to “On,” the video is output with left and right flipped.
Brightness	-64- 0 - +63	Adjusts the brightness.
Contrast	-64- 0 - +63	Adjusts the contrast.
Saturation	-64- 0 - +63	Adjusts the saturation.
Red	-64- 0 - +63	Adjusts the red level.
Green	-64- 0 - +63	Adjusts the green level.
Blue	-64- 0 - +63	Adjusts the blue level.

8: Audio Input

Menu item	Value (Bold: default)	Explanation
LIVE IN 1	[ENTER]	Configures the audio input for LIVE IN 1.
LIVE IN 2	[ENTER]	Configures the audio input for LIVE IN 2.
AUDIO IN	[ENTER]	Configures the audio input for AUDIO IN.
LIVE IN Bus	[ENTER]	Configures the audio input for the LIVE IN bus.
REPLAY	[ENTER]	Configures the audio input for REPLAY.
AUDIO PLAYER	[ENTER]	Configures the audio player settings.

LIVE IN 1, LIVE IN 2, AUDIO IN

Menu item	Value (Bold: default)	Explanation
Level	-INF, -80.0– 0.0 – +10.0dB	Adjusts the input volume.
Mute	Off , On	Turns the mute function on/off. If this is set to “On,” the input audio is temporarily muted.
Delay	0.0 –95.0ms (0.0 –5.6/4.7Frame)	Adjusts the delay time of the audio. * The range for the frame rate setting differs depending on the Frame Rate setting (59.97Hz/50Hz). Effect Delays the output of the effect audio.
HPF 75Hz	Off , On	Turns the high-pass filter on/off. Effect Cuts off low-band audio not required for the effect. The cutoff frequency is 75 Hz.
Send to (only for AUDIO IN)	LIVE IN Bus , Input Bus	Sets whether to mix the AUDIO IN audio with the LIVE IN bus, or whether to mix it with the Input bus.
Gate	Off , On	Turns the noise gate on/off. Effect Eliminates audio that is lower than the specified threshold level.
Threshold	-80.0– 50 –0.0dB	Specifies the base level used as the threshold for removing audio. Audio below the level set here is removed.
Release	30– 860 –5000ms	Adjusts the length of time until the audio is fully attenuated after the audio level falls below the threshold.
Compressor	Off , On	Turns the compressor on/off. Effect Audio that exceeds the specified effect threshold level is compressed.
Threshold	-50– 8 –0dB	Specifies the base level at which the compressor is applied. Compression is applied to audio that exceeds the threshold.
Ratio	1.00:1, 1.12:1, 1.25:1, 1.40:1, 1.60:1, 1.80:1, 2.00:1, 2.50:1 , 3.20:1, 4.00:1, 5.60:1, 8.00:1, 16.0:1, INF:1	Specifies the degree of compression applied to the audio. The state in which no compression is applied is defined as “1.”
Attack	0– 3.0 –100ms	Specifies the time until compression starts when audio exceeding the threshold is input.
Release	30– 250 –5000ms	Adjusts the length of time until compression ends after audio falls below the threshold.
Makeup Gain	-40– 0 –40dB	Adjusts the final output volume level after applying the compressor.
EQ	Off , On	Turns the equalizer on/off. Effect Adjusts the volume for each frequency band.
Hi Gain	-15.0– 0.0 –15.0dB	Boosts or attenuates the high band.
Hi Freq	1.0kHz– 10.0kHz –20.0kHz	Adjusts the center frequency when changing the volume in the high band.
Mid Gain	-15.0– 0.0 –15.0dB	Boosts or attenuates the midrange band.
Mid Freq	20Hz– 500Hz –20.0kHz	Adjusts the center frequency when changing the volume in the midrange band.
Mid Q	0.5– 1.0 –16.0	Adjusts the frequency bandwidth when boosting or attenuating the midrange band.
Lo Gain	-15.0– 0.0 –15.0dB	Boosts or attenuates the low band.
Lo Freq	20Hz– 100Hz –2.0kHz	Adjusts the center frequency when changing the volume in the low band.

LIVE IN Bus

Menu item	Value (Bold: default)	Explanation
Level	-INF, -80.0- 0.0 -10.0dB	Adjusts the input volume.
Mute	Off , On	Turns the mute function on/off. If this is set to "On," the input audio is temporarily muted.
Preview Send	-INF, -80.0- 0.0 -10.0dB	Adjusts the output volume sent through the OUTPUT PREVIEW connector.
Preview Mute	Off , On	Turns the mute function on/off for signals going to the OUTPUT PREVIEW connector. If this is set to "On," the input audio is temporarily muted.

REPLAY

Menu item	Value (Bold: default)	Explanation
Level	-INF, -80.0- 0.0 -10.0dB	Adjusts the input volume.
Mute	Off , On	Turns the mute function on/off. If this is set to "On," the input audio is temporarily muted.
Preview Send	-INF, -80.0- 0.0 -10.0dB	Adjusts the output volume sent through the OUTPUT PREVIEW connector.
Preview Mute	Off , On	Turns the mute function on/off for signals going to the OUTPUT PREVIEW connector. If this is set to "On," the input audio is temporarily muted.

AUDIO PLAYER

Menu item	Value (Bold: default)	Explanation
Level	-INF, -80.0- 0.0 -10.0dB	Adjusts the input volume.
Mute	Off , On	Turns the mute function on/off. If this is set to "On," the input audio is temporarily muted.

9: Audio Output

Menu item	Value (Bold: default)	Explanation
Output Assign	[ENTER]	Configures the audio bus to which each connector outputs.
Main Bus	[ENTER]	Configures the Main audio output bus.
Preview Bus	[ENTER]	Configures the Preview audio output bus.

Output Assign

Menu item	Value (Bold: default)	Explanation
PREVIEW OUT	Specifies the audio bus that is assigned to the PREVIEW OUT connector.	
	Main	Outputs the audio of the Main bus.
	Preview	Outputs the audio of the Preview bus.
AUDIO OUT	Specifies the audio bus that is assigned to the AUDIO OUT connector.	
	Main	Outputs the audio of the Main bus.
	Preview	Outputs the audio of the Preview bus.
PHONES OUT	Specifies the audio bus that is assigned to the PHONES connector.	
	Main	Outputs the audio of the Main bus.
	Preview	Outputs the audio of the Preview bus.

Main Bus

Menu item	Value (Bold: default)	Explanation
Level	-INF, -80.0- 0.0 -10.0dB	Adjusts the output volume.
Mute	Off , On	Turns the mute function on/off. If this is set to "On," the output audio is temporarily muted.
Delay	0.0 -95.0ms (0.0-5.6/4.7Frame)	Adjusts the delay time of the audio. * The range for the frame rate setting differs depending on the Frame Rate setting (59.97Hz/50Hz). Effect Delays the output of the effect audio.
Limiter	Off , On	Turns the limiter on/off. Effect Limits the output volume so that it does not exceed the specified effect threshold level.
Threshold	-40-- 6 -0dB	Specifies the base level at which the limiter is applied. Compression is applied to audio that exceeds the threshold. The volume level of audio that is output is limited so as to stay to below the threshold.
EQ	Off , On	Turns the equalizer on/off. Effect Adjusts the volume for each frequency band.
Hi Gain	-15.0- 0.0 -15.0dB	Boosts or attenuates the high band.
Hi Freq	1.0kHz- 10.0kHz -20.0kHz	Adjusts the center frequency when changing the volume in the high band.
Mid Gain	-15.0- 0.0 -15.0dB	Boosts or attenuates the midrange band.
Mid Freq	20Hz- 500Hz -20.0kHz	Adjusts the center frequency when changing the volume in the midrange band.
Mid Q	0.5- 1.0 -16.0	Adjusts the frequency bandwidth when boosting or attenuating the midrange band.
Lo Gain	-15.0- 0.0 -15.0dB	Boosts or attenuates the low band.
Lo Freq	20Hz- 100Hz -2.0kHz	Adjusts the center frequency when changing the volume in the low band.

Preview Bus

Menu item	Value (Bold: default)	Explanation
Level	-INF, -80.0- 0.0 -10.0dB	Adjusts the output volume.
Mute	Off , On	Turns the mute function on/off. If this is set to "On," the output audio is temporarily muted.
Delay	0.0 -95.0ms (0.0-5.6/4.7Frame)	Adjusts the delay time of the audio. * The range for the frame rate setting differs depending on the Frame Rate setting (59.97Hz/50Hz). Effect Delays the output of the effect audio.
Limiter	Off , On	Turns the limiter on/off. Effect Limits the output volume so that it does not exceed the specified effect threshold level.
Threshold	-40.0- -6.0 -0.0dB	Specifies the base level at which the limiter is applied. Compression is applied to audio that exceeds the threshold. The volume level of audio that is output is limited so as to stay to below the threshold.

10: Audio Rec Level

Menu item	Value (Bold: default)	Explanation
Level	-INF, -80.0– 0.0 –10.0dB	Adjusts the output volume.
Mute	Off , On	Turns the mute function on/off. If this is set to "On," the output audio is temporarily muted.

11: SD Card/USB Memory

Menu item	Value (Bold: default)	Explanation
SD Card	–	–
Eject	[ENTER]	Safely ejects and allows you to remove the SD card.
Format	[ENTER]	Formats an inserted SD card.
Speed Test	[ENTER]	Measures the data write speed to the SD card.
USB Memory	–	–
Eject	[ENTER]	Safely ejects and allows you to remove the USB storage.
Load Settings	[ENTER]	Loads a settings file saved on a SD card or USB storage back into this unit.
Save Settings	[ENTER]	Saves the settings of this unit by overwriting an existing file on an SD card or USB storage.
Save Settings As	[ENTER]	Save the settings of this unit with a name you specify to an SD card or USB storage.

12: Annotation

Menu item	Value (Bold: default)	Explanation
Switch	Off , On	Turns annotation on/off.
Cursor Display	Off, On, Auto	Sets whether to show or hide the pen cursor. When set to "Auto," this is automatically determined by the type of pen tablet that's connected.
Calibration	[Exec]	Calibrates the display. Under the following conditions, the display is grayed out and calibrate can't be performed. <ul style="list-style-type: none"> • When Switch is "Off" • When a tablet is not connected • When a tablet without an LCD display is connected

13: Ctl/Exp

Menu item	Value (Bold: default)	Explanation
Ctl/Exp 1	[Enter]	These settings for the footswitch or expression pedal connected to the CTL/EXP 1 jack.
Ctl/Exp 2	[Enter]	These settings for the footswitch or expression pedal connected to the CTL/EXP 2 jack.

Ctl/Exp 1, Ctl/Exp 2

Menu item	Value (Bold: default)	Explanation
Ctl/Exp Type	Settings for the devices (footswitch or expression pedal) connected to the CTL/EXP 1, 2 jacks.	
	Off	Disables the CTL/EXP jack.
	Ctl A & Ctl B	Choose this if a footswitch is connected.
	Exp	Choose this if an expression pedal is connected.
Ctl A Assign (*4) Ctl B Assign (*4)	Specifies the functions that are assigned to CTL A and CTL B of the footswitch.	
	N/A	No function is assigned.
	INPUT SELECT	Switches the final input video.
	REC Start	Starts recording.
	REC Stop	Stops recording.
	Mark IN	Sets the IN point.
	Mark OUT	Sets the OUT point.
	MAKE CLIP	Creates a clip whose OUT point is the moment at which you depress the footswitch.
	Select Prev Clip	Selects the clip just before the currently selected clip.
	Select Next Clip	Selects the next clip after the currently selected clip.
	AUTO PLAY CLIP	Plays back the clip.
	AUTO PLAY PLAYLIST	Plays back the playlist.
	Add BOOKMARK	Adds a bookmark.
	Jump to Prev BOOKMARK	Jumps to the previous bookmark.
	Jump to Next BOOKMARK	Jumps to the next bookmark.
Jump to Top	Jumps to the beginning of the recorded video.	
Jump to End	Jumps to the end of the recorded video.	
Exp Assign (*5)	Specifies the function that is assigned to the expression pedal.	
	N/A	No function is assigned.
	Speed Control	Adjusts the playback speed.
	LIVE IN ► REPLAY	Switches between the live in video (when the pedal is pushed up with your toes) and the replay video (when the pedal is pushed down with your heel).
	REPLAY ► LIVE IN	Switches between the replay video (when the pedal is pushed up with your toes) and the live in video (when the pedal is pushed down with your heel).
AUDIO OUTPUT LEVEL	Adjusts the output level of the main bus.	
Exp Calibration (*5)	[Enter]	Calibrate (adjust) the expression pedal. The first time you use the expression pedal, be sure to execute calibration so that the pedal will operate optimally. In some cases, the expression pedal might no longer be operating optimally because of the passage of time or the conditions of use. In such cases you should also execute expression pedal calibration.

(*4) This is valid when Ctl/Exp Type is set to "Ctl A & Ctl B."

(*5) This is valid when Ctl/Exp Type is set to "Exp."

14: RS-232

Menu item	Value (Bold: default)	Explanation
Baudrate	9600 , 38400bps	Specifies the communication speed (bps) of the RS-232 connector.
Remote Control	This sets how the remote control is used.	
	Off	Disables remote control.
	PC	Remotely controls the P-20HD from a controlling device such as your computer.
	Switcher	Synchronizes playback of the clip or playlist on the P-20HD with the video transition on your Roland video switcher.
Target Model (*5)	V-60HD	Sets the video switcher used to synchronize with the P-20HD.
Input Channel (*5)	Ch5, Ch6	Select the channel of the video switcher to which the P-20HD video is input.
Host/Remote (*5)	Host , Remote	Sets whether the P-20HD acts as the host (operating other devices) or the remote (being operated by other devices).
Time Offset at Play Start (*6) (*7)	0– 40 –200ms	Adjusts how long it takes before the video transition starts on the other video switcher after the clip or playlist starts playing back on the P-20HD.
Time Offset at Play End (*6) (*7)	-200– 40 –0ms	Adjust the time it takes before the video transition starts, so that the video transition finishes on the other video switcher when the clip or playlist stops playing back on the P-20HD.

(*6) This can be set if Remote Control is "Switcher."

(*7) This can be set if Host/Remote is "Host."

15: LAN

Menu item	Value (Bold: default)	Explanation	
IP Setting	Selects how settings are made for the IP address, subnet mask, and default gateway.		
	Off	Disables the network connection.	
	Using DHCP	The IP address and other information needed for connecting to the network is obtained automatically from the DHCP server of the LAN.	
	Manually	This is to be configured manually.	
	IP Address (*8)	---.---.---.---	Specifies the IP address as appropriate for the network to which the unit is connected.
	Subnet Mask (*8)	---.---.---.---	Specifies the subnet mask as appropriate for the network to which the unit is connected.
	Gateway (*8)	---.---.---.---	Specifies the default gateway as appropriate for the network to which the unit is connected.
MAC Address	00:00:00:00:00:00 (example display)	Displays the MAC address.	
User Account	This configures the necessary user account to connect to the network.		
User ID	–	Sets the user ID (4–8 characters).	
Password	–	Sets the password (8–12 characters). * When you set a different password, there is no need to input the old password or perform a reset operation. * If a password has been set, "*****" is displayed.	
Reset	[Exec]	Resets the user ID and password.	
Remote Control	Off , On	When this is set to "On," the unit receives remote control commands from the network device.	
FTP	Off , On		
	When this is set to "On," you can access the "/P-20HD_Export" folder that's located on the SD card or USB storage device connected to the P-20HD, via FTP from your computer. You can work with the following files from your FTP client.		
	<ul style="list-style-type: none"> • Downloading/uploading an exported project archive • Downloading an exported video, EDL or FCPXML file 		
Directory (*9)	SD Card , USB Memory	Sets the media (SD card or USB storage) to access from your computer when connecting via FTP. The contents of the "/P-20HD_Export" folder on the respective storage media are shared.	
Status	Offline, Online	Displays the FTP connection status.	

(*8) This can be set if IP setting is "Manually."

(*9) This can be set if FTP is "Off."

16: System

Menu item	Value (Bold: default)	Explanation																																																																																																						
Frame Rate	59.94Hz, 50Hz	Specifies the frame rate.																																																																																																						
Date & Time Settings	[ENTER]	Sets the date and time.																																																																																																						
		<table border="1"> <thead> <tr> <th>Menu item</th> <th>Value</th> <th>Explanation</th> </tr> </thead> <tbody> <tr> <td>Date</td> <td>Year/Month/Day</td> <td>Sets the date and time.</td> </tr> <tr> <td>Time</td> <td>Hour/Minute/Sec.</td> <td>Sets the time.</td> </tr> <tr> <td>Time Zone</td> <td>(*10)</td> <td>Sets the time zone.</td> </tr> <tr> <td>Date Format</td> <td>Month / Day / Year Day / Month / Year Year / Month / Day</td> <td>Sets the format used for displaying the date.</td> </tr> </tbody> </table>	Menu item	Value	Explanation	Date	Year/Month/Day	Sets the date and time.	Time	Hour/Minute/Sec.	Sets the time.	Time Zone	(*10)	Sets the time zone.	Date Format	Month / Day / Year Day / Month / Year Year / Month / Day	Sets the format used for displaying the date.																																																																																							
		Menu item	Value	Explanation																																																																																																				
		Date	Year/Month/Day	Sets the date and time.																																																																																																				
		Time	Hour/Minute/Sec.	Sets the time.																																																																																																				
Time Zone	(*10)	Sets the time zone.																																																																																																						
Date Format	Month / Day / Year Day / Month / Year Year / Month / Day	Sets the format used for displaying the date.																																																																																																						
Startup Project	Off, On	When this is set to "On," the project automatically opens when the unit starts up.																																																																																																						
OSD Remaining Time Display	Off, On	When this is set to "On," the remaining time is shown in the preview area of the replay video when the clip or playlist is playing back.																																																																																																						
Input Select Customize	[ENTER]	This sets the selection target of the INPUT [SELECT] button. The inputs that are set to "Disable" can't be selected with the INPUT [SELECT] button.																																																																																																						
		<table border="1"> <thead> <tr> <th>Menu item</th> <th>Value</th> <th>Input</th> </tr> </thead> <tbody> <tr> <td>LIVE IN 1</td> <td>Enable, Disable</td> <td>LIVE IN 1 video</td> </tr> <tr> <td>LIVE IN 2</td> <td>Enable, Disable</td> <td>LIVE IN 2 video</td> </tr> <tr> <td>PinP</td> <td>Enable, Disable</td> <td>PinP composited video</td> </tr> <tr> <td>SPLIT</td> <td>Enable, Disable</td> <td>Split composited video</td> </tr> </tbody> </table>	Menu item	Value	Input	LIVE IN 1	Enable , Disable	LIVE IN 1 video	LIVE IN 2	Enable , Disable	LIVE IN 2 video	PinP	Enable , Disable	PinP composited video	SPLIT	Enable , Disable	Split composited video																																																																																							
		Menu item	Value	Input																																																																																																				
		LIVE IN 1	Enable , Disable	LIVE IN 1 video																																																																																																				
		LIVE IN 2	Enable , Disable	LIVE IN 2 video																																																																																																				
PinP	Enable , Disable	PinP composited video																																																																																																						
SPLIT	Enable , Disable	Split composited video																																																																																																						
Panel Lock	[ENTER]	This sets whether panel lock is enabled (On) or disabled (Off) for the controls in question.																																																																																																						
		<table border="1"> <thead> <tr> <th>Menu item</th> <th>Value</th> <th>Applicable control for panel lock</th> </tr> </thead> <tbody> <tr> <td>All</td> <td>Off, On</td> <td>All controls in the Panel Lock menu</td> </tr> <tr> <td>REC Button</td> <td>Off, On</td> <td>[REC] button</td> </tr> <tr> <td>AUDIO OUT Knob</td> <td>Off, On</td> <td>[AUDIO OUT] knob</td> </tr> <tr> <td>INPUT/OUTPUT Section</td> <td>Off, On</td> <td>Controls shown below</td> </tr> <tr> <td> INPUT SELECT Button</td> <td>Off, On</td> <td>INPUT [SELECT] button</td> </tr> <tr> <td> OUTPUT SELECT Buttons</td> <td>Off, On</td> <td>OUTPUT [LIVE IN] [REPLAY] buttons</td> </tr> <tr> <td>SPEED Control Section</td> <td>Off, On</td> <td>Controls shown below</td> </tr> <tr> <td> SPEED Lever</td> <td>Off, On</td> <td>[SPEED] lever</td> </tr> <tr> <td> SPEED RANGE Button</td> <td>Off, On</td> <td>[SPEED RANGE] button</td> </tr> <tr> <td>AUTO PLAY Section</td> <td>Off, On</td> <td>Controls shown below</td> </tr> <tr> <td> CLIP Button</td> <td>Off, On</td> <td>[CLIP] button</td> </tr> <tr> <td> PLAYLIST Button</td> <td>Off, On</td> <td>[PLAYLIST] button</td> </tr> <tr> <td>Pad Section</td> <td>Off, On</td> <td>Controls shown below</td> </tr> <tr> <td> STILL Button</td> <td>Off, On</td> <td>[STILL] button</td> </tr> <tr> <td> AUDIO Button</td> <td>Off, On</td> <td>[AUDIO] button</td> </tr> <tr> <td> CLIP LIST Button</td> <td>Off, On</td> <td>[CLIP LIST] button</td> </tr> <tr> <td> PALETTE Button</td> <td>Off, On</td> <td>[PALETTE] button</td> </tr> <tr> <td> Pads</td> <td>Off, On</td> <td>Pads [1]–[8]</td> </tr> <tr> <td> Page Buttons</td> <td>Off, On</td> <td>[<] [>] button</td> </tr> <tr> <td>MARKER Section</td> <td>Off, On</td> <td>Controls shown below</td> </tr> <tr> <td> LIVE IN Button</td> <td>Off, On</td> <td>[LIVE IN] button</td> </tr> <tr> <td> DELETE Button</td> <td>Off, On</td> <td>[PALETTE] button</td> </tr> <tr> <td> Mark IN Button</td> <td>Off, On</td> <td>MARKER [IN] button</td> </tr> <tr> <td> Mark OUT Button</td> <td>Off, On</td> <td>MARKER [OUT] button</td> </tr> <tr> <td> BOOKMARK Button</td> <td>Off, On</td> <td>[BOOKMARK] button</td> </tr> <tr> <td> MAKE CLIP Button</td> <td>Off, On</td> <td>[MAKE CLIP] button</td> </tr> <tr> <td>Transport Control Section</td> <td>Off, On</td> <td>Controls shown below</td> </tr> <tr> <td> Marker Jump Buttons</td> <td>Off, On</td> <td>[I◀] [▶I] buttons</td> </tr> <tr> <td> Play/Pause Buttons</td> <td>Off, On</td> <td>[▶] [⏸] buttons</td> </tr> <tr> <td> JOG Button</td> <td>Off, On</td> <td>[JOG] button</td> </tr> <tr> <td> SHUTTLE Button</td> <td>Off, On</td> <td>[SHUTTLE] button</td> </tr> <tr> <td> JOG/SHUTTLE Wheel</td> <td>Off, On</td> <td>[JOG/SHUTTLE] dial (turn)</td> </tr> <tr> <td> JOG/SHUTTLE Push Button</td> <td>Off, On</td> <td>[JOG/SHUTTLE] dial (press)</td> </tr> </tbody> </table>	Menu item	Value	Applicable control for panel lock	All	Off , On	All controls in the Panel Lock menu	REC Button	Off , On	[REC] button	AUDIO OUT Knob	Off , On	[AUDIO OUT] knob	INPUT/OUTPUT Section	Off , On	Controls shown below	INPUT SELECT Button	Off , On	INPUT [SELECT] button	OUTPUT SELECT Buttons	Off , On	OUTPUT [LIVE IN] [REPLAY] buttons	SPEED Control Section	Off , On	Controls shown below	SPEED Lever	Off , On	[SPEED] lever	SPEED RANGE Button	Off , On	[SPEED RANGE] button	AUTO PLAY Section	Off , On	Controls shown below	CLIP Button	Off , On	[CLIP] button	PLAYLIST Button	Off , On	[PLAYLIST] button	Pad Section	Off , On	Controls shown below	STILL Button	Off , On	[STILL] button	AUDIO Button	Off , On	[AUDIO] button	CLIP LIST Button	Off , On	[CLIP LIST] button	PALETTE Button	Off , On	[PALETTE] button	Pads	Off , On	Pads [1]–[8]	Page Buttons	Off , On	[<] [>] button	MARKER Section	Off , On	Controls shown below	LIVE IN Button	Off , On	[LIVE IN] button	DELETE Button	Off , On	[PALETTE] button	Mark IN Button	Off , On	MARKER [IN] button	Mark OUT Button	Off , On	MARKER [OUT] button	BOOKMARK Button	Off , On	[BOOKMARK] button	MAKE CLIP Button	Off , On	[MAKE CLIP] button	Transport Control Section	Off , On	Controls shown below	Marker Jump Buttons	Off , On	[I◀] [▶I] buttons	Play/Pause Buttons	Off , On	[▶] [⏸] buttons	JOG Button	Off , On	[JOG] button	SHUTTLE Button	Off , On	[SHUTTLE] button	JOG/SHUTTLE Wheel	Off , On	[JOG/SHUTTLE] dial (turn)	JOG/SHUTTLE Push Button	Off , On	[JOG/SHUTTLE] dial (press)
Menu item	Value	Applicable control for panel lock																																																																																																						
All	Off , On	All controls in the Panel Lock menu																																																																																																						
REC Button	Off , On	[REC] button																																																																																																						
AUDIO OUT Knob	Off , On	[AUDIO OUT] knob																																																																																																						
INPUT/OUTPUT Section	Off , On	Controls shown below																																																																																																						
INPUT SELECT Button	Off , On	INPUT [SELECT] button																																																																																																						
OUTPUT SELECT Buttons	Off , On	OUTPUT [LIVE IN] [REPLAY] buttons																																																																																																						
SPEED Control Section	Off , On	Controls shown below																																																																																																						
SPEED Lever	Off , On	[SPEED] lever																																																																																																						
SPEED RANGE Button	Off , On	[SPEED RANGE] button																																																																																																						
AUTO PLAY Section	Off , On	Controls shown below																																																																																																						
CLIP Button	Off , On	[CLIP] button																																																																																																						
PLAYLIST Button	Off , On	[PLAYLIST] button																																																																																																						
Pad Section	Off , On	Controls shown below																																																																																																						
STILL Button	Off , On	[STILL] button																																																																																																						
AUDIO Button	Off , On	[AUDIO] button																																																																																																						
CLIP LIST Button	Off , On	[CLIP LIST] button																																																																																																						
PALETTE Button	Off , On	[PALETTE] button																																																																																																						
Pads	Off , On	Pads [1]–[8]																																																																																																						
Page Buttons	Off , On	[<] [>] button																																																																																																						
MARKER Section	Off , On	Controls shown below																																																																																																						
LIVE IN Button	Off , On	[LIVE IN] button																																																																																																						
DELETE Button	Off , On	[PALETTE] button																																																																																																						
Mark IN Button	Off , On	MARKER [IN] button																																																																																																						
Mark OUT Button	Off , On	MARKER [OUT] button																																																																																																						
BOOKMARK Button	Off , On	[BOOKMARK] button																																																																																																						
MAKE CLIP Button	Off , On	[MAKE CLIP] button																																																																																																						
Transport Control Section	Off , On	Controls shown below																																																																																																						
Marker Jump Buttons	Off , On	[I◀] [▶I] buttons																																																																																																						
Play/Pause Buttons	Off , On	[▶] [⏸] buttons																																																																																																						
JOG Button	Off , On	[JOG] button																																																																																																						
SHUTTLE Button	Off , On	[SHUTTLE] button																																																																																																						
JOG/SHUTTLE Wheel	Off , On	[JOG/SHUTTLE] dial (turn)																																																																																																						
JOG/SHUTTLE Push Button	Off , On	[JOG/SHUTTLE] dial (press)																																																																																																						
		* Long-press the [MENU] button (for at least three seconds) while holding down the [VALUE] knob to toggle panel lock on/off.																																																																																																						
LED Dimmer	1–8	Adjusts the brightness of the LEDs.																																																																																																						

Menu item	Value (Bold: default)	Explanation
LCD Dimmer	1–8	Adjusts the brightness of this unit's display.
Date Display	Off, On	Sets whether the date is shown (On) or not shown (Off) in the preview screen.
Time Display Format	Hour:Min, Hour:Min:Sec, Hour:Min am/pm, Hour:Min:Sec am/pm	Sets the format used for the time shown in the preview screen.
Test Pattern	Off, 75% Color Bar, 100% Color Bar, Ramp, Step, Hatch	Specifies the test pattern.
Test Tone	Off, 20dB@1kHz, -10dB@1kHz, 0dB@1kHz	Specifies the test tone.
Auto Off	Off, On	Turns the Auto Off function on/off. If this is set to "On," the power to the P-20HD turns off automatically when all of the following applies for at least 240 minutes. <ul style="list-style-type: none"> • No operation performed on the unit • No audio or video input • No equipment connected to the OUTPUT jacks
Shutdown	[Exec]	Use this when you want to turn the power on/off with an AC power strip or the like.
Factory Reset	[Exec]	Returns the unit to its factory defaults.
Version	–	Displays the version of the system program.

(*10)

Africa	Abidjan, Accra, Addis_Ababa, Algiers, Asmara, Bamako, Bangui, Banjul, Bissau, Blantyre, Brazzaville, Bujumbura, Cairo, Casablanca, Ceuta, Conakry, Dakar, Dar_es_Salaam, Djibouti, Douala, El_Aaiun, Freetown, Gaborone, Harare, Johannesburg, Juba, Kampala, Khartoum, Kigali, Kinshasa, Lagos, Libreville, Lome, Luanda, Lubumbashi, Lusaka, Malabo, Maputo, Maseru, Mbabane, Mogadishu, Monrovia, Nairobi, Ndjamena, Niamey, Nouakchott, Ouagadougou, Porto-Novo, Sao_Tome, Tripoli, Tunis, Windhoek
America	Adak, Anchorage, Anguilla, Antigua, Araguaina, Argentina/Buenos_Aires, Argentina/Catamarca, Argentina/Cordoba, Argentina/Jujuy, Argentina/La_Rioja, Argentina/Mendoza, Argentina/Rio_Gallegos, Argentina/Salta, Argentina/San_Juan, Argentina/San_Luis, Argentina/Tucuman, Argentina/Ushuaia, Aruba, Asuncion, Atikokan, Bahia, Bahia_Banderas, Barbados, Belem, Belize, Blanc-Sablon, Boa_Vista, Bogota, Boise, Cambridge_Bay, Campo_Grande, Cancun, Caracas, Cayenne, Cayman, Chicago, Chihuahua, Costa_Rica, Creston, Cuiaba, Curacao, Danmarkshavn, Dawson, Dawson_Creek, Denver, Detroit, Dominica, Edmonton, Eirunepe, El_Salvador, Fort_Nelson, Fortaleza, Glace_Bay, Goose_Bay, Grand_Turk, Grenada, Guadeloupe, Guatemala, Guayaquil, Guyana, Halifax, Havana, Hermosillo, Indiana/Indianapolis, Indiana/Knox, Indiana/Marengo, Indiana/Petersburg, Indiana/Tell_City, Indiana/Vevay, Indiana/Vincennes, Indiana/Winamac, Inuvik, Iqaluit, Jamaica, Juneau, Kentucky/Louisville, Kentucky/Monticello, Kralendijk, La_Paz, Lima, Los_Angeles, Lower_Princes, Maceio, Managua, Manaus, Marigot, Martinique, Matamoros, Mazatlan, Menominee, Merida, Metlakatla, Mexico_City, Miquelon, Moncton, Monterrey, Montevideo, Montserrat, Nassau, New_York, Nipigon, Nome, Noronha, North_Dakota/Beulah, North_Dakota/Center, North_Dakota/New_Salem, Nuuk, Ojinaga, Panama, Pangnirtung, Paramaribo, Phoenix, Port-au-Prince, Port_of_Spain, Porto_Velho, Puerto_Rico, Punta_Arenas, Rainy_River, Rankin_Inlet, Recife, Regina, Resolute, Rio_Branco, Santarem, Santiago, Santo_Domingo, Sao_Paulo, Scoresbysund, Sitka, St_Barthelemy, St_Johns, St_Kitts, St_Lucia, St_Thomas, St_Vincent, Swift_Current, Tegucigalpa, Thule, Thunder_Bay, Tijuana, Toronto, Tortola, Vancouver, Whitehorse, Winnipeg, Yakutat, Yellowknife
Antarctica	Casey, Davis, DumontDURville, Macquarie, Mawson, McMurdo, Palmer, Rothera, Syowa, Troll, Vostok
Arctic	Longyearbyen
Asia	Aden, Almaty, Amman, Anadyr, Aqtau, Aqtobe, Ashgabat, Atyrau, Baghdad, Bahrain, Baku, Bangkok, Barnaul, Beirut, Bishkek, Brunei, Chita, Choibalsan, Colombo, Damascus, Dhaka, Dili, Dubai, Dushanbe, Famagusta, Gaza, Hebron, Ho_Chi_Minh, Hong_Kong, Hovd, Irkutsk, Jakarta, Jayapura, Jerusalem, Kabul, Kamchatka, Karachi, Kathmandu, Khandyga, Kolkata, Krasnoyarsk, Kuala_Lumpur, Kuching, Kuwait, Macau, Magadan, Makassar, Manila, Muscat, Nicosia, Novokuznetsk, Novosibirsk, Omsk, Oral, Phnom_Penh, Pontianak, Pyongyang, Qatar, Qostanay, Qyzylorda, Riyadh, Sakhalin, Samarkand, Seoul, Shanghai, Singapore, Srednekolymysk, Taipei, Tashkent, Tbilisi, Tehran, Thimphu, Tokyo, Tomsk, Ulaanbaatar, Urumqi, Ust-Nera, Vientiane, Vladivostok, Yakutsk, Yangon, Yekaterinburg, Yerevan
Atlantic	Azores, Bermuda, Canary, Cape_Verde, Faroe, Madeira, Reykjavik, South_Georgia, St_Helena, Stanley
Australia	Adelaide, Brisbane, Broken_Hill, Currie, Darwin, Eucla, Hobart, Lindeman, Lord_Howe, Melbourne, Perth, Sydney
Europe	Amsterdam, Andorra, Astrakhan, Athens, Belgrade, Berlin, Bratislava, Brussels, Bucharest, Budapest, Busingen, Chisinau, Copenhagen, Dublin, Gibraltar, Guernsey, Helsinki, Isle_of_Man, Istanbul, Jersey, Kaliningrad, Kiev, Kirov, Lisbon, Ljubljana, London, Luxembourg, Madrid, Malta, Mariehamn, Minsk, Monaco, Moscow, Oslo, Paris, Podgorica, Prague, Riga, Rome, Samara, San_Marino, Sarajevo, Saratov, Simferopol, Skopje, Sofia, Stockholm, Tallinn, Tirane, Ulyanovsk, Uzhgorod, Vaduz, Vatican, Vienna, Vilnius, Volgograd, Warsaw, Zagreb, Zaporozhye, Zurich
Indian	Antananarivo, Chagos, Christmas, Cocos, Comoro, Kerguelen, Mahe, Maldives, Mauritius, Mayotte, Reunion
Pacific	Apia, Auckland, Bougainville, Chatham, Chuuk, Easter, Efate, Enderbury, Fakaofu, Fiji, Funafuti, Galapagos, Gambier, Guadalcanal, Guam, Honolulu, Kiritimati, Kosrae, Kwajalein, Majuro, Marquesas, Midway, Nauru, Niue, Norfolk, Noumea, Pago_Pago, Palau, Pitcairn, Pohnpei, Port_Moresby, Rarotonga, Saipan, Tahiti, Tarawa, Tongatapu, Wake, Wallis
UTC	–

CLIP LIST

Menu item	Value (Bold: default)	Explanation
Name	–	Give the clip a name.
In Position	hour:mminutes:seconds:frames (at 59.94 Hz) hour:mminutes:seconds:frames (at 50Hz)	Shows the IN point.
Out Position	hour:mminutes:seconds:frames (at 59.94Hz) hour:mminutes:seconds:frames (at 50Hz)	Shows the OUT point.
Duration	–	Shows the length of the clip.
Update Thumbnail	[Exec]	Sets the thumbnail.
Add to PALETTE	[ENTER]	Registers a clip to a palette.
Color	Off , Red, Orange, Yellow, Lime, Green, Blue, Navy, Violet	Set the color of the label that's shown in the clip area.
Move to	[ENTER]	Moves the clip.
Delete	[Exec]	Deletes a clip.
Export (mp4)	[Exec]	Converts the clip in the clip list to an MP4 (.mp4) file, and exports this data to an SD card or to USB storage. * Each exported video file is saved to the "/P-20HD_Export" folder on your SD card or USB storage.
Ref Info	[ENTER]	Shows which the clip is assigned to the palettes.

PALETTE

Menu item	Value (Bold: default)	Explanation
Name	–	Give the clip a name.
In Position	hour:mminutes:seconds:frames (at 59.94 Hz) hour:mminutes:seconds:frames (at 50Hz)	Shows the IN point.
Out Position	hour:mminutes:seconds:frames (at 59.94Hz) hour:mminutes:seconds:frames (at 50Hz)	Shows the OUT point.
Duration	–	Shows the length of the clip.
Update Thumbnail	[Exec]	Sets the thumbnail.
Color	Off , Red, Orange, Yellow, Lime, Green, Blue, Navy, Violet	Set the color of the label that's shown in the clip area.
Move to	[ENTER]	Moves the clip.
Delete	[Exec]	Deregisters the clip from a palette.
Export (mp4)	[Exec]	Converts the clips in the palette to an MP4 (.mp4) file, and exports this data to an SD card or to USB storage. * Each exported video file is saved to the "/P-20HD_Export" folder on your SD card or USB storage.
Ref Info	[ENTER]	Shows the reference source information and the registration information in other palettes of the clip.

STILL

Menu item	Value (Bold: default)	Explanation
Import	[ENTER]	Imports a still image.
Name	–	Sets the name for a still image clip.
File	(File name)	Shows the filename.
Alpha Channel	Yes, No	Shows whether the image has an alpha channel.
On/Off	Sets what happens when the still image clip plays back.	
	Latch	The still image clip switches between showing or hiding, with each press of the button.
	Momentary	The clip shows only while the button is pressed.
In Transition	Off , Wipe, Slide, Fade	Sets the type of effect used when displaying the still image clip.
Time	0.0– 0.5 –1.0sec	Sets the time used when the still image clip plays back.
Direction	Left , Right, Up, Down	Sets the direction of motion when the still image clip plays back. When “In Transition” is set to “Fade,” no effect is applied.
Out Transition	Off , Wipe, Slide, Fade	Sets the type of effect used when wiping the still image clip that’s displayed.
Time	0.0– 0.5 –1.0sec	Sets the time for wiping the still image clip that’s displayed.
Direction	Left, Right , Up, Down	Sets the direction for wiping the displayed still image clip. When “Out Transition” is set to “Fade,” no effect is applied.
Swap with	[ENTER]	Swaps the position of still image clips.
Delete	[Exec]	Deletes a still image clip.
Color	Off , Red, Orange, Yellow, Lime, Green, Blue, Navy, Violet	Set the color of the label that’s shown in the clip area.

AUDIO

Menu	Value (Bold: default)	Explanation
Import	[ENTER]	Imports an audio file.
Name	–	Sets the name of an audio clip.
File	xxxx.wav	Shows the filename.
Duration	-	Shows the length of an audio clip.
Level	-INF– 0.0 –10.0dB	Sets the volume of an audio clip.
On/Off	Sets what happens when the audio clip plays back.	
	Latch	Each time the button is pressed, the audio clip switches between playing back and stopping.
	Momentary	The audio clip plays back only while the button is pressed.
Offset	0.0 –10.0s	Sets the playback start position of the audio clip.
Fade In	Off , 0.1–10.0sec	Sets the fade-in time.
Fade Out	Off , 0.1–10.0sec	Sets the fade-out time.
Loop	Off , On	When this is set to “On,” the audio clip plays back in a loop.
Swap with	[ENTER]	Swaps the position of audio clips.
Delete	[Exec]	Deletes an audio clip.
Color	Off , Red, Orange, Yellow, Lime, Green, Blue, Navy, Violet	Set the color of the label that’s shown in the clip area.

List of Shortcut Keys

The following items let you use shortcut operations to display other items, or perform direct operations without going to the menu.

Action	Operation
Recording stop	Hold down the [EXIT] button and press the [REC] button.
Switch input	Hold down the [EXIT] button and press the INPUT [SELECT] button. Once you release the [EXIT] button, the input is switched.
Panel lock on/off	Hold down the [VALUE] knob and long-press the [MENU] button (for at least three seconds).
STILL Pad menu display	Hold down the [STILL] button and press the [MENU] button.
AUDIO Pad menu display	Hold down the [AUDIO] button and press the [MENU] button.
CLIP LIST Pad menu display	Hold down the [CLIP LIST] button and press the [MENU] button.
PALETTE Pad menu display for the current palette	Hold down the [PALETTE] button and press the [MENU] button.
Change a setting value by a larger amount	When editing the value, turn the [VALUE] knob while holding it down.
Initialize a setting value	When editing the value, long-press the [VALUE] knob.
Display the still image clip menu	Move the cursor to the still image clip and press the [VALUE] knob.
Display the audio clip menu	Move the cursor to the audio clip and press the [VALUE] knob.
Display the clip menu	Move the cursor to the clip and press the [VALUE] knob.
Removing the SD Card	Hold down the [EXIT] button and press the [MENU] button.
Deleting a specified clip	While the clip list/palette is shown, press the MARKER [DELETE] button while holding down pads [1]–[8].
Deleting the current clip	While the clip list is shown, press the MARKER [DELETE] button while holding down the [CLIP LIST] button.
Deleting the current clip	While the palette is shown, press the MARKER [DELETE] button while holding down the [PALETTE] button.
Register specified clip in the current palette	While the clip list is shown, press the [PALETTE] button while holding down pads [1]–[8].
Register current clip in the current palette	While the clip list is shown, press the MARKER [PALETTE] button while holding down the [CLIP LIST] button.
Start playlist from specified clip	While the clip list/palette is shown, press the [PLAYLIST] button while holding down pads [1]–[8].
Move continuously between pages	Long-press the [<] or [>] button.
Jump continuously through bookmarks Keep pressing to jump to beginning/end	Long-press the [I◀] or [▶I] button.
Jump to beginning/end of timeline	Hold down the [EXIT] button and press the [I◀] or [▶I] button.
Jump to beginning/end of page	Hold down the [EXIT] button and press the [PAGE DEC] or [PAGE INC] button.
Cue up the first clip	While the clip list/palette is shown, press the MARKER [PLAYLIST] button while holding down the [EXIT] button.
Switch between menu screen pages	Hold down the [MENU] button and turn the [VALUE] knob.

Remote Control Commands (LAN/RS-232)

Command format

Commands are formatted using the configuration shown below. Commands are all in ASCII code.

```
stx Command code : Parameter , Parameter ;
```

stx	ASCII code "02H" is a control code indicating the start of a command. "H" indicates that it is a hexadecimal value.
Command code	This specifies the command type (three single-byte alphanumeric characters).
Parameter	This is appended to a command that requires one or more parameter. The command and the parameter portion are separated by a ":" (colon). When there are multiple parameters, they are each separated by "," (comma) characters.
;	This is the code that this unit recognizes as the end of a command.

* The codes of stx (02H) and ack (06H) are the control codes.

Network

*Only when connected to a LAN

Item	Sent command	Response command	Parameter
Input user ID (authentication)	stxUSR:a;	ACK	
Input password (authentication)	stxPSS:a;	ACK	
		NACK	If authentication fails
End communication	stxQIT;	ACK	

Operation

Item	Sent command	Response command	Parameter	
Recording start	stxREC;	ACK		
Recording stop	stxRES;	ACK		
Playback start	stxPLY;	ACK		
Pause	stxPUS;	ACK		
Jog operations	stxJOG:a;	ACK	a: 1 (forward), -1 (reverse)	
Shuttle operations	stxSHT:a;	ACK	a: -8 (x-128), -7 (x-64), -6 (x-32), -5 (x-16), -4 (x-8), -3 (x-4), -2 (x-2), -1 (x-1), 0 (x0), 1 (x1), 2 (x2), 3 (x4), 4 (x8), 5 (x16), 6 (x32), 7 (x64), 8 (x128)	
Change playback speed	stxSPC:a;	ACK	a: 0-100	
Switch playback speed range	stxSPR:a;	ACK	a: 0 ([SPEED RANGE] button is unlit), 1 ([SPEED RANGE] button is lit)	
IN point settings	stxMIN:a;	ACK	a: 0 (replay video), 1 (live in video)	
OUT point settings	stxMOT:a;	ACK	a: 0 (replay video), 1 (live in video)	
Clips	Create	stxMCL:a;	ACK	a: 0 (replay video), 1 (live in video)
	Select	stxCLS:a;	ACK	a: 1-512 (for clip list), 1-64 (for palette)
	Playback start	stxAPC;	ACK	
	Cue up	stxCLQ:a;	ACK	a: 1-512 (for clip list), 1-64 (for palette)
Deleting	stxCLD:a;	ACK	a: 1-512 (for clip list), 1-64 (for palette)	
Bookmark	Setting	stxBMK:a;	ACK	a: 0 (replay video), 1 (live in video)
	Deleting	stxDMK;	ACK	
Switch input	stxSLI:a;	ACK	a: 1 (LIVE IN 1), 2 (LIVE IN 2), 3 (PinP), 4 (SPLIT)	
Switch output	stxSLO:a;	ACK	a: 0 (replay video), 1 (live in video)	
Jump to the next bookmark	stxJNB;	ACK		
Jump to the previous bookmark	stxJPB;	ACK		
Timeline	Jump to the beginning	stxJTP;	ACK	
	Jump to the end	stxJED;	ACK	
Playlist	Select	stxPLS:a;	ACK	a: 0 (clip list), 1-8 (palettes 1-8)
	Playback start	stxAPL:a;	ACK	
Auto-play stop	stxSAP;	ACK		
Palette	Select	stxPLS:a;	ACK	a: 1-8 (palettes 1-8)
	Add current clip	stxATP:a;	ACK	a: 1-8 (palettes 1-8)
Still image clips	Playback	stxSTP:a;	ACK	a: 1-16 (still image clips 1-16)
	Stopping	stxSTS;	ACK	
Audio clips	Playback	stxAUP:a;	ACK	a: 1-16 (audio clips 1-16)
	Stopping	stxAUS;	ACK	
Set audio level	stxVOL:a;	ACK	a: -801 (-INFdB), -800 (-80.0 dB)-0 (0.0 dB)-100 (10.0 dB)	

System

Item	Sent command	Response command	Parameter
Request active sensing	stxACS;	ACK	
Request version information	stxVER;	stxVER:P-20HD,a;	a: Version * The version info is ASCII text strings.
Shut down this unit	stxEXT;	ACK	
Flow control	XON/XOFF	ACK	

Inquiry

Item	Sent command	Response command	Parameter
Check for open project	stxQPJ;	stxQPJ:a;	a: 0 (no project is open), 1 (project is open)
Get project recording/playback mode	stxQMD;	stxQMD:a;	a: 0 (Resolution), 1 (Frame Rate)
Get recording status	stxQRC;	stxQRC:a;	a: 0 (recording stopped), 1 (recording)
Get playback status	stxQPL;	stxQPL:a;	a: 0 (playback paused), 1 (playing back), 2 (playing back clip), 3 (playing back playlist)
Get playback speed	stxQSP;	stxQSP:a;	a: -100-100
Get playback range	stxQSR;	stxQSR:a;	a: 0 ([SPEED RANGE] button is unlit), 1 ([SPEED RANGE] button is lit)
Get IN point setting status	stxQMI;	stxQMI:a;	a: 0 (not set), 1 (set)
Get input selection status	stxQIS;	stxQIS:a;	a: 1 (LIVE IN 1), 2 (LIVE IN 2), 3 (PinP), 4 (SPLIT)
Get output selection status	stxQOS;	stxQOS:a;	a: 0 (replay video), 1 (live in video)
Get audio level	stxQAL;	stxQAL:a;	a: -801 (-INFdB), -800 (-80.0 dB)-0 (0.0 dB)-100 (10.0 dB)
Get playlist containing currently selected clip	stxQPS;	stxQPS:a;	a: 0 (clip list), 1-8 (palettes 1-8)
Get number of currently selected clip	stxQCS;	stxQCS:a;	a: 1-512 (for clip list), 1-64 (for palette)
Get playlist containing cued-up clip	stxQPQ;	stxQPQ:a;	a: 0 (clip list), 1-8 (palettes 1-8)
Get number of cued-up clip	stxQCQ;	stxQCQ:a;	a: 1-512 (for clip list), 1-64 (for palette)
Check whether clip is available in the specified position	stxQCX:a,b;	stxQCX:a,b,c;	a: 0 (clip list), 1-8 (palettes 1-8) b: 0-512 (when a=0), 0-64 (when a=1-8) c: 0 (not available), 1 (available)
Check whether audio clip is available in the specified position	stxQAX:a;	stxQAX:a,b;	a: 1-16 (audio clips 1-16) b: 0 (not available), 1 (available)
Check whether still image clip is available in the specified position	stxQSX:a;	stxQSX:a,b;	a: 1-16 (still image clips 1-16) b: 0 (not available), 1 (available)
Get number of clips in the specified playlist	stxQNC:a;	stxQNC:a,b;	a: 0 (clip list), 1-8 (palettes 1-8) b: 0-512 (when a=0), 0-64 (when a=1-8)

Commands spontaneously sent from this unit

Item	Sent command	Response command	Parameter
Error detected	stxERR:a;		a: 0 (syntax error) The received command contains an error. 4 (invalid) This has no effect because it is controlled by another setting. 5 (out of range error) An argument of the received command is out of range.
Flow control	XON/XOFF		

Appendix

Troubleshooting

If you suspect a malfunction, please check the following points.

If this does not resolve the problem, contact a nearby Roland Service Center.

Problem	Items to check	Action	Page
Video-related problems			
Cannot record video	Have you inserted an SD card?	Make sure that the SD card is inserted correctly.	p. 8
	Is the SD card locked?	Unlock the SD card before use.	p. 8
	Is the SD card formatted correctly?	Be sure to format the SD card using the P-20HD.	p. 8
	Have you opened a project?	Before recording, you must create a new project or open an existing project.	p. 14
	Is there enough storage capacity left on the SD card?	Delete any files you don't need, or use a different SD card.	p. 23
Video does not stop recording	-	Press the [REC] and [EXIT] buttons together to stop.	p. 15
No video input	Have you made the correct selection with INPUT SELECT?	Check which input is selected with INPUT SELECT.	p. 15
	Have the Video Input settings been correctly configured?	Check the Video Input settings.	p. 30
No video output	Is the display connected correctly?	Is video showing on this unit's display (LCD)? If you can see video on this unit's display, the video is also being output to the output connectors. Check the display connections.	p. 3
	Is the OUTPUT (LIVE IN or REPLAY) correctly selected?	Check the OUTPUT buttons (LIVE IN and REPLAY).	p. 16
Video does not play back	Is the [SPEED] lever in the correct position?	Check the position of the [SPEED] lever, as well as the playback speed indicator.	p. 15
	Is the unit in jog mode or shuttle mode?	Make sure that both the [JOG] button and [SHUTTLE] button are both unlit.	p. 15
Cannot create a clip	Have you recorded enough video time to make a clip?	Clips can't be created from recording data that is less than one second long.	p. 19
	Is there enough time between the IN point and OUT point?	There needs to be at least one second between the IN point and OUT point. Adjust the positions of the IN point and OUT point as necessary.	p. 19
	Is the unit still playing back a clip or playlist?	Clips can't be made while another clip or playlist is playing back.	p. 21
Playback speed does not change	Is the unit still playing back a clip or playlist?	The playback speed can't be changed while another clip or playlist is playing back.	p. 21
Audio-related problems			
Cannot play back audio files	Have you correctly imported the audio file?	Try importing the audio file in question again, and see whether it imports correctly.	p. 29
Other problems			
Cannot play a still image file	Have you correctly imported the still image file?	Try importing the still image file in question again, and see whether it imports correctly.	p. 27
Cannot use a USB flash drive	Is the USB flash drive formatted correctly?	Reformat the media on your computer in FAT32 format.	-

Error Message List

Message	Explanation
P-20HD is too hot! Please turn off the power immediately.	The internal temperature is too hot. Select [OK] and turn off the power of the P-20HD.
Fan Error! Please turn off the power immediately.	The cooling fan is not working. Select [OK] and turn off the power of the P-20HD.
SD Card Error! Recording stopped, no storage space!	The SD card has run out of free storage space. (If the storage capacity runs out while the unit is recording, this message is shown and recording stops.) Delete any files you don't need, or use a different SD card.
SD Card Error! No storage space!	The SD card has run out of free storage space. (This message is shown if there is not enough storage space.) Delete any files you don't need, or use a different SD card.
SD Card Error! No SD card inserted.	An SD card has not been inserted. Make sure that the SD card is inserted correctly.
SD Card Error! This media is write protected.	The SD card is locked. Unlock the SD card.
HDCP Error! P-20HD doesn't support HDCP.	The video is HDCP-protected, and cannot be input.
File Error! This file format is not supported.	The P-20HD does not support this file format.

Approximate Recording Times

SD card capacity	Available recording time
16 GB	2 hr 50 min
32 GB	5 hr 45 min
64 GB	11 hr 30 min
128 GB	23 hr
256 GB	46 hr
512 GB	92 hr

* The times shown above are approximate values, and may change depending on the condition of the card. Also, actual recording times may be shorter than those listed above, depending on the size of the still image or audio file.

* Up to 12 hours of video can be recorded per project.

Main Specifications

■ Video				
Video Processing	4:2:2 (Y/Pb/Pr), 8-bit			
Input Connectors	INPUT 1-2	HDMI type A x 2 * Multi-format Supported		
Output Connectors	MAIN	HDMI type A * Multi-format Supported		
	PREVIEW	HDMI type A		
Input formats	INPUT 1-2	720/59.94p, 720/50p, 1080/59.94i, 1080/50i, 1080/59.94p, 1080/50p		
		SVGA (800 × 600/60 Hz)	XGA (1024 × 768/60 Hz)	
		WXGA (1280 × 800/60 Hz)	FWXGA (1366 × 768/60 Hz)	
		SXGA (1280 × 1024/60 Hz)	SXGA+ (1400 × 1050/60 Hz)	
		UXGA (1600 × 1200/60 Hz)	Full HD (1920 × 1080/60Hz)	
		WUXGA (1920 × 1200/60 Hz)		
		* The refresh rate is the maximum value of each resolution. * Conforms to CEA-861-E, VESA DMT Version 1.0 Revision 11 * The video signal frame rate can be selected at the SYSTEM menu (59.94 Hz or 50 Hz). * 1920 × 1200/60 Hz: Reduced blanking		
Output formats	MAIN	720/59.94p	720/50p	1080/59.94i
		1080/50i	1080/59.94p	1080/50p
	* The video signal frame rate can be selected at the SYSTEM menu (59.94 Hz or 50 Hz).			
	PREVIEW	1080/59.94p		
		1080/50p		
	* The video signal frame rate can be selected at the SYSTEM menu (59.94 Hz or 50 Hz).			
Still Image	Bitmap File (.bmp) 1920 x 1080 pixels, 24-bit color, uncompressed.			
	PNG File (.png) 1920 x 1080 pixels (480 x 270 pixels for title image), 24-bit color, 8-bits alpha channel.			
	* Up to 16 files can be stored in each project.			
Recording mode	Instant Replay Mode	file format	MPEG2-TS	
		CODEC	H.264 High@L.4.1 10 Mbps 8 bit 4:2:0 AAC LC 128 kbps 48 kHz 16 bit Stereo	
		recording/play back mode	resolution priority, frame rate priority	
		* It can be selected at project settings		
Recording media	SD/SDHC/SDXC card			
Video Effects	Composition	PinP, SPLIT		
	Transition	CUT, MIX, WIPE		
	Other	Flip horizontal, Still Image Playback, Test pattern output, Annotation		
■ Audio				
Audio Processing	Sample rate: 24 bits/48 kHz			
Audio formats	Linear PCM, 24 bits/48 kHz, 2 ch			
Input Connectors	INPUT 1-2	HDMI Type A x 2		
	AUDIO IN	RCA phono type		
Output Connectors	MAIN OUT	HDMI Type A		
	PREVIEW OUT	HDMI Type A		
	AUDIO OUT	RCA phono type		
	PHONES	Stereo 1/4-inch phone type		
Input Level	AUDIO IN	-10 dBu (Maximum: +8 dBu)		
Input Impedance	AUDIO IN	15 k Ω		
Output Level	AUDIO OUT	-10 dBu (Maximum: +8 dBu)		
	PHONES	92 mW + 92 mW (32 Ω)		
Output Impedance	AUDIO OUT	1 k Ω		
	PHONES	10 Ω		
Audio Effects	Delay, High pass filter, Compressor, Noise gate, Equalizer, Limiter, Test tone output			
Audio Player	File format: WAV (Linear PCM, 48 kHz/48 kHz, 16 bit, stereo)			
* It can be stored up to 16 files in each Projects				

Other		
Other Connectors	USB HOST port	USB A type (For USB flash drive, Wacom tablet, USB keyboard)
	LAN port	RJ-45, 1000BASE-T (For remote control, FTP)
	RS-232 connector	DB-9 type (Male, for remote control, switcher control)
	CTL/EXP	1/4-inch TRS phone type
	DC IN	
Other Functions	Panel lock function	
	EDID Emulator	
	Export recording files (mp4)	
	Export and Import project archive files	
Display	4.3 inches TFT Color LCD: 480 x 272 dots	
Power Supply	AC adaptor	
Current Draw	3 A	
Power Consumption	36 W	
Operation Temperature	+0 to +40 degrees Celsius	
	+32 to +104 degrees Fahrenheit	
Dimensions	265 (W) x 216 (D) x 87 (H) mm	
	10-7/16 (W) x 8-9/16 (D) x 3-7/16 (H) inches	
Weight (excluding AC adaptor)	2.1 kg	
	4 lbs 11 oz	
Accessories	Startup Guide, Leaflet "USING THE UNIT SAFELY," AC adaptor, Power cord	

* 0 dBu = 0.775 Vrms

* This document explains the specifications of the product at the time that the document was issued. For the latest information, refer to the Roland website.

Dimensions

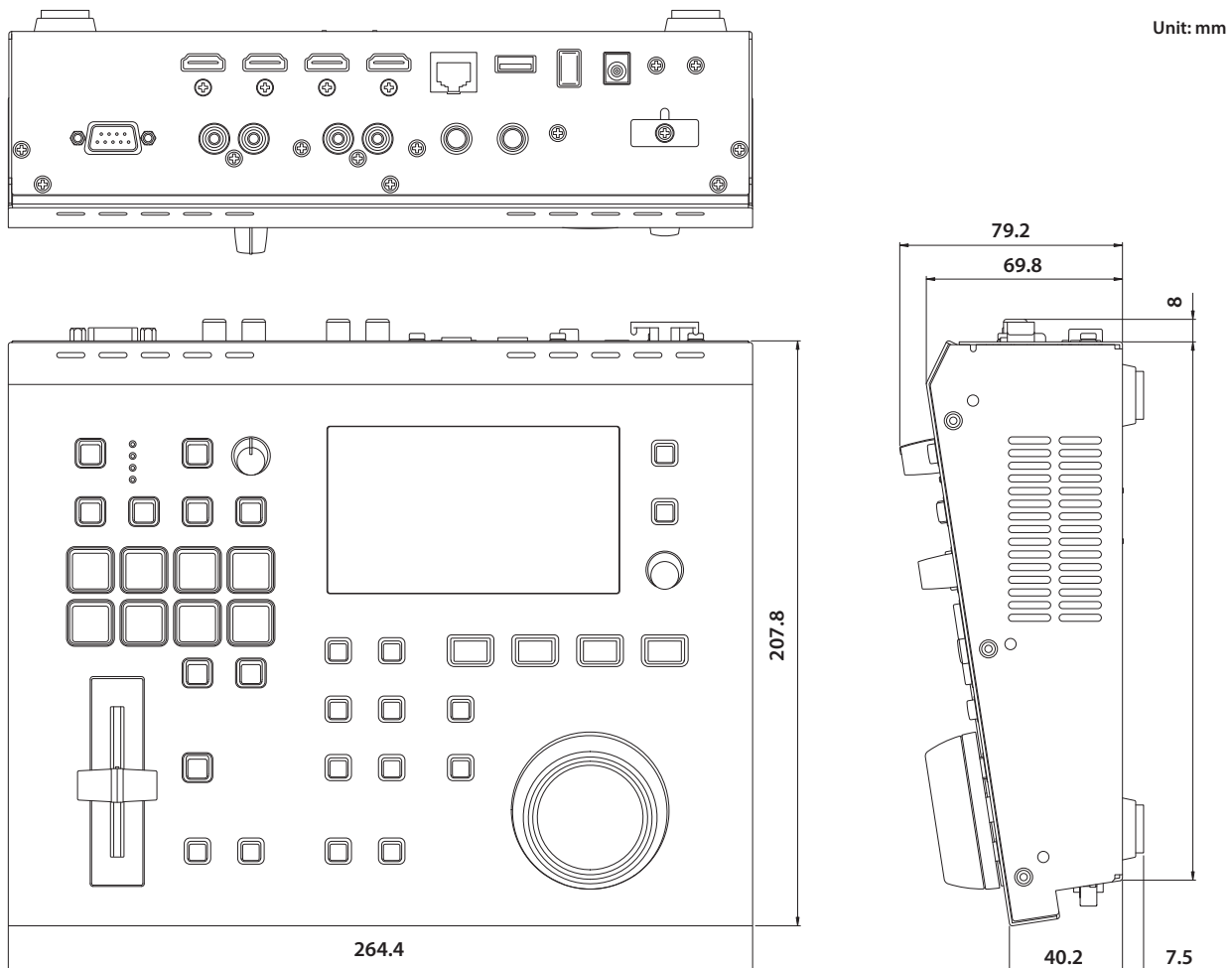

Video Block Diagram

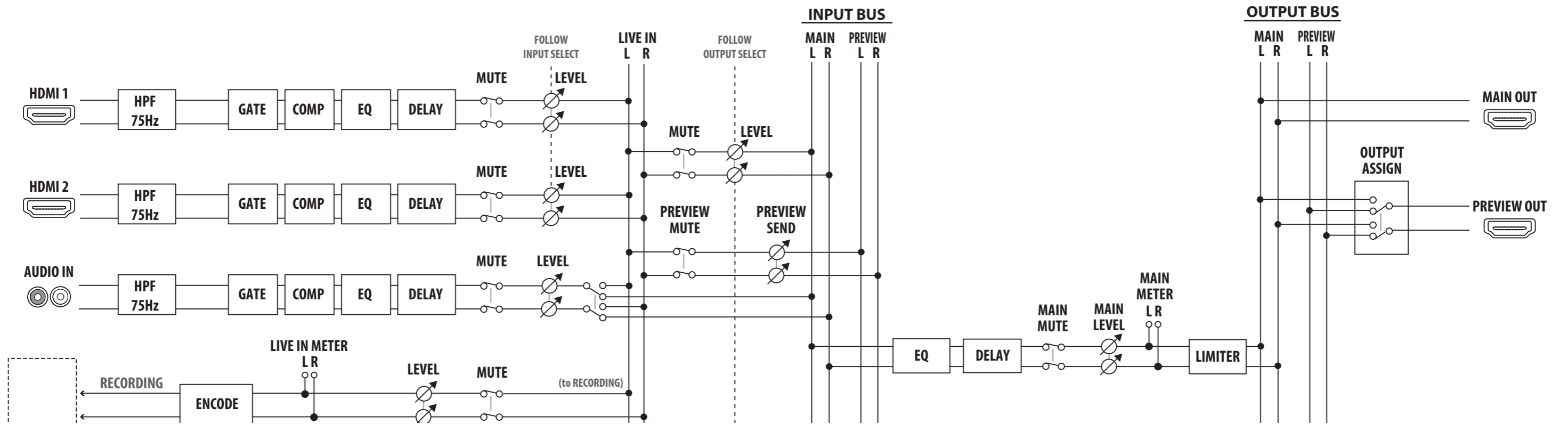

Audio Block Diagram

