

Workhorse[™] Cube[™]

500 Series Power Rack



User Guide



IMPORTANT SAFETY & USER NOTICE - FOR PROFESSIONAL USE

The Radial Workhorse Cube is specifically designed for use by qualified professional audio engineers. The open frame design is not intended for use by consumers or those unfamiliar with this format. Even though the current and voltage levels are relatively low, we recommend that all slots be filled with a module or covers be placed over unfilled slots. This will help protect you from electrical shock.

The Cube™ rack frame is designed to be used with 500 series or what are commonly known as Lunchbox™ modules. The Workhorse has been designed following the framework as outlined by the VPR Alliance as described on the API™ website. Although some manufacturers build modules that are not VPR compliant, they may in fact work with the Cube. Please consult those specific manufacturers for details regarding their compatibility. The Radial Workhorse Open Source Document outlines the required technical specifications for manufacturers that intend to have their modules used in a Workhorse or Cube frame. Compatibility of any modules other than a module made by Radial Engineering Ltd. is the sole responsibility of the user. Please read the Limited Radial Warranty for details. There are no replacement or user serviceable parts inside.



SAFETY NOTICE - NO HOT SWAPPING OF MODULES

Hot Swapping, or exchanging modules while the power is on is not covered under the Radial Limited Warranty. The user is responsible for any damage to the Workhorse Cube or module arising out of hot swapping and the user shall save Radial Engineering Ltd. harmless should any damage occur. *Please consult the Radial Limited Warranty for further details.*

Radial® Workhorse™ Cube™

500 Series Power Rack

Table of Contents	Page
Feature set overview	1
Introduction & basic functions.....	3
Omniport.....	5
Power supply capacity.....	6
Installing the Cube	7
Signal flow and levels	8
Using the Cube.....	9-10
Radial Limited Warranty	Back Cover

Congratulations and thank you for purchasing the Radial Workhorse Cube, an innovative three module card frame designed to bring the excitement of the 500 series modular format to the desktop. This manual describes how to approach using The Cube, how to install modules and mount it in your desk top. We recommend that you take a few minutes to read through it in order to familiarize yourself with the many innovative features that are built in.

To make the manual as easy to understand as possible, we have divided it into several sections. It begins with an overview, then descriptions of each function, ending with some real world applications. Should you have any questions, comments or concerns not covered in these pages, we invite you to log onto the Radial web site at www.radialeng.com and visit the Cube FAQ section. This is where we post the latest updates and answers from users. If you do not find what you need, feel free to send us an email at info@radialeng.com and we will do our best to answer your question as quickly as possible.

Now get ready to bring the fun & excitement of old school analog into your signal path.

FRONT PANEL FEATURE SET



1. **THREE CARD SLOTS:** Both single and double wide 500 series modules will fit in the Workhorse Cube.
2. **CARD SLOT BACK PLANE:** Modules can draw as much current as they need from a shared pool of 500mA through the card slot connector.
3. **DC FILTER CAPS:** On-board DC filtering provides additional power conditioning.
4. **POWER SWITCH WITH LED:** Used to turn the Cube on or off and provides visual power status for the +/- 16 volt module rails.
5. **STEEL CASE:** The Cube's chassis is made from heavy 14 gauge steel to provide extra shielding against stray magnetic fields and RF.

REAR PANEL FEATURE SET

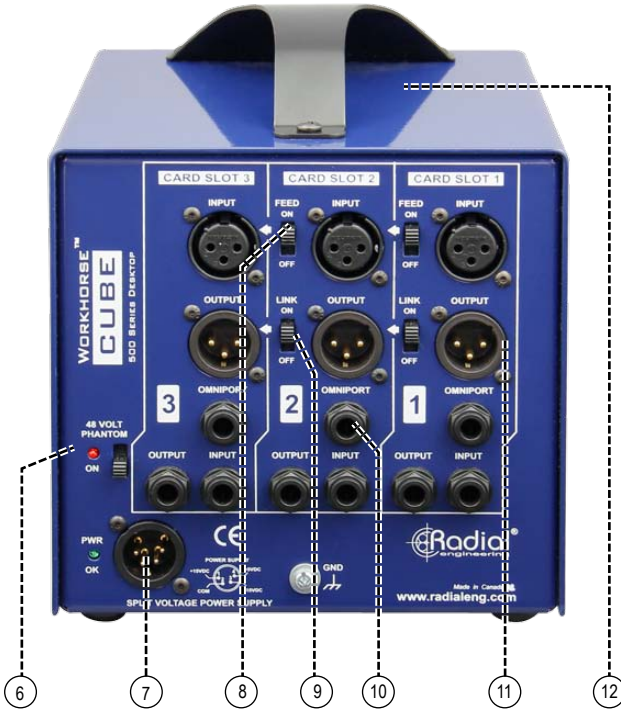

- 6. **48 VOLT** : On/off switch for phantom power. LED indicator will illuminate when active.
- 7. **EXTERNAL POWER**: High current external switching supply delivers 500mA to the card slots.
- 8. **FEED FUNCTION**: Lets you connect one module into the next to set up elaborate channel strips without having to hard patch modules using cables.
- 9. **STEREO LINK**: Makes it easy to pair up modules equipped with a stereo link function in a standard master-slave configuration.
- 10. **OMNIPORT™**: ¼" TRS connectors add functionality to enhance each module's capability as set by the manufacturer.
- 11. **BALANCED I/O**: Follows original XLR I/O format and adds radial parallel ¼" TRS jacks for added connectivity and cross-patching.
- 12. **REMOVABLE HANDLE**: Makes transporting the Cube more convenient around the studio. Can be removed for stacking or recessing into desktop.

INTRODUCTION

The Cube is a three card-slot power frame designed for 500 series modules. Up to three modules may be used at any one time. The Cube routes the modules to the XLR and 1/4" TRS connectors on the rear panel via a 15-pin card-edge receptacle. Radial modules and those that have been designed by other manufacturers to take advantage of the Workhorse's extra features will enjoy the added functionality of the Omniport™.

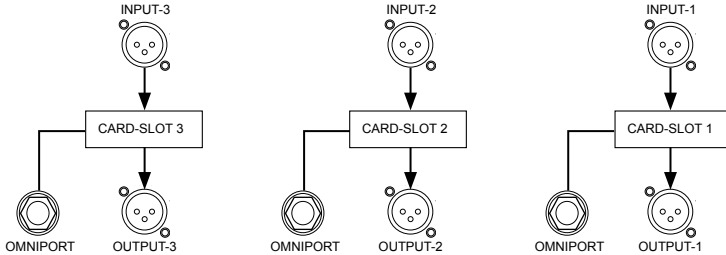

SIGNAL FLOW

This flow chart shows the basic signal routing. The signal comes into the Cube via the rear panel XLR female or 1/4" TRS inputs. Once the signal goes into a module it is processed and sent to the male XLR and parallel 1/4" TRS output. From here the signal can be routed to the next adjacent module via the FEED switch connection as described in the next section.

CARD SLOT I/O CONNECTIONS

Each of the Cube card slots is equipped with XLR and 1/4" TRS inputs and outputs. The input sensitivity will be dependant on the type of module being used. For instance if you are using a microphone preamplifier, the input will of course be suited for a low level microphone. If you are using a dynamic processor like a limiter or an EQ, then the input will usually be set to handle a professional +4dB balanced line-level signal.

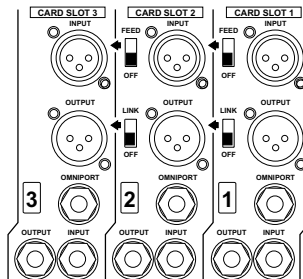

Following 500 series convention, the XLR and TRS outputs usually produce a +4dB balanced line level signal that is able to feed a professional recording system or line level mixing console. Put simply, the input level is determined by the type of module being used while the output level will typically be a balanced +4dB line level signal. *If you use 1/4" mono cables you will unbalance the signal. This will reduce the level by about -6dB but everything will still remain completely functional. Simply adjust the levels to compensate.*

FEED SWITCH

As you delve further into the functionality of the 500 series, you will find that the modular format allows all kinds of connectivity options. With older 500 series racks, connections between modules were done using an XLR cable whereby the output from one module would plug into the input of another. The Cube simplifies the process by introducing a FEED switch on the rear panel. This connects the balanced output of one module to the adjacent module to the immediate left when viewing the rear panel.

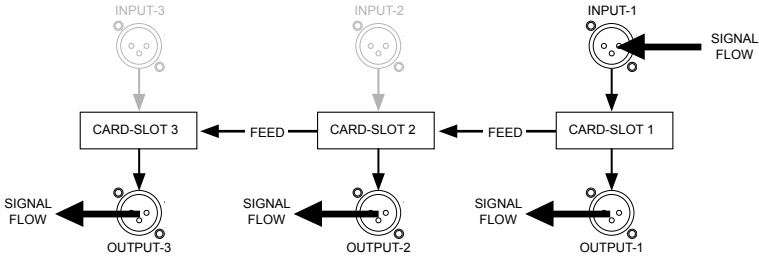

The FEED switch allows you to daisy chain a series of adjacent modules making it easy to create a customized channel strip whereby a mic preamp feeds an EQ which in turn could feed a compressor. Changing the order is simply a matter of relocating the modules or patching using an XLR cable. The UP position turns the FEED connection on.

The 1/4" TRS connectors are also great for cross-patching between modules. Think of it like a patchbay. Simply take the output from one, feed it into another and then jump back. This opens many creative options and loads more fun.

STEREO LINK SWITCH

Card-slots one and two are equipped with a LINK switch. The LINK function allows modules that are 'stereo ready' to be linked together. A typical example would be using two limiters on a stereo track where you want the dynamics to be the same for both channels.

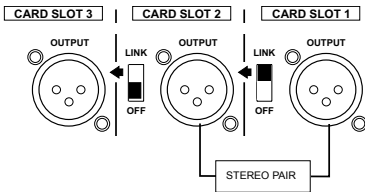

CARD-SLOTS 1 & 2 LINKED FOR STEREO OPERATION

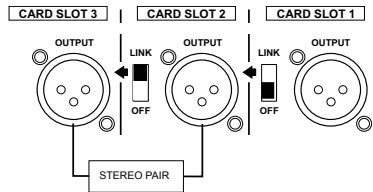

CARD-SLOTS 2 & 3 LINKED FOR STEREO OPERATION

OMNIPORT

Omniport™ is a special ¼” TRS jack located on the rear panel that has been left ‘open’ to allow the module to perform a unique task. In other words, depending on the type of module, the manufacturer can assign the Omniport to perform a function that may be most appropriate. This could be a key input on a gate, a TRS insert or maybe a buffered output. As the Omniport function is determined by the module, you will need to consult the module manufacturer’s specification for details on how it was designed to be used.

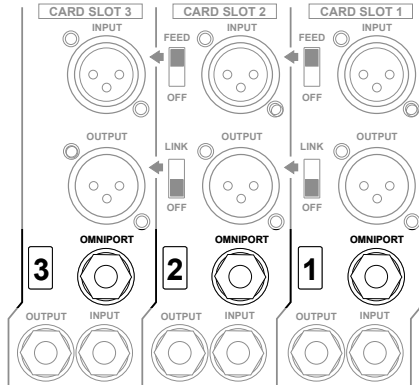

Radial Modules Omniport Assignment:

Module	Omniport function
PowerPre:	Instrument input
JDV-Pre:	Line level output (low-Z out for live touring)
X-Amp:	Instrument input
PhazeQ:	Balanced direct out (original dry signal out)
JDX:	Direct box output (low-Z out for live touring)
EXTC:	Send & receive insert for patch bay
Komit:	Compressor key (side chain) input
Shuttle:	Extra insert loop
Q3:	TRS send & receive connection
Tank Driver:	Second (alternate) spring reverb
PowerTube:	Instrument input

POWER SUPPLY

The Cube employs an external power supply that will automatically convert the various voltages used around the world and regulate them before sending the power to the Cube. A standard male IEC/EIN power input connector makes it easy to travel as you need only change the cable to suit the local power connector type. The connection between the power supply is a 4-pin locking XLR.

As soon as you connect the Cube, a rear panel LED will illuminate to let you know the power supply is active. A front-panel power switch and LED indicator will illuminate when turned on. An additional rear panel LED indicator monitors the 48V phantom power supply when it is switched on. Turning phantom power on or off is global and applied to all card slots. For modules such as dynamic processors or EQs that do not use phantom power the module simply ignores the phantom power as if it were not there.

POWER SHARING

The Cube’s power supply produces 500 milliamps (mA) of current that is shared between the card slots. So for instance, if you have a power-hungry tube preamp in slot 1 that requires 250 milliamps of current, you still have 250 milliamps of current left to power the other two card slots. Considering most 500 series modules use between 40 and 130 milliamps of current, it is unlikely you will ever exceed the Cube’s available power.

Example A:

Slot-1	Radial PowerTube tube preamp	Draw: 235mA
Slot-2	Radial Q3 induction coil EQ	Draw: 25mA
Slot-3	Radial Komit compressor	Draw: 130mA

Total Current Draw: 390mA (110mA to spare!)

Example B:

Slot-1	Radial PowerPre preamp	Draw: 130mA
Slot-2	Radial Q3 induction coil EQ	Draw: 25mA
Slot-3	Radial Komit compressor	Draw: 130mA

Total Current Draw: 295mA (205mA to spare!)

Note: The original API™ spec calls for an average of 130mA for each slot. The Cube exceeds this with a total of 500mA or 166mA when current draw is divided equally between the three card slots.

SETTING UP THE CUBE

For desktop use, four rubber feet are included in the packaging. To install the rubber feet, turn the Cube upside down and insert into the four open holes on the bottom.

The Cube also comes with a convenient carry handle that makes it easier to move the Cube around the studio. You will find three Phillips screws in the package with the handle for mounting. Leave the handle off if you want to stack stuff on top.

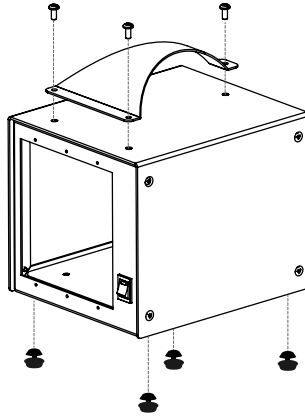

INSTALLING MODULES IN THE CUBE

When making any electrical connection, it is always safer to do so with the power disconnected. The Cube's internal power circuit is equipped with protective measures intended to provide a margin of safety should a module exchange be performed with the power on. However, the Cube is not designed to allow repeated insertion and removal of modules while the power supply is active. Always power off the Cube before exchanging modules.

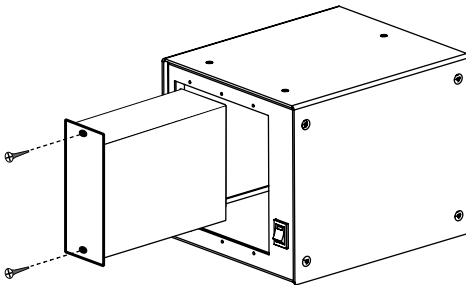

SIGNAL FLOW AND LEVELS

Because the Cube is modular, it can accept a multitude of different devices into its card slots. This also means that you need to understand the signal flow so that you can be sure what you want to do will work. In the world of audio there are basically four low level signal groups to contend with before you get to high power output levels such as those produced by power amplifiers to drive loudspeakers.

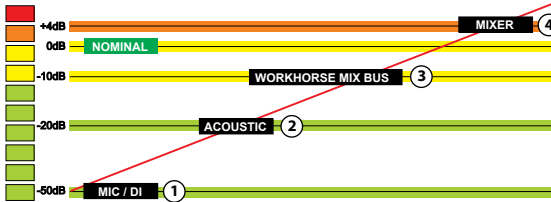

1. **MIC LEVEL RANGE:** Microphones and direct boxes produce the weakest signals. These typically range from -60dB to -40dB depending on type. Some such as ribbon microphones can be as low as -70dB while condenser mics will generally be at the top end of this range. With a Cube, one would connect a microphone to a preamp like the PowerPre™. This would elevate the mic-level signal to produce a +4dB line-level at the XLR output.
2. **INSTRUMENT LEVEL RANGE:** The output levels produced by instruments can range widely. A single coil electric guitar can produce as little as -40dB while an electronic keyboard, sampler or digital piano is capable of producing -10dB or more. For low level instruments, 500 series modules like the JDV™ amplify the signal to produce a +4dB signal level at the XLR output for direct recording.
3. **UNBALANCED -10dB LINE LEVEL RANGE:** Unbalanced outputs from CD players, keyboards, mixers and home hi-fi components are usually specified at -10dB and are often referred to as consumer line-level. These connect to a mic preamp. If too loud, one simply engages a pad.
4. **BALANCED +4dB LINE LEVEL RANGE:** This is the professional line level that comes from a recording system and is normally the level that goes in and out of EQs and compressors so most 500 series modules employ a +4dB signal level.

Matching the output level of one device to the input of the next will help you avoid distortion and maximize signal-to-noise. For instance, using a +4dB output to drive a -10dB input could overload the input and cause distortion. Conversely, a -10dB output may not have enough gain to drive the input of a +4dB device resulting in a higher noise floor.

Because each of the Cube slots is equipped with a balanced line level input and a balanced line level direct output (depending on the module), you are pretty much free to interconnect modules or route signals to other devices using standard XLR patch cables. Once you start working with the Cube you will quickly come to understand all of the capabilities and how easy it is to use.

USING THE CUBE

Because the Cube is a modular frame, there are practically no limits as to what kind of signal chain you can create. For instance, it can be loaded with Radial modules set up for analog effects routing for your workstation, a customized channel strip, an instrument preamp for live recording or as part of a play-back and overdub system.

As with all electronic equipment, **turn off the power and turn down levels** before making connections. This will avoid the loud on-off transient that can damage equipment or blow speakers. Plugging in a module is merely a matter of sliding it into the Cube and carefully aligning the 15-pin card edge connector. Once plugged in, secure the module in place using the supplied Phillips screws. After the module is connected, it will automatically route the signal from the rear panel connectors to and from the module.

Simple XLR I/O

The first step in approaching the Cube is going back to the original Lunchbox™. This device was basically a steel enclosure that fed power to a number of modules. Connecting to and from modules was done using the XLR connector that was associated with each card slot. The Cube retains all of this connectivity while adding the convenience of ¼" TRS connectors.

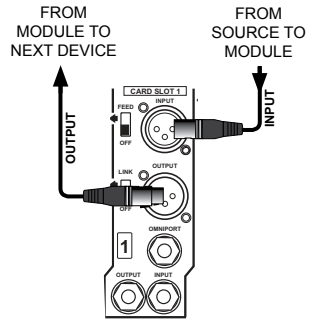

Setting Up A Channel Strip

The next stage is using several modules together to create a channel strip. For instance, when recording a vocal track, you may want to run a mic preamp into an EQ to add some presence and then into a compressor-limiter so that the track stays out of the 'red'.

Using the old system, you would connect the microphone to the mic preamp using a standard XLR cable. The mic preamp output would then connect to the EQ which in turn would connect to the limiter. The direct XLR output from the limiter would then be sent to the recording system.

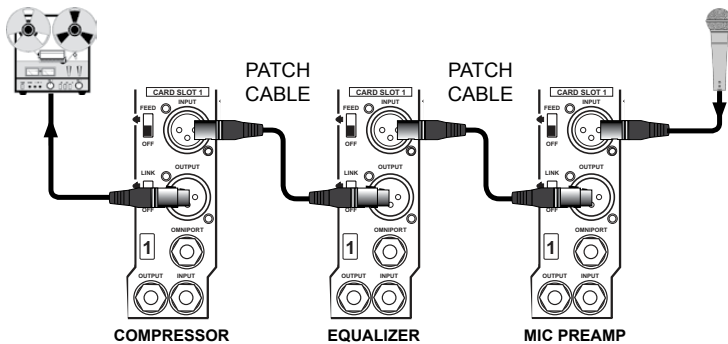

The Cube simplifies the process with a FEED switch that replaces inter-module patch cables. Instead of using an XLR cable, you simply push the FEED switch into the UP position and it routes the signal to the adjoining module's input. When engaged, the FEED function sends the signal to the next module working from left to right (front view). Because the FEED function is tied to the XLR connector, it will work with new Radial modules and older 500 series modules.

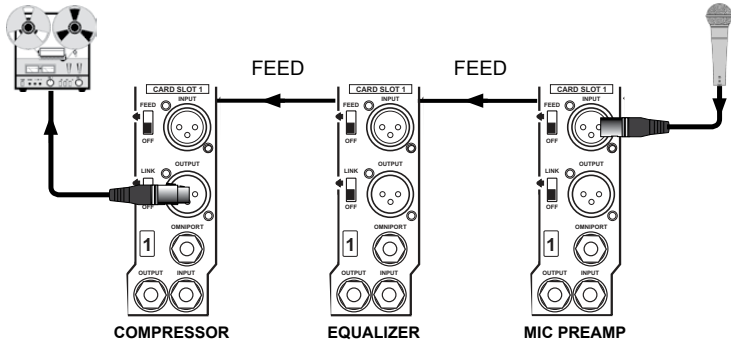

Once you get started, you will soon find all kinds of new and exciting ways to patch modules. You could, for instance, use the feed switch to connect one module into the next while using a TRS cable to simultaneously patch the signal to the third card-slot. The image below shows how this is done. The mic signal has been split into two signal paths that can be processed separately.

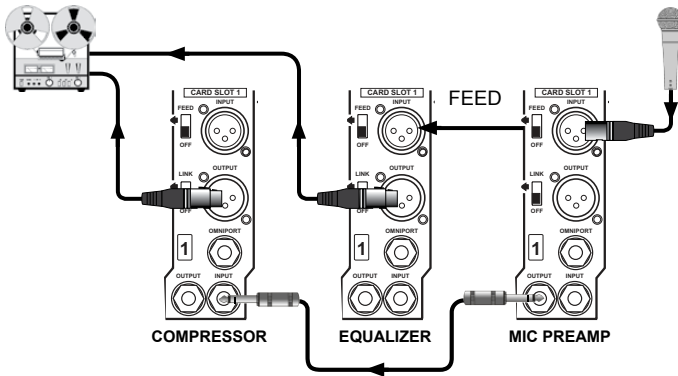

THREE YEAR TRANSFERABLE LIMITED WARRANTY

RADIAL ENGINEERING LTD. ("Radial") warrants this product to be free from defects in material and workmanship and will remedy any such defects free of charge according to the terms of this warranty. Radial will repair or replace (at its option) any defective component(s) of this product (excluding finish and wear and tear on components under normal use) for a period of three (3) years from the original date of purchase. In the event that a particular product is no longer available, Radial reserves the right to replace the product with a similar product of equal or greater value. In the unlikely event that a defect is uncovered, please call 604-942-1001 or email service@radialeng.com to obtain an RA number (Return Authorization number) before the 3 year warranty period expires. The product must be returned prepaid in the original shipping container (or equivalent) to Radial or to an authorized Radial repair center and you must assume the risk of loss or damage. A copy of the original invoice showing date of purchase and the dealer name must accompany any request for work to be performed under this limited and transferable warranty. This warranty shall not apply if the product has been damaged due to abuse, misuse, misapplication, accident or as a result of service or modification by any other than an authorized Radial repair center.

THERE ARE NO EXPRESSED WARRANTIES OTHER THAN THOSE ON THE FACE HEREOF AND DESCRIBED ABOVE. NO WARRANTIES WHETHER EXPRESSED OR IMPLIED, INCLUDING BUT NOT LIMITED TO, ANY IMPLIED WARRANTIES OF MERCHANTABILITY OR FITNESS FOR A PARTICULAR PURPOSE SHALL EXTEND BEYOND THE RESPECTIVE WARRANTY PERIOD DESCRIBED ABOVE OF THREE YEARS. RADIAL SHALL NOT BE RESPONSIBLE OR LIABLE FOR ANY SPECIAL, INCIDENTAL OR CONSEQUENTIAL DAMAGES OR LOSS ARISING FROM THE USE OF THIS PRODUCT. THIS WARRANTY GIVES YOU SPECIFIC LEGAL RIGHTS, AND YOU MAY ALSO HAVE OTHER RIGHTS, WHICH MAY VARY DEPENDING ON WHERE YOU LIVE AND WHERE THE PRODUCT WAS PURCHASED.



True to the Music
www.radialeng.com

Radial Engineering Ltd.
1588 Kebet Way, Port Coquitlam BC V3C 5M5
tel: 604-942-1001 • fax: 604-942-1010
info@radialeng.com • www.radialeng.com



Radial Workhorse™ Cube™ User Guide - Part # R870 1260 00 / 06-2018
Copyright © 2018 Radial Engineering Ltd. Specifications and appearance
are subject to change without notice.

Made in Canada 